



## **Dedicated To My Wife**

A family tree, steadfast and wide,  
Its branches reaching far and high.  
Each leaf a story, each twig a tie,  
Yet one fell silent when you said goodbye.

Your laughter danced like the morning breeze,  
Now stilled among the solemn trees.  
A limb once strong, now breaks away,  
Yet roots remember every day.

Your love remains, in bark and vein,  
A whispered echo through the rain.  
Though absence aches, the tree will grow,  
For in its heart, your light still glows.

In the story of our families, we are reminded that the richest inheritance we share is not in wealth, but in love. Our true strength lies not in titles or possessions, but in the unspoken connections that bind us. Let us carry forward a legacy built on kindness, respect, and a love that knows no bounds. As we continue to grow, may we always remember that the most valuable measure of who we are is the way we treat one another—with compassion, care, and unwavering support. This is the foundation of our families' future: a love that endures beyond all things.

# **Branches of Our Tree**

**ANDREW JOHN JAMESON**

**AND**

**JANE ELIZABETH JAMESON**



"The Complete Genealogy Reporter"  
© 2006-2025 Nigel Bufton Software



**Published by:**

Cheesy Productions Limited  
123 Dairy Lane,  
Cheddar Grove, CH8 1QJ  
United Kingdom

**Printed by:**

DoxDirect Limited  
42 Paper Jam Avenue,  
Stapleton Business Park,  
Inkyton, Printfordshire, PX1 4PR  
United Kingdom

**Cover Design by:** Andrew Jameson

**ISBN: 978-1-23456-789-0**

**All rights reserved ©2025 Andrew Jameson & Rachel Slack**

No part of this book may be reproduced, stored in a retrieval system, or transmitted in any form or by any means—electronic, mechanical, photocopying, recording, or otherwise—without the prior written permission of the publisher, except in the case of brief quotations embodied in critical articles or reviews.

This book is a heartfelt exploration of the Jameson / Woods family trees, capturing the roots, branches, and memories of Jane’s life and legacy.

*“To live in hearts we leave behind is not to die.”*

Thomas Campbell (1777—1844)

**Special Thanks**

A heartfelt thank you to Rachel Slack for her dedication and meticulous attention to detail. Your work on this project helped bring this story to life.

We’d also like to thank Jane, whose ability to find humour in every situation continues to inspire us all—especially during moments like this when we most need a laugh.

**First Publication March 2025**

United Kingdom  
Cheesy Productions Limited

*“A family tree is rooted in love, branching through generations, and blossoming with endless possibilities.”*

Andrew Jameson

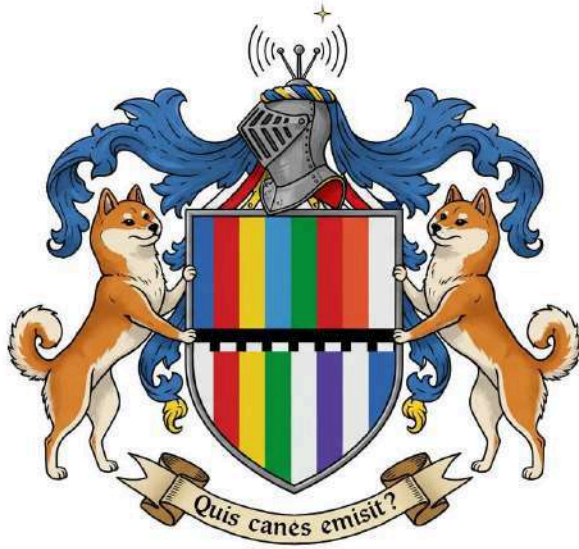

**A Genealogy Report For**

**ANDREW JOHN JAMESON**



ROOCROFT'S  
**TICS**  
Relief in a "Tic"  
THROAT AND CHEST



**Roller Frame Sweet Press (circa 1865)**

**Manufactured by BCH (Rochdale) Ltd.**

**Purchased by Edward Roocroft<sup>169</sup>**



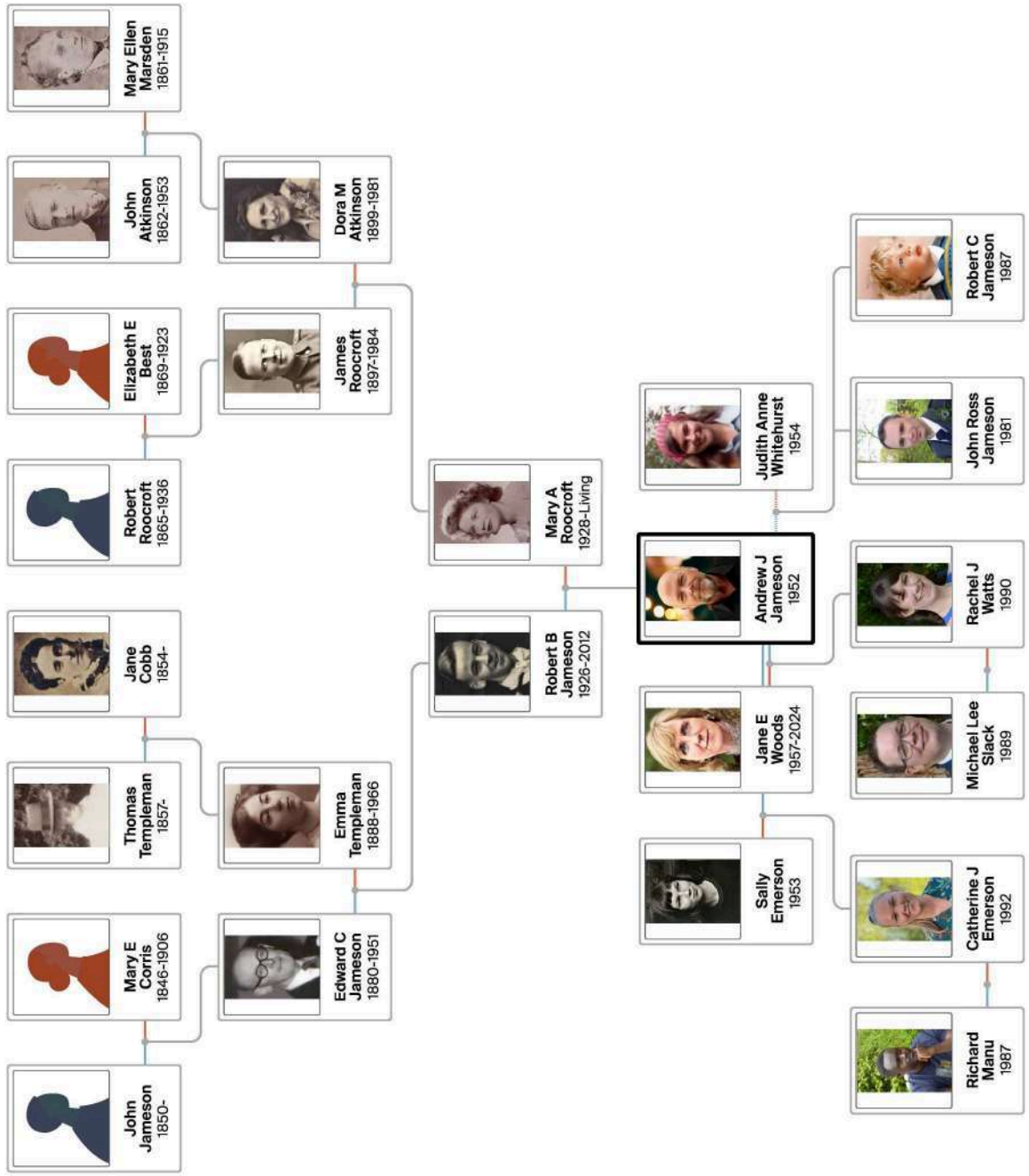



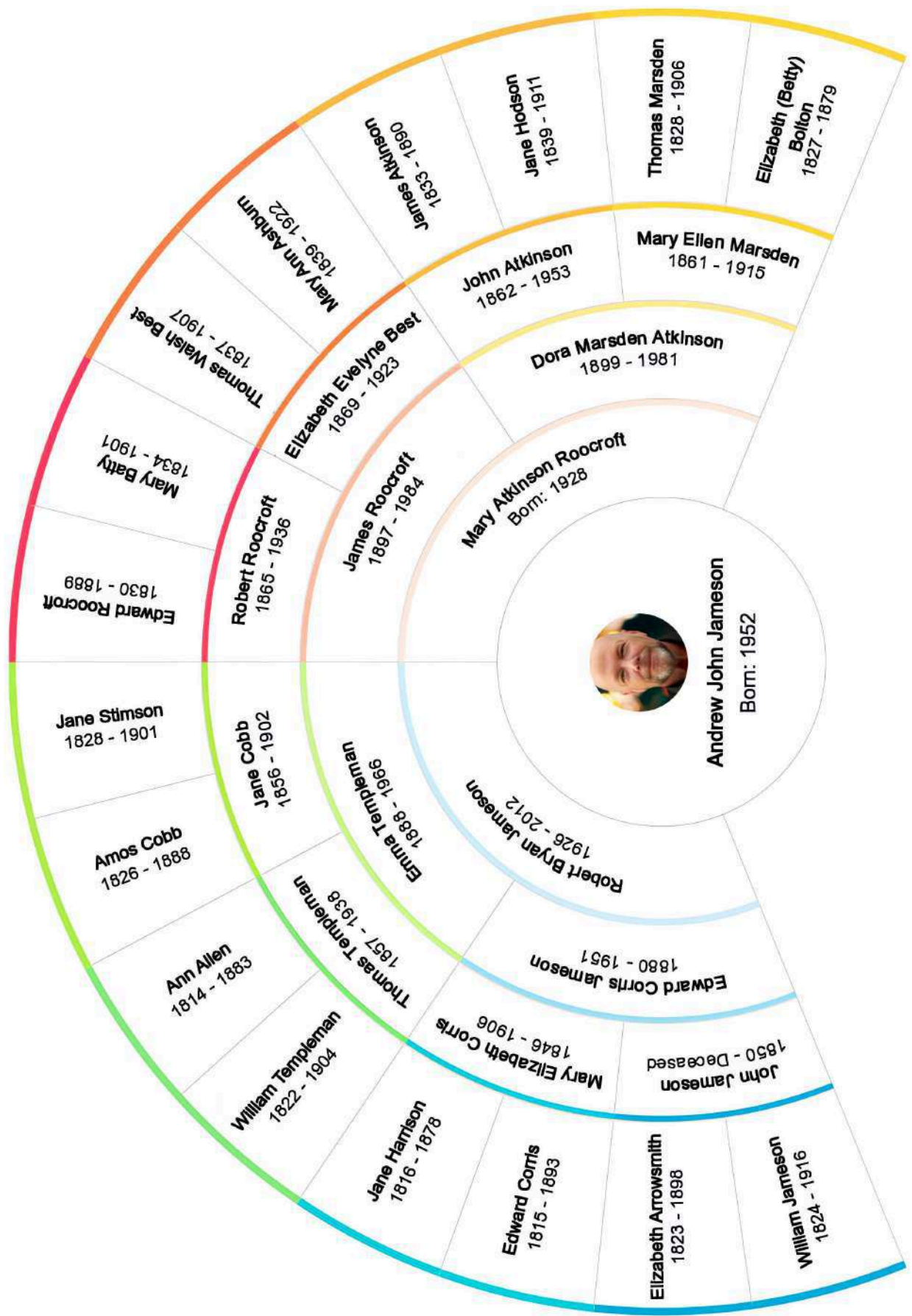

**Andrew John Jameson**  
Born: 1952

**Mary Atkinson Roorcroft**  
Born: 1928

**John Atkinson**  
1862 - 1953

**Mary Ellen Marsden**  
1861 - 1915

**Dora Marsden Atkinson**  
1899 - 1981

**James Roorcroft**  
1897 - 1984

**Elizabeth Evelynne Best**  
1869 - 1923

**Robert Roorcroft**  
1865 - 1936

**Thomas Walsh Best**  
1837 - 1907

**Mary Batty**  
1834 - 1901

**Edward Roorcroft**  
1830 - 1889

**Robert Bryan Jameson**  
1926 - 2012

**Edward Cortis Jameson**  
1880 - 1951

**John Jameson**  
1850 - Deceased

**Mary Elizabeth Cortis**  
1846 - 1906

**Emma Templeman**  
1888 - 1966

**Thomas Templeman**  
1837 - 1938

**Ann Allen**  
1814 - 1883

**Amos Cobb**  
1826 - 1888

**Jane Stimson**  
1828 - 1901

**Jane Cobb**  
1856 - 1902

**Jane Harrison**  
1816 - 1878

**Edward Cortis**  
1815 - 1893

**Elizabeth Arrowsmith**  
1823 - 1898

**William Jameson**  
1824 - 1916

**William Templeman**  
1822 - 1904



- 1. INTRODUCTION**
- 2. PATERNAL ANCESTRY**
- 3. MATERNAL ANCESTRY**
- 4. DESCENDANTS**
- 5. DIRECT RELATIONS**
- 6. FAMILY TREES**
- 7. INDEX OF PLACES**
- 8. INDEX OF DATES**
- 9. INDEX OF ANNIVERSARIES**
- 10. RELATIONSHIP PATHS**
- 11. INDEX OF INDIVIDUALS**



## 1. INTRODUCTION

### STATISTICS

This document reports the details of 270 individuals, of which 140 are male and 130 are female. Of the 123 individuals with recorded birth and death dates, the average lifespan was 69.7 years. Of these, 58 males averaged 70.2 years, and 65 females averaged 69.3 years.

The longest living male was John Derek Wood<sup>95</sup>, who died aged 93. The longest living female was Peggy (Margaret) Huntington<sup>243</sup>, who died aged 93.

Mary Atkinson Roorcroft<sup>80</sup> has reached the age of 96 and is still living, making her the longest living person recorded in this document.

There are 120 families reported. 86 of these families are reported as having children, with an average of 2 children per family.

### THE NARRATIVE SECTIONS

The "Direct Relations" section reports the details of individuals who have a direct family connection to Andrew John Jameson<sup>40</sup>. The section is broken into sub-sections for each generation, within which the individuals are listed in order of closeness of relationship. The sequence numbers are used throughout the document to cross-reference back to the detailed entry of an individual.

With a narrative section, each generation is shown as a separate subsection, within which the individuals are listed in order of the closeness of their relationship to Andrew John Jameson<sup>40</sup>.

### FAMILY TREES SECTION

Each family tree shows the reported children, parents, grandparents and great-grandparents of a family group. In order to reduce redundancy, any family group which is wholly included within another family tree may not be reported separately.

Above each of the great-grandparent boxes (top row), a continuation family tree reference number is shown if the great-grandparent is recorded as a child in the continuation tree. A continuation reference number is also shown to the left of a grandparent or parent box if that individual has siblings reported in the continuation tree; and beneath a child box (bottom row) if that individual has children reported in the continuation tree.

In cases of multiple marriages, a continuation reference number preceded by "=" is shown to the right of a parent box. This number references the previous and/or next tree in which that individual is shown with another partner.

**2. PATERNAL ANCESTRY**

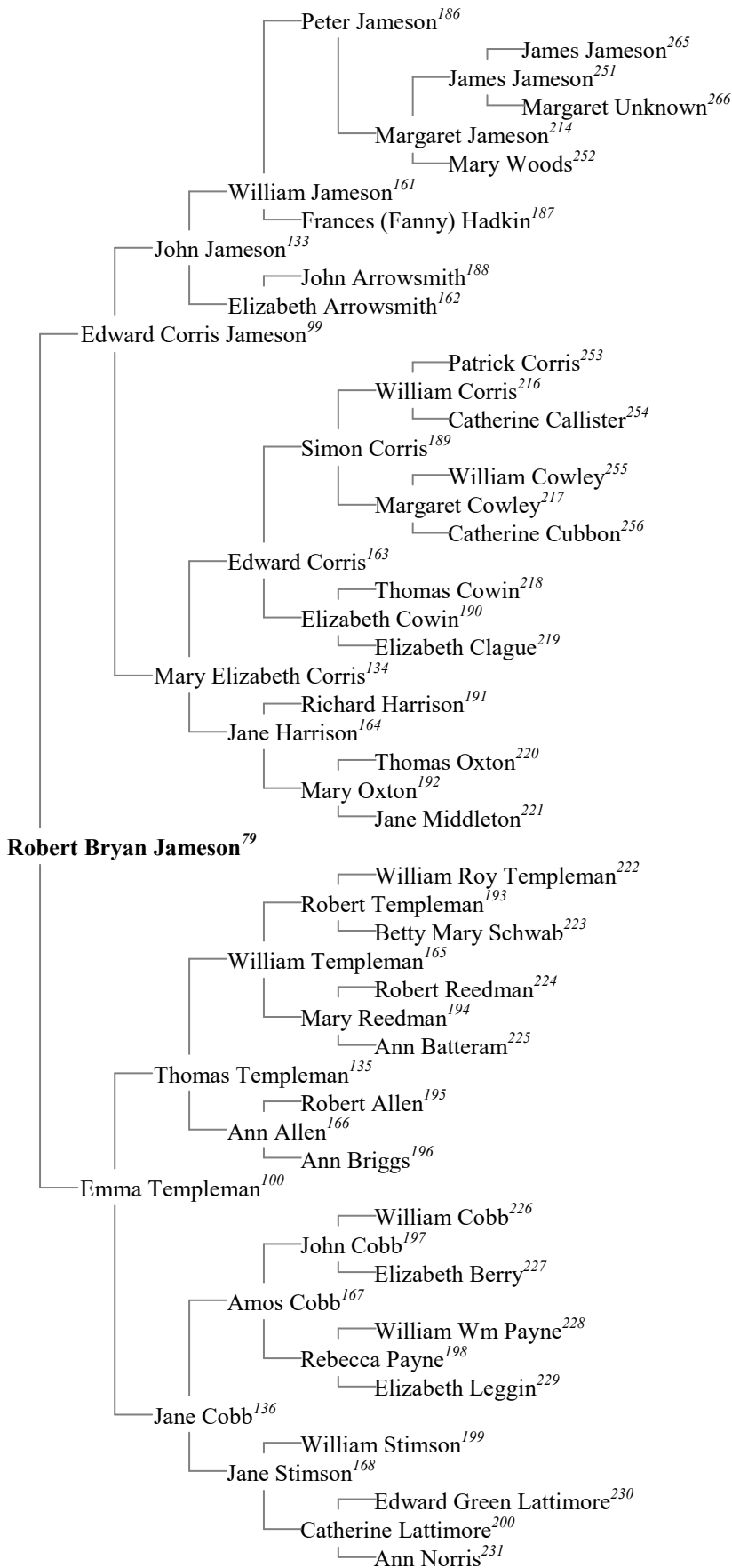

**3. MATERNAL ANCESTRY**

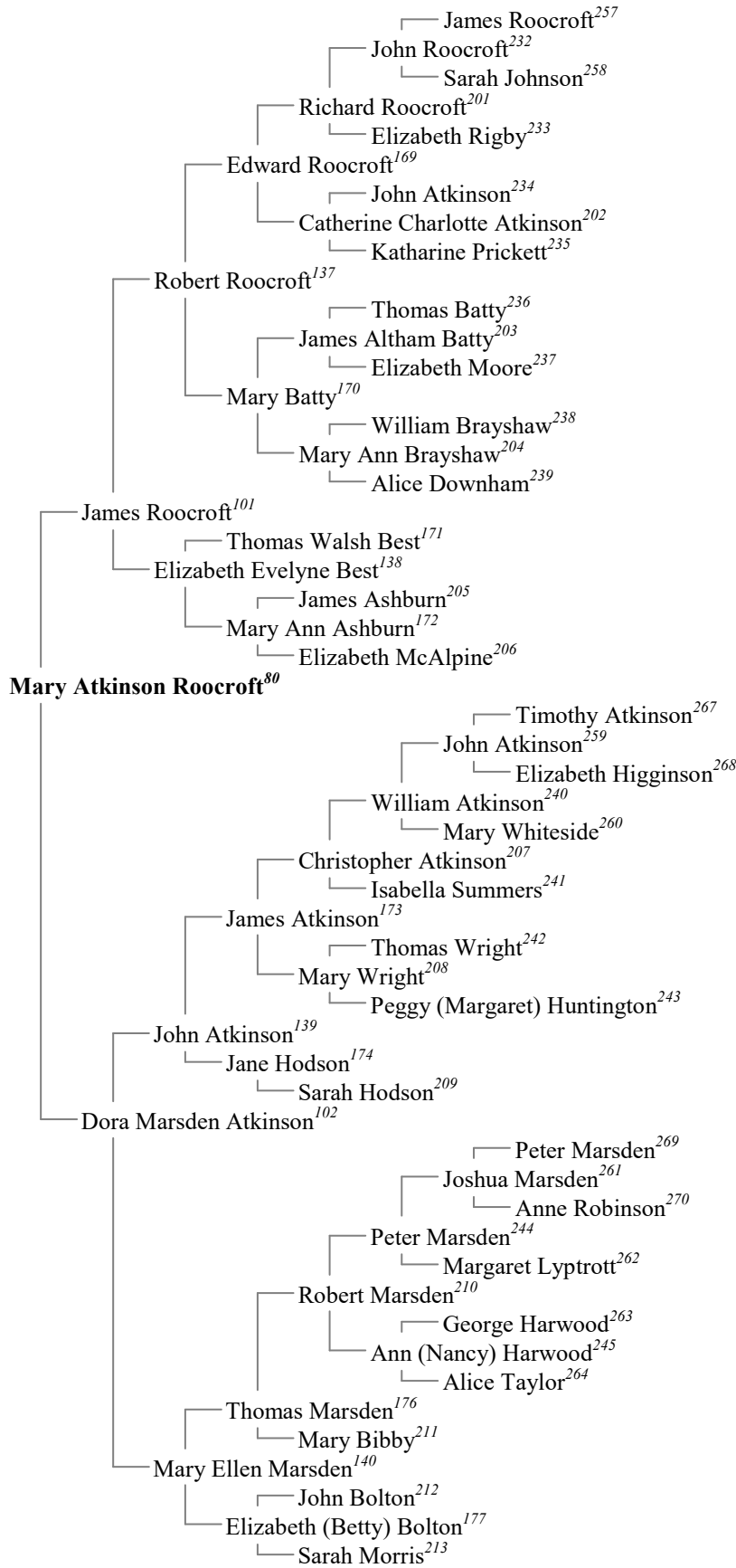

**4. DESCENDANTS**

Andrew John Jameson<sup>40</sup>  
+Judith Anne Whitehurst<sup>41</sup>  
├── John Ross Jameson<sup>6</sup>  
└── Robert Cameron Jameson<sup>7</sup>  
+Jane Elizabeth Woods<sup>42</sup>  
├── Rachel Jane Watts<sup>8</sup>  
+Sally Emerson<sup>43</sup>  
└── Catherine Jane Emerson<sup>10</sup>



**Jameson Shop 1930 (Edward, Corris Jameson & Mrs. Ellen Kirkman)**

## **5. DIRECT RELATIONS**

### **Generation of Grandchildren**

1. MS. WARDLE (Andrew's cousin, twice removed<sup>165</sup>) was born to Timothy James Wardle<sup>24</sup> and Jacqueline A Thornes<sup>25</sup>, as shown in family tree 5.
2. MS. WARDLE (Andrew's cousin, twice removed<sup>164</sup>) was born to Timothy James Wardle<sup>24</sup> and Jacqueline A Thornes<sup>25</sup>, as shown in family tree 5.
3. MR. SOMERSALL (Andrew's cousin, twice removed<sup>162</sup>) was born to James Richard Somersall<sup>26</sup> and Paula Elizabeth Anderson<sup>27</sup>, as shown in family tree 6.
4. NATHAN JAMES SOMERSALL (Andrew's cousin, twice removed<sup>163</sup>) was born in June 1997, in Durham Northern, Durham, to James Richard Somersall<sup>26</sup> and Paula Elizabeth Anderson<sup>27</sup>, as shown in family tree 6.
5. TRISTAN THOMAS SOMERSALL (Andrew's cousin, twice removed<sup>161</sup>) was born in August 2003, in Durham Central, Durham, to James Richard Somersall<sup>26</sup> and Paula Elizabeth Anderson<sup>27</sup>, as shown in family tree 6.

### **Generation of Children**

6. JOHN ROSS JAMESON (Andrew's son<sup>9</sup>, see Descendants) was born on 16 May 1981, in Raigmore, Inverness, to Andrew John Jameson<sup>40</sup> and Judith Anne Whitehurst<sup>41</sup>, as shown in family tree 9. In 2007, aged about 26, he resided in Andover, Hampshire, England, United Kingdom. In 2013, aged about 32, he resided in Andover, Hampshire, England.



7. ROBERT CAMERON JAMESON (Andrew's son<sup>8</sup>, see Descendants) was born on 10 August 1987, in Winchester, Hampshire, to Andrew John Jameson<sup>40</sup> and Judith Anne Whitehurst<sup>41</sup>, as shown in family tree 9.



8. RACHEL JANE WATTS (Andrew's daughter<sup>11</sup>, see Descendants) was born on 24 March 1990, in Preston, Lancashire, England, to Martin Craig Watts and Jane Elizabeth Woods<sup>42</sup>. '2008–2010' she resided in Chorley, Lancashire, England, United Kingdom.



9. MICHAEL LEE SLACK (Andrew's son-in-law<sup>32</sup>) was born on 3 March 1989, in Sutton In Ashfield, Nottinghamshire, England. '2007–2008' he resided in Telford, Shropshire, England, United Kingdom. Michael Lee Slack, aged 26, married Rachel Jane Watts<sup>8</sup>, aged 25, on 10 October 2015 in London Zoo, Westminster, London, England. See family tree 1.



10. CATHERINE JANE EMERSON (Andrew's daughter<sup>10</sup>, see Descendants) was born on 19 November 1992, in Hackney, London, England, to Andrew John Jameson<sup>40</sup> and Sally Emerson<sup>43</sup>, as shown in family tree 11.



11. RICHARD MANU (Andrew's son-in-law<sup>33</sup>) was born in 1987.



Richard Manu, aged about 30, married Catherine Jane Emerson<sup>10</sup>, aged 25, on 7 April 2018 in Ghana. See family tree 2.

12. ROBERTO CAMBLOR JAMESON (Andrew's nephew<sup>28</sup>) was born on 26 March 1986, in Madrid, Spain, to César Camblor<sup>45</sup> and Linda Jane Jameson<sup>44</sup>, as shown in family tree 13.



13. NICHOLAS CAMBLOR JAMESON (Andrew's nephew<sup>24</sup>) was born on 10 February 1988, in Santander, Cantabria, Spain, to César Camblor<sup>45</sup> and Linda Jane Jameson<sup>44</sup>, as shown in family tree 13.



14. MATEO CAMBLOR JAMESON (Andrew's nephew<sup>27</sup>) was born on 13 March 1991, in Santander, Cantabria, Spain, to César Camblor<sup>45</sup> and Linda Jane Jameson<sup>44</sup>, as shown in family tree 13.



15. SOFIA CAMBLOR JAMESON (Andrew's niece<sup>30</sup>) was born on 13 September 1993, in Santander, Cantabria, Spain, to César Camblor<sup>45</sup> and Linda Jane Jameson<sup>44</sup>, as shown in family tree 13.



16. LINDA CAMBLOR JAMESON (Andrew's niece<sup>31</sup>) was born on 2 November 1995, in Santander, Cantabria, Spain, to César Camblor<sup>45</sup> and Linda Jane Jameson<sup>44</sup>, as shown in family tree 13.



17. LINDA CHARLOTTE VICKERS (Andrew's niece<sup>29</sup>) was born on 20 November 1985, in Bolton, Lancashire, England, to William Leslie Vickers<sup>47</sup> and Kathryn Mary Jameson<sup>46</sup>, as shown in family tree 14.



18. ADAM BAIRD-FRASER (Andrew's niece's husband<sup>75</sup>).



Adam Baird-Fraser married Linda Charlotte Vickers<sup>17</sup>. See family tree 3.

19. THOMAS WILLIAM VICKERS (Andrew's nephew<sup>25</sup>) was born on 15 May 1987, in Bolton, Lancashire, England, to William Leslie Vickers<sup>47</sup> and Kathryn Mary Jameson<sup>46</sup>, as shown in family tree 14.





20. BENJAMIN JAMES VICKERS (Andrew's nephew<sup>26</sup>) was born on 7 April 1989, in Bolton, Lancashire, England, to William Leslie Vickers<sup>47</sup> and Kathryn Mary Jameson<sup>46</sup>, as shown in family tree 14.



21. ROBIN MARCUS WARDLE (Andrew's cousin, once removed<sup>98</sup>) was born in January 1969, in Bolton, Lancashire, England, to Roy Wardle<sup>49</sup> and Margaret Jameson<sup>48</sup>, as shown in family tree 15.
22. ELIZABETH J STONE (Andrew's cousin's wife, once removed<sup>160</sup>).  
Robin Marcus Wardle<sup>21</sup>, aged about 23, married Elizabeth J Stone in 1992 in Bromley, Greater London, United Kingdom. See family tree 4.
23. EDWARD JONATHAN WARDLE (Andrew's cousin, once removed<sup>99</sup>) was born in January 1971, in Bolton, Lancashire, England, to Roy Wardle<sup>49</sup> and Margaret Jameson<sup>48</sup>, as shown in family tree 15.
24. TIMOTHY JAMES WARDLE (Andrew's cousin, once removed<sup>97</sup>) was born in April 1973, in Bolton, Lancashire, England, to Roy Wardle<sup>49</sup> and Margaret Jameson<sup>48</sup>, as shown in family tree 15.
25. JACQUELINE A THORNES (Andrew's cousin's wife, once removed<sup>158</sup>).  
Jacqueline married Timothy James Wardle<sup>24</sup>.  
Jacqueline gave birth to one daughter:  
Ms. Thornes  
*This family is shown as family tree 5.*  
Timothy James Wardle<sup>34</sup>, aged about 31, married Jacqueline A Thornes in 2004 in Isle of Wight, Isle of Wight, United Kingdom. They had two daughters:  
Ms. Wardle<sup>1</sup>  
Ms. Wardle<sup>2</sup>  
*This family is shown as family tree 5.*
26. JAMES RICHARD SOMERSALL (Andrew's cousin, once removed<sup>100</sup>) was born in July 1978, in N E Hants, Oxfordshire, Isle of Wight, Hampshire, Berkshire, to Mel Somersall<sup>51</sup> and Susan D Jameson<sup>50</sup>, as shown in family tree 16.
27. PAULA ELIZABETH ANDERSON (Andrew's cousin's wife, once removed<sup>159</sup>) was born in April 1976, in Durham Northern, Durham. '2003–2010' she resided in Durham, Durham, England, United Kingdom. '2011–2018' she resided in Durham, County Durham, England.  
James Richard Somersall<sup>26</sup>, aged about 23, married Paula Elizabeth Anderson, aged about 26, in 2002 in Durham Northern, Durham, United Kingdom. They had three sons:  
Mr. Somersall<sup>3</sup>  
Nathan James Somersall<sup>4</sup> in 1997  
Tristan Thomas Somersall<sup>5</sup> in 2003  
*This family is shown as family tree 6.*
28. JASON ANDREW O'MARA (Andrew's cousin, once removed<sup>112</sup>) was born in October 1970, in Wandsworth, London, to Paul Thomas O'Mara<sup>55</sup> and Edwina M Jablonski<sup>54</sup>, as shown in family tree 18.
29. CRAIG ANTONY O'MARA (Andrew's cousin, once removed<sup>110</sup>) was born in October 1973, in Wandsworth, London, to Paul Thomas O'Mara<sup>55</sup> and Edwina M Jablonski<sup>54</sup>, as shown in family tree 18.
30. SCOTT MCLAREN (Andrew's cousin, once removed<sup>111</sup>) was born in April 1978, in Surrey South Western, Surrey, to Neil McLaren<sup>57</sup> and Janina M A Jablonski<sup>56</sup>, as shown in family tree 19.
31. AMY MCLAREN (Andrew's cousin, once removed<sup>113</sup>) was born in January 1980, in Surrey South Western, Surrey, to Neil McLaren<sup>57</sup> and Janina M A Jablonski<sup>56</sup>, as shown in family tree 19.

32. PAULINE ANNE JABLONSKI (Andrew's cousin, once removed<sup>107</sup>) was born in July 1978, in Derby, Derbyshire, to Andrew P Jablonski<sup>60</sup> and Anne J Crawley<sup>61</sup>, as shown in family tree 21.
33. SIMON ANDREW JABLONSKI (Andrew's cousin, once removed<sup>105</sup>) was born in October 1979, in Derby, Derbyshire, to Andrew P Jablonski<sup>60</sup> and Anne J Crawley<sup>61</sup>, as shown in family tree 21.
34. TIMOTHY JOHN JABLONSKI (Andrew's cousin, once removed<sup>106</sup>) was born in January 1982, in Derby, Derbyshire, to Andrew P Jablonski<sup>60</sup> and Anne J Crawley<sup>61</sup>, as shown in family tree 21.
35. ROBERT ANTHONY JABLONSKI (Andrew's cousin, once removed<sup>104</sup>) was born in June 1985, in Derby, Derbyshire, to Andrew P Jablonski<sup>60</sup> and Anne J Crawley<sup>61</sup>, as shown in family tree 21.
36. MARTIN BROWN (Andrew's second cousin, once removed<sup>238</sup>) was born on 21 January 1993 to Ian J Brown<sup>76</sup> and Judith Harwood<sup>75</sup>, as shown in family tree 25.
37. XIMENG LUCY FAN (Andrew's second cousin's wife, once removed<sup>262</sup>) was born in Kunming, Kuenming Shiqu, Yunnan, China.  
Martin Brown<sup>36</sup> married Ximeng Lucy Fan. See family tree 7.
38. CHRISTOPHER BROWN (Andrew's second cousin, once removed<sup>237</sup>) was born on 19 September 1995 to Ian J Brown<sup>76</sup> and Judith Harwood<sup>75</sup>, as shown in family tree 25.
39. MEGAN STOBBE (Andrew's second cousin's wife, once removed<sup>261</sup>).  
Christopher Brown<sup>38</sup> married Megan Stobbe. See family tree 8.

### Generation of Peers

40. ANDREW JOHN JAMESON (The subject of this report) was born on 5 April 1952, in Havercroft, Bolton, Lancashire, England, to Robert Bryan Jameson<sup>79</sup> and Mary Atkinson Roocroft<sup>80</sup>, as shown in family tree 27. In September 1975, aged 23, he resided in Stornoway, Scotland. In January 1977, aged 24, he resided in Black Isle, Scotland. In September 1985, aged 33, he resided in Appleshaw, Hampshire, England. In January 1991, aged 38, Andrew resided in Dean Village, Edinburgh. In June 1995, aged 43, he resided in North Berwick, East Lothian, Scotland. In September 1999, aged 47, he resided in Chorlton cum Hardy, Lancashire, England. In August 2003, aged 51, Andrew resided in Astley village, Chorley, Lancashire, England. In 2014, aged about 62, he resided in Pechón, Spain. On 21 October 2021, aged 69, he resided in Alyth, Perthshire, Scotland.
- The following information is also recorded for Andrew. Address in 2009, aged about 57, in Pechón, Spain. Andrew married three times. He was married to Judith Anne Whitehurst<sup>41</sup>, Jane Elizabeth Woods<sup>42</sup> and Sally Emerson<sup>43</sup>.
41. JUDITH ANNE WHITEHURST (Andrew's wife<sup>7</sup>) was born in May 1954, in Stoke, Staffordshire, to Frank Whitehurst and Margaret Bickley. In 1985, aged about 31, she resided in Andover, Hampshire, England.
- Andrew John Jameson<sup>40</sup>, aged 25, married Judith Anne Whitehurst, aged 23, in December 1977 in Bolton, Lancashire, England, and they were divorced in 1989, when aged 37 and 35 respectively. They had two sons:  
John Ross Jameson<sup>6</sup> in 1981  
Robert Cameron Jameson<sup>7</sup> in 1987  
*This family is shown as family tree 9.*

42. JANE ELIZABETH WOODS (Andrew's wife<sup>6</sup>) was born on 25 May 1957, in Preston, Lancashire, England, to Peter Anthony Woods and Beatrix Marian Hulton. '2004–2010' she resided in Chorley, Lancashire, England, United Kingdom. She died on 27 September 2024, aged 67, in Alyth, Perthshire, Scotland. The following information is also recorded for Jane. Address in 2009, aged about 52, in Pechón, Cantabria, Spain; Hoshika - Our Shiba Inu (D.O.B. : 12 September 2014 Breeder : Jaquelin / Raquel Rodríguez, Amatsu Kami, Cartagena, Murcia, Spain) on 12 September 2014, aged 57, in Pechón, Cantabria, Spain.



Jane married twice. She was married to Martin Craig Watts and Andrew John Jameson<sup>40</sup>.

Martin Craig Watts, aged 22, married Jane Elizabeth Woods, aged 22, in August 1979 in Preston and Ribble, Lancashire, United Kingdom. They divorced in 1993, when aged 36 and 36 respectively, in Chorley, Lancashire, England. They had one daughter:

Rachel Jane Watts<sup>8</sup> in 1990

Andrew John Jameson<sup>40</sup>, aged 66, married Jane Elizabeth Woods, aged 60, on 19 May 2018 in Contin, Ross-shire, Scotland. They had one daughter:

Rachel Jane Watts<sup>8</sup> in 1990

*This family is shown as family tree 10.*

43. SALLY EMERSON (Andrew's wife<sup>5</sup>) was born on 21 July 1953, in Newcastle upon Tyne, Northumberland. Andrew John Jameson<sup>40</sup> married Sally Emerson. They had one daughter:



Catherine Jane Emerson<sup>10</sup> in 1992

The following information is also recorded for this family. Separation in 1995, when Andrew was aged 43 and Sally was aged 41.

This family is shown as family tree 11.

44. LINDA JANE JAMESON (Andrew's sister<sup>3</sup>) was born on 20 September 1954, in Bolton, Lancashire, England, to Robert Bryan Jameson<sup>79</sup> and Mary Atkinson Roorcroft<sup>80</sup>, as shown in family tree 27.



45. CÉSAR CAMBLOR (Andrew's brother-in-law<sup>23</sup>).



César Camblor married Linda Jane Jameson<sup>44</sup>. They had five children:

Roberto Camblor Jameson<sup>12</sup> in 1986

Nicholas Camblor Jameson<sup>13</sup> in 1988

Mateo Camblor Jameson<sup>14</sup> in 1991

Sofía Camblor Jameson<sup>15</sup> in 1993

Linda Camblor Jameson<sup>16</sup> in 1995

This family is shown as family tree 13.

46. KATHRYN MARY JAMESON (Andrew's sister<sup>4</sup>) was born on 8 August 1957, in Bolton, Lancashire, England, to Robert Bryan Jameson<sup>79</sup> and Mary Atkinson Roorcroft<sup>80</sup>, as shown in family tree 27.



Kathryn married William Leslie Vickers<sup>47</sup>.

Kathryn Mary Jameson was married in April 1981 in Bolton, Lancashire, England.

47. WILLIAM LESLIE VICKERS (Andrew's brother-in-law<sup>22</sup>).



William Leslie Vickers married Kathryn Mary Jameson<sup>46</sup>. They had three children:

Linda Charlotte Vickers<sup>17</sup> in 1985

Thomas William Vickers<sup>19</sup> in 1987

Benjamin James Vickers<sup>20</sup> in 1989

This family is shown as family tree 14.

48. MARGARET JAMESON (Andrew's cousin<sup>52</sup>) was born on 14 October 1940, in Farnworth, Lancashire, to John Corris Jameson<sup>81</sup> and Sarah Gardiner<sup>82</sup>, as shown in family tree 28. She died on 11 April 2019, aged 78, in Bolton, Lancashire, England.



49. ROY WARDLE (Andrew's cousin's husband<sup>94</sup>) was born on 11 February 1941, in Bolton, Lancashire, England.



He died on 8 December 2012, aged 71, in Bolton, Lancashire, England.

Roy Wardle, aged 25, married Margaret Jameson<sup>48</sup>, aged 25, on 20 July 1966 in Bolton, Lancashire, England. They had three sons:

Robin Marcus Wardle<sup>21</sup> in 1969

Edward Jonathan Wardle<sup>23</sup> in 1971

Timothy James Wardle<sup>24</sup> in 1973

*This family is shown as family tree 15.*

50. SUSAN D JAMESON (Andrew's cousin<sup>50</sup>) was born in January 1947, in Farnworth, Lancashire, to John Corris Jameson<sup>81</sup> and Sarah Gardiner<sup>82</sup>, as shown in family tree 28.

51. MEL SOMERSALL (Andrew's cousin's husband<sup>96</sup>).

Mel Somersall married Susan D Jameson<sup>50</sup>. They had one son:

James Richard Somersall<sup>26</sup> in 1978

*This family is shown as family tree 16.*

52. JOHN E JABLONSKI (Andrew's cousin<sup>57</sup>) was born to Janik Jablonski<sup>85</sup> and Brenda Jameson<sup>84</sup>, as shown in family tree 29.



53. CATHERINE R WARMINGTON (Andrew's cousin's wife<sup>101</sup>) was born in April 1948, in Wells, Somerset.

John E Jablonski<sup>52</sup> married Catherine R Warmington, aged 24, in January 1973 in Andover, Hampshire, United Kingdom. See family tree 17.



54. EDWINA M JABLONSKI (Andrew's cousin<sup>60</sup>) was born in July 1948, in Bolton, Lancashire, England, to Janik Jablonski<sup>85</sup> and Brenda Jameson<sup>84</sup>, as shown in family tree 29.



55. PAUL THOMAS O'MARA (Andrew's cousin's husband<sup>109</sup>) was born in 1939. Paul resided in Twickenham, Middlesex, England. He died on 30 December 2010, aged about 71.

Paul Thomas O'Mara, aged about 30, married Edwina M Jablonski<sup>54</sup>, aged 21, in July 1969 in Chatham, Kent, United Kingdom. They had two sons:

Jason Andrew O'Mara<sup>28</sup> in 1970

Craig Antony O'Mara<sup>29</sup> in 1973

*This family is shown as family tree 18.*

56. JANINA M A JABLONSKI (Andrew's cousin<sup>61</sup>) was born in October 1949, in Uxbridge, Middlesex, to Janik Jablonski<sup>85</sup> and Brenda Jameson<sup>84</sup>, as shown in family tree 29.



57. NEIL MCLAREN (Andrew's cousin's husband<sup>108</sup>).

Neil McLaren married Janina M A Jablonski<sup>56</sup>, aged 23, in April 1973 in Maidstone, Kent, United Kingdom. They had two children:

Scott McLaren<sup>30</sup> in 1978

Amy McLaren<sup>31</sup> in 1980

*This family is shown as family tree 19.*



58. DENNIS C JABLONSKI (Andrew's cousin<sup>59</sup>) was born in July 1952, in Uxbridge, Middlesex, to Janik Jablonski<sup>85</sup> and Brenda Jameson<sup>84</sup>, as shown in family tree 29.



59. LAURA E SLATER (Andrew's cousin's wife<sup>103</sup>).

Dennis C Jablonski<sup>58</sup>, aged 31, married Laura E Slater in July 1983 in Chatham, Kent, United Kingdom. See family tree 20.



60. ANDREW P JABLONSKI (Andrew's cousin<sup>58</sup>) was born in October 1954, in Lewisham, Greater London, to Janik Jablonski<sup>85</sup> and Brenda Jameson<sup>84</sup>, as shown in family tree 29. '2003–2007' he resided in Derby, Derbyshire, England, United Kingdom.



61. ANNE J CRAWLEY (Andrew's cousin's wife<sup>102</sup>).

Andrew P Jablonski<sup>60</sup>, aged 21, married Anne J Crawley in July 1976 in High Peak, Derbyshire, United Kingdom. They had four children:

Pauline Anne Jablonski<sup>32</sup> in 1978

Simon Andrew Jablonski<sup>33</sup> in 1979

Timothy John Jablonski<sup>34</sup> in 1982

Robert Anthony Jablonski<sup>35</sup> in 1985

This family is shown as family tree 21.



62. SHEILA ANNE JAMESON (Andrew's cousin<sup>55</sup>) was born in October 1954, in Farnworth, Lancashire, to Donald Templeman Jameson<sup>87</sup> and Sheila Sanderson<sup>88</sup>, as shown in family tree 30.



63. PHILIP BOOTH (Andrew's cousin's husband<sup>95</sup>).

Philip Booth married Sheila Anne Jameson<sup>62</sup>, aged 25, in April 1980 in Blackpool & Fylde, Lancashire, United Kingdom. See family tree 22.



64. RICHARD D JAMESON (Andrew's cousin<sup>49</sup>) was born in January 1956, in Bolton, Lancashire, England, to Donald Templeman Jameson<sup>87</sup> and Sheila Sanderson<sup>88</sup>, as shown in family tree 30.



65. PETER M JAMESON (Andrew's cousin<sup>48</sup>) was born in April 1957, in Bolton, Lancashire, England, to Donald Templeman Jameson<sup>87</sup> and Sheila Sanderson<sup>88</sup>, as shown in family tree 30.



66. JEAN S JAMESON (Andrew's cousin<sup>53</sup>) was born in October 1959, in Bolton, Lancashire, England, to Donald Templeman Jameson<sup>87</sup> and Sheila Sanderson<sup>88</sup>, as shown in family tree 30.



67. ELIZABETH H JAMESON (Andrew's cousin<sup>54</sup>) was born in January 1964, in Farnworth, Lancashire, to Donald Templeman Jameson<sup>87</sup> and Sheila Sanderson<sup>88</sup>, as shown in family tree 30.



68. ANGELA RUTH JAMESON (Andrew's cousin<sup>51</sup>) was born in October 1968, in Farnworth, Lancashire, to Donald Templeman Jameson<sup>87</sup> and Sheila Sanderson<sup>88</sup>, as shown in family tree 30.



69. DAVID A B POTTS (Andrew's cousin's husband<sup>93</sup>).  
David A B Potts married Angela Ruth Jameson<sup>68</sup>, aged about 31, in 2000 in Whitehaven, Cumbria, United Kingdom. See family tree 23.

70. IAN ROBERT JAMESON (Andrew's cousin<sup>47</sup>) was born in July 1970, in Blackpool, Lancashire, to Donald Templeman Jameson<sup>87</sup> and Sheila Sanderson<sup>88</sup>, as shown in family tree 30.



71. DAVID J ROOCROFT (Andrew's cousin<sup>73</sup>) was born on 26 August 1958, in Farnworth, Lancashire, to John Marsden Roocroft<sup>89</sup> and Joan Haddock<sup>90</sup>, as shown in family tree 31. David resided in Bolton, Lancashire, England. He died on 25 August 2017, aged 58.

72. CAROLINE ROOCROFT (Andrew's cousin<sup>74</sup>) was born on 2 April 1963 to John Marsden Roocroft<sup>89</sup> and Joan Haddock<sup>90</sup>, as shown in family tree 31.

73. CAROLYN ANNE HARWOOD (Andrew's second cousin<sup>194</sup>) was born in April 1962, in Prescot, Lancashire, to Leslie James Harwood<sup>94</sup> and Margaret Linda Wood<sup>93</sup>, as shown in family tree 32.

74. STEPHEN BAILEY (Andrew's second cousin's husband<sup>235</sup>) was born on 11 August 1955.  
Stephen Bailey, aged about 38, married Carolyn Anne Harwood<sup>73</sup>, aged about 32, in 1994 in Warrington, Cheshire, United Kingdom. See family tree 24.

75. JUDITH HARWOOD (Andrew's second cousin<sup>193</sup>) was born in January 1964, in Prescot, Lancashire, to Leslie James Harwood<sup>94</sup> and Margaret Linda Wood<sup>93</sup>, as shown in family tree 32.

76. IAN J BROWN (Andrew's second cousin's husband<sup>236</sup>) was born on 11 November 1959.  
Ian J Brown, aged about 29, married Judith Harwood<sup>75</sup>, aged about 25, in 1989 in St. Helens, Merseyside, United Kingdom. They had two sons:  
Martin Brown<sup>36</sup> in 1993  
Christopher Brown<sup>38</sup> in 1995  
*This family is shown as family tree 25.*

77. SIMON A ROOCROFT (Andrew's third cousin<sup>249</sup>) was born in October 1961, in Bolton, Lancashire, England, to David Ewart Roocroft<sup>97</sup> and Irene Elizabeth McDonald Brock<sup>98</sup>, as shown in family tree 34. '2003–2004' he resided in Bolton, Lancashire, England.

78. BEVERLEY J THORNLEY (Andrew's third cousin's wife<sup>265</sup>) was born in April 1958, in Bolton, Lancashire, England.  
Simon A Roocroft<sup>77</sup>, aged about 25, married Beverley J Thornley, aged about 29, in 1987 in Bolton, Lancashire, England. See family tree 26.

### Generation of Parents

79. ROBERT BRYAN JAMESON (Andrew's father<sup>1</sup>, see Paternal Ancestry) was born in December 1926, in Bolton, Lancashire, England, to Edward Corris Jameson<sup>99</sup> and Emma Templeman<sup>100</sup>, as shown in family tree 35. '2003–2004' he resided in Bolton, Lancashire, England. He resided in Bolton, Lancashire, England. He died on 16 April 2012, aged 85, in Bolton, Lancashire, England.



80. MARY ATKINSON ROOCROFT (Andrew's mother<sup>2</sup>, see Maternal Ancestry) was born on 8 September 1928 to James Roocroft<sup>101</sup> and Dora Marsden Atkinson<sup>102</sup>, as shown in family tree 36.  
Robert Bryan Jameson<sup>79</sup>, aged 24, married Mary Atkinson Roocroft, aged 22, in January 1951 in Bolton, Lancashire, England. They had three children:  
Andrew John Jameson<sup>40</sup> in 1952  
Linda Jane Jameson<sup>44</sup> in 1954  
Kathryn Mary Jameson<sup>46</sup> in 1957



This family is shown as family tree 27.

81. JOHN CORRIS JAMESON (Andrew's uncle<sup>14</sup>) was born on 19 March 1914, in Bolton, Lancashire, England, to Edward Corris Jameson<sup>99</sup> and Emma Templeman<sup>100</sup>, as shown in family tree 35. In 1921, aged about 7, he resided in Bolton, Lancashire, England (Relation to Head of House: Son). In 1939, aged about 25, he resided in Lancashire, England (Marital Status: Single; Occupation: Crocers & Provision Dealer). He died on 4 November 1976, aged 62, in Withington Hospital, Manchester. John was buried on 10 November 1976 in Lancashire, England.



82. SARAH GARDINER (Andrew's aunt by marriage<sup>45</sup>) was born on 14 September 1914, in Craghead, Co.Durham. She died on 26 April 1996, aged 81, in Durham, Co.Durham.  
John Corris Jameson<sup>81</sup>, aged 25, married Sarah Gardiner, aged 25, on 31 December 1939 in Craghead, Durham, England. They had two daughters:  
Margaret Jameson<sup>48</sup> in 1940  
Susan D Jameson<sup>50</sup> in 1947



This family is shown as family tree 28.

83. EDWARD DENNIS JAMESON (Andrew's uncle<sup>15</sup>) was born on 1 March 1920, in Bolton, Lancashire, England, to Edward Corris Jameson<sup>99</sup> and Emma Templeman<sup>100</sup>, as shown in family tree 35. In 1921, aged about 1, he resided in Bolton, Lancashire, England (Relation to Head of House: Son). In 1939, aged about 19, he resided in Lancashire, England (Marital Status: Single; Occupation: Library Assistant). He died on 27 July 1944, aged 24, in Bolton, Lancashire, England.  
The following information is also recorded for Edward. Probate: on 16 November 1944, in Llandudno.



84. BRENDA JAMESON (Andrew's aunt<sup>18</sup>) was born on 8 October 1921, in Bolton, Lancashire, England, to Edward Corris Jameson<sup>99</sup> and Emma Templeman<sup>100</sup>, as shown in family tree 35. She died on 21 March 2014, aged 92, in Canterbury, Kent, England.



85. JANIK JABLONSKI (Andrew's uncle by marriage<sup>56</sup>) was born on 24 October 1912, in Vilna Poland. He died on 19 April 1985, aged 72, in Chatham, Kent, England.



Janik Jablonski, aged 32, married Brenda Jameson<sup>84</sup>, aged 23, on 24 October 1944 in Westminster, Middlesex, United Kingdom. They had five children:

John E Jablonski<sup>52</sup>  
Edwina M Jablonski<sup>54</sup> in 1948  
Janina M A Jablonski<sup>56</sup> in 1949

Dennis C Jablonski<sup>58</sup> in 1952  
Andrew P Jablonski<sup>60</sup> in 1954

This family is shown as family tree 29.

86. KATHLEEN NINA JAMESON (Andrew's aunt<sup>17</sup>) was born on 14 July 1923, in Bolton, Lancashire, England, to Edward Corris Jameson<sup>99</sup> and Emma Templeman<sup>100</sup>, as shown in family tree 35. In 1939, aged about 15, she resided in Lancashire, England (Marital Status: Single; Occupation: Mill Office shorthand Typist). She resided in Bolton, Lancashire, England. She died on 10 January 2001, aged 77, in Bolton, Lancashire, England.



87. DONALD TEMPLEMAN JAMESON (Andrew's uncle<sup>16</sup>) was born on 29 December 1924, in Bolton, Lancashire, England, to Edward Corris Jameson<sup>99</sup> and Emma Templeman<sup>100</sup>, as shown in family tree 35. In 1939, aged about 14, he resided in Lancashire, England (Marital Status: Single; Occupation: Iron Steel-Apperntice Fitter). He resided in Thornton-Cleveleys, Lancashire, England. He died on 23 September 2005, aged 80, in Thornton Cleveleys, Lancashire, England.



88. SHEILA SANDERSON (Andrew's aunt by marriage<sup>46</sup>) was born on 16 July 1930, in Nelson, Lancashire, England. '2004–2006' she resided in Thornton-Cleveleys, Lancashire, England, United Kingdom. In 2014, aged about 83, she resided in York, North Yorkshire, England. She resided in York, North Yorkshire, England. Sheila died on 20 July 2016, aged 86, in York, Yorkshire, England.



Donald Templeman Jameson<sup>87</sup>, aged 28, married Sheila Sanderson, aged 23, on 12 August 1953 in Bolton, Lancashire, England. They had seven children:

Sheila Anne Jameson<sup>62</sup> in 1954

Richard D Jameson<sup>64</sup> in 1956

Peter M Jameson<sup>65</sup> in 1957

Jean S Jameson<sup>66</sup> in 1959

Elizabeth H Jameson<sup>67</sup> in 1964

Angela Ruth Jameson<sup>68</sup> in 1968

Ian Robert Jameson<sup>70</sup> in 1970

*This family is shown as family tree 30.*

89. JOHN MARSDEN ROOCROFT (Andrew's uncle<sup>21</sup>) was born in July 1931, in Bolton, Lancashire, England, to James Roorcroft<sup>101</sup> and Dora Marsden Atkinson<sup>102</sup>, as shown in family tree 36. John resided in Bognor Regis, West Sussex, England. He died on 16 December 2010, aged 79.



90. JOAN HADDOCK (Andrew's aunt by marriage<sup>72</sup>) was born in July 1937, in Bolton, Lancashire, England, to Jack Haddock and Florence Flitcroft.



John Marsden Roorcroft<sup>89</sup>, aged 27, married Joan Haddock, aged 21, in July 1958 in Bolton, Lancashire, England. They had two children:

David J Roorcroft<sup>71</sup> in 1958

Caroline Roorcroft<sup>72</sup> in 1963

This family is shown as family tree 31.

91. AUDREY TEMPLEMAN (Andrew's cousin, once removed<sup>92</sup>) was born in April 1921, in Bourne, Lincolnshire, to Edith Templeman<sup>112</sup>, as shown in family tree 40. She is no longer living.



92. MURIEL IRENE JONES (Andrew's cousin, once removed<sup>121</sup>) was born on 5 September 1917, in Bolton, Lancashire, England, to Charles Watkin Jones<sup>115</sup> and Alice Roorcroft<sup>114</sup>, as shown in family tree 41. She was baptised (LDS) on 9 December 1917, in Bolton, Lancashire, England. In 1921, aged about 3, she resided in Bolton, Lancashire, England (Relation to Head of House: Daughter). She is no longer living.

93. MARGARET LINDA WOOD (Andrew's cousin, once removed<sup>138</sup>) was born on 13 June 1924, in Bolton, Lancashire, England, to Ernest Croft Wood<sup>121</sup> and Linda Marsden Atkinson<sup>120</sup>, as shown in family tree 43. She died in 2011, aged about 87, in Warrington, Lancashire, England.



94. LESLIE JAMES HARWOOD (Andrew's cousin's husband, once removed<sup>192</sup>) was born on 31 August 1924, in St Helens, Lancashire, England. He died in 2006, aged about 81, in Warrington, Cheshire, England.



Leslie James Harwood, aged 31, married Margaret Linda Wood<sup>93</sup>, aged 32, in July 1956 in Bolton, Lancashire, England. They had two daughters:

Carolyn Anne Harwood<sup>73</sup> in 1962  
Judith Harwood<sup>75</sup> in 1964

This family is shown as family tree 32.

95. JOHN DEREK WOOD (Andrew's cousin, once removed<sup>137</sup>) was born on 13 July 1926, in Bolton, Lancashire, England, to Ernest Croft Wood<sup>121</sup> and Linda Marsden Atkinson<sup>120</sup>, as shown in family tree 43. He died in 2020, aged about 93.



96. BARBARA E BIBBY (Andrew's cousin's wife, once removed<sup>191</sup>) was born in 1927. She died in 2019, aged about 92.



John Derek Wood<sup>95</sup>, aged 26, married Barbara E Bibby, aged about 25, in January 1953 in Bolton, Lancashire, England. See family tree 33.

97. DAVID EWART ROOCROFT (Andrew's second cousin, once removed<sup>224</sup>) was born on 19 July 1936, in Bolton, Lancashire, England, to Eric Talbot Roocroft<sup>122</sup> and Aileen Mary King<sup>123</sup>, as shown in family tree 44. In 1984, aged about 47, he resided in Bolton, Lancashire, England.



98. IRENE ELIZABETH MCDONALD BROCK (Andrew's second cousin's wife, once removed<sup>248</sup>) was born in 1937, in Bolton, Lancashire, England. She died on 21 December 2019, aged about 82.

David Ewart Roocroft<sup>97</sup>, aged 23, married Irene Elizabeth McDonald Brock, aged about 22, on 8 June 1960 in Bolton, Lancashire, England. They had one son:

Simon A Roocroft<sup>77</sup> in 1961

This family is shown as family tree 34.

### Generation of Grandparents

99. EDWARD CORRIS JAMESON (Andrew's grandfather<sup>12</sup>, see Paternal Ancestry) was born on 30 April 1880, in Wigan, Lancashire, England, to John Jameson<sup>133</sup> and Mary Elizabeth Corris<sup>134</sup>, as shown in family tree 49. In 1921, aged about 41, he resided in Bolton, Lancashire, England (Occupation: Grocers Branch Manager; Marital Status: Married; Relation to Head of House: Head). He died on 13 April 1951, aged 70, in Bolton, Lancashire, England.



Edward married Emma Templeman<sup>100</sup>.

Edward Corris Jameson was married in April 1913 in Bolton, Lancashire, England.

100. EMMA TEMPLEMAN (Andrew's grandmother<sup>13</sup>, see Paternal Ancestry) was born on 26 May 1888, in Carlby, Lincoln, to Thomas Templeman<sup>135</sup> and Jane Cobb<sup>136</sup>, as shown in family tree 50. In 1891, aged about 3, she resided in Carlby, Carlby, Carlby, Lincolnshire, England (Relation to Head of House: Granddaughter). In 1901, aged about 13, she resided in Carlby, Carlby, Lincolnshire, England (Relation to Head of House: Daughter). In 1921, aged about 33, she resided in Bolton, Lancashire, England (Marital Status: Married; Relation to Head of House: Wife). Emma died on 25 December 1966, aged 78, in Bolton, Lancashire, England.



Edward Corris Jameson<sup>99</sup>, aged 33, married Emma Templeman, aged 25, on 25 June 1913 in Bolton, Lancashire, England. They had six children:

John Corris Jameson<sup>81</sup> in 1914

Edward Dennis Jameson<sup>83</sup> in 1920

Brenda Jameson<sup>84</sup> in 1921



Kathleen Nina Jameson<sup>86</sup> in 1923

Donald Templeman Jameson<sup>87</sup> in 1924

Robert Bryan Jameson<sup>79</sup> in 1926

This family is shown as family tree 35.

101. JAMES ROOCROFT (Andrew's grandfather<sup>19</sup>, see Maternal Ancestry) was born on 8 October 1897, in Bolton, Lancashire, England, to Robert Roocroft<sup>137</sup> and Elizabeth Evelyne Best<sup>138</sup>, as shown in family tree 51. In 1915, aged about 17, he resided in 139 Mere Hall St, Bolton. He died on 22 February 1984, aged 86, in Bolton, Lancashire, England. He was buried on 28 February 1984 in Lancashire, England. The following information is also recorded for James. Probate: on 30 April 1984, in Manchester, Lancashire, England.
- 
102. DORA MARSDEN ATKINSON (Andrew's grandmother<sup>20</sup>, see Maternal Ancestry) was born on 16 December 1899, in Bolton, Lancashire, England, to John Atkinson<sup>139</sup> and Mary Ellen Marsden<sup>140</sup>, as shown in family tree 52. She died on 24 December 1981, aged 82, in Bolton, Lancashire, England. She was buried on 31 December 1981 in Lancashire, England.
- 
- James Roocroft<sup>101</sup>, aged 29, married Dora Marsden Atkinson, aged 27, on 5 October 1927 in Bolton, Lancashire, England. They had two children:  
 Mary Atkinson Roocroft<sup>80</sup> in 1928  
 John Marsden Roocroft<sup>89</sup> in 1931  
*This family is shown as family tree 36.*
103. WILLIAM CORRIS JAMESON (Andrew's great-uncle<sup>36</sup>) was born in December 1878, in Rock Ferry, Cheshire, England, to John Jameson<sup>133</sup> and Mary Elizabeth Corris<sup>134</sup>, as shown in family tree 49. He died on 4 January 1939, aged 60, in 21 Astbury Avenue Audenshaw Lancashire.
104. JANE CORRIS JAMESON (Andrew's great-aunt<sup>39</sup>) was born in June 1882, in Wigan, Lancashire, England, to John Jameson<sup>133</sup> and Mary Elizabeth Corris<sup>134</sup>, as shown in family tree 49. She died in September 1886, aged 4, in Lancashire, United Kingdom.
105. AMELIA ANN JAMESON (Andrew's great-aunt<sup>38</sup>) was born on 24 November 1884, in Patricroft, Lancashire, England, to John Jameson<sup>133</sup> and Mary Elizabeth Corris<sup>134</sup>, as shown in family tree 49. In 1939, aged about 54, she resided in Lancashire, England (Marital Status: Married; Occupation: Unpaid Domestic Duties). She died on 14 July 1953, aged 68. She was buried on 17 July 1953 in Lancashire, England. Amelia married George O A Sellen<sup>106</sup>.  
 Amelia Ann Jameson was married in April 1910 in Bolton, Lancashire, United Kingdom.
106. GEORGE O A SELLEN (Andrew's great-uncle by marriage<sup>83</sup>) was born on 27 May 1883. In 1939, aged about 56, he resided in Lancashire, England (Marital Status: Married; Occupation: Locomotive Fitter). He is no longer living.  
 George O A Sellen married Amelia Ann Jameson<sup>105</sup>. See family tree 37.
107. JOHN JAMESON (Andrew's great-uncle<sup>37</sup>) was born about 1891, in Horwich, Lancashire, England, to John Jameson<sup>133</sup> and Mary Elizabeth Corris<sup>134</sup>, as shown in family tree 49. He died in July 1958, aged about 67, in Fylde, Lancashire, England.
108. AMOS STIMSON TEMPLEMAN (Andrew's great-uncle<sup>42</sup>) was born in 1879, in Carlby, Lincoln, to Thomas Templeman<sup>135</sup> and Jane Cobb<sup>136</sup>, as shown in family tree 50. He died in 1968, aged about 89. Amos married Katherine Sargeant<sup>109</sup>.  
 Amos Stimson Templeman was married in April 1901 in Stamford, Lincolnshire, United Kingdom.
109. KATHERINE SARGEANT (Andrew's great-aunt by marriage<sup>90</sup>) was born in 1879, in Pickworth Rutland. She is no longer living.  
 Amos Stimson Templeman<sup>108</sup>, aged about 23, married Katherine Sargeant, aged about 23, in 1902. See family tree 38.
110. LOUISA (KATE) CATHERINE TEMPLEMAN (Andrew's great-aunt<sup>43</sup>) was born on 17 March 1881, in Carlby, Lincolnshire, England, to Thomas Templeman<sup>135</sup> and Jane Cobb<sup>136</sup>, as shown in family tree 50. In 1891, aged about 10, she resided in Carlby, Carlby, Carlby, Lincolnshire, England (Relation to Head of House: Granddaughter). In 1911, aged about 30, she resided in Manthorpe and Carlby, Lincolnshire, England (Marital Status: Single; Relation to Head of House: Daughter; Occupation: Housekeeper). She died in April 1972, aged 91, in Stafford, Staffordshire, England. The following information is also recorded for Louisa. AKA (Auntie Kate).
- 

111. ALBERT GEORGE WAKEFIELD (Andrew's great-uncle by marriage<sup>91</sup>) was born on 12 March 1884, in Stamford, Lincolnshire, United Kingdom. He died in June 1950, aged 66, in Stamford, Lincolnshire, England.
- 
- Albert George Wakefield, aged 32, married Louisa (Kate) Catherine Templeman<sup>110</sup>, aged 35, in October 1916 in Bourne, Lincolnshire, United Kingdom. See family tree 39.
112. EDITH TEMPLEMAN (Andrew's great-aunt<sup>44</sup>) was born about 1899, in Carlby, Lincolnshire, England, to Thomas Templeman<sup>135</sup> and Jane Cobb<sup>136</sup>, as shown in family tree 50. In 1901, aged about 2, she resided in Carlby, Carlby, Lincolnshire, England (Relation to Head of House: Daughter). She died in January 1925, aged about 25, in Bourne, Lincolnshire, England.
- Edith gave birth to one daughter:  
Audrey Templeman<sup>97</sup> in 1921  
*This family is shown as family tree 40.*
113. WILLIAM ROOCROFT (Andrew's great-uncle<sup>65</sup>) was born in April 1893, in Bolton, Lancashire, England, to Robert Roorcroft<sup>137</sup> and Elizabeth Evelyne Best<sup>138</sup>, as shown in family tree 51. He died on 25 April 1936, aged 43, in Glossop, Derbyshire, England.
114. ALICE ROOCROFT (Andrew's great-aunt<sup>67</sup>) was born on 21 January 1894, in Bolton, Lancashire, England, to Robert Roorcroft<sup>137</sup> and Elizabeth Evelyne Best<sup>138</sup>, as shown in family tree 51. In 1921, aged about 27, she resided in Bolton, Lancashire, England (Occupation: Milliner; Marital Status: Married; Relation to Head of House: Wife). She died on 12 January 1959, aged 64, in Bolton, Lancashire, England.
- 
- Alice married Charles Watkin Jones<sup>115</sup>.  
Alice Roorcroft was married in October 1913 in Bolton, Lancashire, England.
115. CHARLES WATKIN JONES (Andrew's great-uncle by marriage<sup>120</sup>) was born in 1892, in Horwich, Lancashire, England. In 1921, aged about 29, he resided in Bolton, Lancashire, England (Occupation: Tool, Fitter; Marital Status: Married; Relation to Head of House: Head). He is no longer living.
- Charles married Alice Roorcroft<sup>114</sup>.  
Charles Watkin Jones was married in October 1913 in Bolton, Lancashire, England.  
Charles Watkin Jones married Alice Roorcroft<sup>114</sup>. They had one daughter:  
Muriel Irene Jones<sup>92</sup> in 1917  
*This family is shown as family tree 41.*
116. ETHEL ROOCROFT (Andrew's great-aunt<sup>68</sup>) was born on 17 April 1895, in Bolton, Lancashire, England, to Robert Roorcroft<sup>137</sup> and Elizabeth Evelyne Best<sup>138</sup>, as shown in family tree 51. She died on 2 July 1978, aged 83, in Bolton, Lancashire, England.
117. HERBERT CAMPBELL (Andrew's great-uncle by marriage<sup>119</sup>). He is no longer living.  
Herbert Campbell married Ethel Roorcroft<sup>116</sup>, aged 27, in April 1923 in Bolton, Lancashire, England. See family tree 42.
118. THOMAS HAROLD ROOCROFT (Andrew's great-uncle<sup>64</sup>) was born on 24 June 1898, in Bolton, Lancashire, England, to Robert Roorcroft<sup>137</sup> and Elizabeth Evelyne Best<sup>138</sup>, as shown in family tree 51. He died on 13 August 1955, aged 57, in Vancouver, British Columbia, Canada.
- 
119. EDWARD WALSH ROOCROFT (Andrew's great-uncle<sup>66</sup>) was born on 5 September 1901, in Bolton, Lancashire, England, to Robert Roorcroft<sup>137</sup> and Elizabeth Evelyne Best<sup>138</sup>, as shown in family tree 51. He died on 19 September 1960, aged 59, in Islington Brookfield, London, England.
120. LINDA MARSDEN ATKINSON (Andrew's great-aunt<sup>71</sup>) was born in January 1898, in Bolton, Lancashire, England, to John Atkinson<sup>139</sup> and Mary Ellen Marsden<sup>140</sup>, as shown in family tree 52. She died on 4 April 1951, aged 53, in Prescot, Lancashire.

121. ERNEST CROFT WOOD (Andrew's great-uncle by marriage<sup>136</sup>) was born on 23 August 1897, in Bolton, Lancashire, England, to Joseph Wood and Jane Holden. He died in December 1973, aged 76, in Prescot, Lancashire, England.



Ernest Croft Wood, aged 25, married Linda Marsden Atkinson<sup>120</sup>, aged 25, in July 1923 in Bolton, Lancashire, England. They had two children:  
Margaret Linda Wood<sup>93</sup> in 1924  
John Derek Wood<sup>95</sup> in 1926

This family is shown as family tree 43.

122. ERIC TALBOT ROOCROFT (Andrew's cousin, twice removed<sup>171</sup>) was born on 18 August 1908, in Bolton, Lancashire, England, to William Roocroft<sup>146</sup> and Clara Talbot<sup>147</sup>, as shown in family tree 53. In 1940, aged about 31, he resided in Lancashire, England, United Kingdom. He died on 28 May 1987, aged 78, in Bolton, Lancashire, England.

123. AILEEN MARY KING (Andrew's cousin's wife, twice removed<sup>223</sup>) was born on 10 January 1906, in Nottingham, Nottinghamshire, England. She died on 7 February 1989, aged 83, in Lancashire, England.

Eric Talbot Roocroft<sup>122</sup>, aged 26, married Aileen Mary King, aged 29, in April 1935 in Bolton, Lancashire, England. They had one son:

David Ewart Roocroft<sup>97</sup> in 1936

This family is shown as family tree 44.

124. CISSIE MARSDEN (Andrew's cousin, twice removed<sup>188</sup>) was born on 17 November 1916 to Robert Marsden<sup>155</sup>, as shown in family tree 55. She died on 25 April 1994, aged 77, in Stockport, Greater Manchester, England.



125. BERT WILKINSON (Andrew's cousin's husband, twice removed<sup>232</sup>). He is no longer living.  
Bert Wilkinson married Cissie Marsden<sup>124</sup>. See family tree 45.

126. THOMAS MARSDEN (Andrew's cousin, twice removed<sup>186</sup>) was born on 18 September 1877, in Little Hulton, Bolton, Lancashire, England, to Robert Marsden<sup>155</sup> and Martha Wilkinson<sup>156</sup>, as shown in family tree 54. In 1901, aged about 23, he resided in Bolton, Daubhill, and Rumworth, Bolton, Lancashire, England (Relation to Head of House: Son). He died in 1962, aged about 84.



127. LUCY PENDLEBURY (Andrew's cousin's wife, twice removed<sup>231</sup>) was born on 6 April 1881. She was baptised on 22 May 1881, in Farnworth with Kearsley, St John The Evangelist, Lancashire, England. In 1911, aged about 30, she resided in Bolton, Lancashire, England (Marital Status: Married; Relation to Head of House: Wife). She died in October 1923, aged 42, in Bolton, Lancashire, England.

Thomas Marsden<sup>126</sup>, aged 24, married Lucy Pendlebury, aged 21, in July 1902 in Bolton, Lancashire, United Kingdom. See family tree 46.

128. EDITH MARSDEN (Andrew's cousin, twice removed<sup>187</sup>) was born in 1897, in Daubhill, Bolton, Lancashire, England, to Richard (Dick) Marsden<sup>158</sup> and Amy Ann Woodward<sup>159</sup>, as shown in family tree 56. In 1921, aged about 24, she resided in Kearsley, Lancashire, England (Occupation: Card Room Cotton; Marital Status: Single; Relation to Head of House: Daughter). She died on 13 February 1980, aged about 82, in Bolton, Lancashire.



129. MARY (POLLY) ELIZABETH MARSDEN (Andrew's cousin, twice removed<sup>190</sup>) was born in 1899, in Bolton, Lancashire, England, to Richard (Dick) Marsden<sup>158</sup> and Amy Ann Woodward<sup>159</sup>, as shown in family tree 56. In 1921, aged about 22, she resided in Kearsley, Lancashire, England (Occupation: Weaver Cotton; Marital Status: Single; Relation to Head of House: Daughter). She died on 29 August 1977, aged about 78, in Bolton, Lancashire.



130. JOHN THOMAS LOMAX (Andrew's cousin's husband, twice removed<sup>233</sup>) was born about 1902. He died on 29 July 1973, aged about 71.



John Thomas Lomax, aged about 27, married Mary (Polly) Elizabeth Marsden<sup>129</sup>, aged about 30, on 4 March 1930 in Bolton, Lancashire, England. See family tree 47.

131. ELSIE MARSDEN (Andrew's cousin, twice removed<sup>189</sup>) was born in 1902 to Richard (Dick) Marsden<sup>158</sup> and Amy Ann Woodward<sup>159</sup>, as shown in family tree 56. In 1921, aged about 19, she resided in Kearsley, Lancashire, England (Occupation: Hosery; Marital Status: Single; Relation to Head of House: Daughter). She died on 6 January 1977, aged about 74, in Bolton, Lancashire.



132. ALBERT LORD (Andrew's cousin's husband, twice removed<sup>234</sup>). He died on 10 May 1972 in Bolton, Lancashire.



Albert Lord married Elsie Marsden<sup>131</sup>, aged about 46, in October 1948 in Bolton, Lancashire, England. See family tree 48.

### Generation of Great-Grandparents

133. JOHN JAMESON (Andrew's great-grandfather<sup>34</sup>, see Paternal Ancestry) was born in 1850, in Haigh, Lancashire, England, to William Jameson<sup>161</sup> and Elizabeth Arrowsmith<sup>162</sup>, as shown in family tree 57. He is no longer living.

134. MARY ELIZABETH CORRIS (Andrew's great-grandmother<sup>35</sup>, see Paternal Ancestry) was born in September 1846, in Tranmere, Cheshire, England, to Edward Corris<sup>163</sup> and Jane Harrison<sup>164</sup>, as shown in family tree 58. She died in September 1906, aged 60, in Bolton, Lancashire, England.

John Jameson<sup>133</sup>, aged about 28, married Mary Elizabeth Corris, aged 31, on 31 July 1878 in St Pauls, Tranmere, Cheshire, England. They had five children:

William Corris Jameson<sup>103</sup> in 1878

Edward Corris Jameson<sup>99</sup> in 1880

Jane Corris Jameson<sup>104</sup> in 1882

Amelia Ann Jameson<sup>105</sup> in 1884

John Jameson<sup>107</sup> about 1891

*This family is shown as family tree 49.*

135. THOMAS TEMPLEMAN (Andrew's great-grandfather<sup>40</sup>, see Paternal Ancestry) was born in 1857, in Essendine, Rutland, England, to William Templeman<sup>165</sup> and Ann Allen<sup>166</sup>, as shown in family tree 59. In 1901, aged about 44, he resided in Carlby, Carlby, Lincolnshire, England (Relation to Head of House: Head). In 1911, aged about 54, he resided in Manthorpe and Carlby, Lincolnshire, England (Marital Status: Widowed; Relation to Head of House: Head; Occupation: Masoners Labourer). He died in October 1938, aged about 81, in Bourne, Lincolnshire, England.



Thomas married Jane Cobb<sup>136</sup>.

Thomas Templeman was married in July 1878 in Bourne, Lincolnshire, United Kingdom.

136. JANE COBB (Andrew's great-grandmother<sup>41</sup>, see Paternal Ancestry) was born in 1856, in Coventry, Warwickshire, England, to Amos Cobb<sup>167</sup> and Jane Stimson<sup>168</sup>, as shown in family tree 60. She was baptised on 4 May 1856, in St Thomas', Coventry, Warwick, England. In 1861, aged about 5, she resided in Coventry, St Thomas, Coventry St Michael, Warwickshire, England (Relation to Head of House: Daughter). In 1901, aged about 45, she resided in Carlby, Carlby, Lincolnshire, England (Relation to Head of House: Wife). Jane died in June 1902, aged about 45, in Lincolnshire, United Kingdom.



Thomas Templeman<sup>135</sup> married Jane Cobb. They had four children:



Amos Stimson Templeman<sup>108</sup> in 1879

Louisa (Kate) Catherine Templeman<sup>110</sup> in 1881

Emma Templeman<sup>100</sup> in 1888

Edith Templeman<sup>112</sup> about 1899

*This family is shown as family tree 50.*

137. ROBERT ROOCROFT (Andrew's great-grandfather<sup>62</sup>, see Maternal Ancestry) was born on 1 January 1865, in Bolton, Lancashire, England, to Edward Roocroft<sup>169</sup> and Mary Batty<sup>170</sup>, as shown in family tree 61. In 1915, aged about 50, he resided in Bolton, Lancashire, England (Relation to Head of House: Father). He died in April 1936, aged 71, in Bolton, Lancashire, England.
138. ELIZABETH EVELYNE BEST (Andrew's great-grandmother<sup>63</sup>, see Maternal Ancestry) was born in July 1869, in Bolton, Lancashire, England, to Thomas Walsh Best<sup>171</sup> and Mary Ann Ashburn<sup>172</sup>, as shown within family tree 51. She died in September 1923, aged 54, in Warrington, Lancashire, England.  
Robert Roocroft<sup>137</sup>, aged 28, married Elizabeth Evelyne Best, aged 23, in April 1893 in Bolton, Lancashire, England. They had six children:  
William Roocroft<sup>113</sup> in 1893  
Alice Roocroft<sup>114</sup> in 1894  
Ethel Roocroft<sup>116</sup> in 1895  
James Roocroft<sup>101</sup> in 1897  
Thomas Harold Roocroft<sup>118</sup> in 1898  
Edward Walsh Roocroft<sup>119</sup> in 1901  
*This family is shown as family tree 51.*
139. JOHN ATKINSON (Andrew's great-grandfather<sup>69</sup>, see Maternal Ancestry) was born on 8 June 1862, in Bolton, Lancashire, England, to James Atkinson<sup>173</sup> and Jane Hodson<sup>174</sup>, as shown in family tree 62. He died in 1953, aged about 91.
- 
140. MARY ELLEN MARSDEN (Andrew's great-grandmother<sup>70</sup>, see Maternal Ancestry) was born in April 1861, in Halliwell, Bolton, Lancashire, England, to Thomas Marsden<sup>176</sup> and Elizabeth (Betty) Bolton<sup>177</sup>, as shown in family tree 64. She died on 3 November 1915, aged 54, in Bolton, Lancashire, England.  
John Atkinson<sup>139</sup>, aged 23, married Mary Ellen Marsden, aged 24, in October 1885 in Bolton, Lancashire, England. They had two daughters:  
Linda Marsden Atkinson<sup>120</sup> in 1898  
Dora Marsden Atkinson<sup>102</sup> in 1899  
*This family is shown as family tree 52.*
- 
141. ELLEN JAMESON (Andrew's great-great-aunt<sup>80</sup>) was born in September 1845, in Wigan, Lancashire, England, to William Jameson<sup>161</sup> and Elizabeth Arrowsmith<sup>162</sup>, as shown in family tree 57. She died about 1871, aged about 25. She was buried on 19 July 1871 in Haigh, Lancashire, England.
142. MARY JAMESON (Andrew's great-great-aunt<sup>78</sup>) was born about 1855, in Wigan, Lancashire, England, to William Jameson<sup>161</sup> and Elizabeth Arrowsmith<sup>162</sup>, as shown in family tree 57. She died in 1942, aged about 87.
143. FANNY ELIZABETH JAMESON (Andrew's great-great-aunt<sup>79</sup>) was born in December 1859, in Haigh, Lancashire, England, to William Jameson<sup>161</sup> and Elizabeth Arrowsmith<sup>162</sup>, as shown in family tree 57. She died in 1952, aged about 92.
144. WILLIAM TEMPLEMAN (Andrew's great-great-uncle<sup>86</sup>) was born to William Templeman<sup>165</sup> and Ann Allen<sup>166</sup>, as shown in family tree 59. He is no longer living.
145. HENRY TEMPLEMAN (Andrew's great-great-uncle<sup>87</sup>) was born to William Templeman<sup>165</sup> and Ann Allen<sup>166</sup>, as shown in family tree 59. He is no longer living.
146. WILLIAM ROOCROFT (Andrew's great-great-uncle<sup>116</sup>) was born on 11 April 1870, in Bolton, Lancashire, England, to Edward Roocroft<sup>169</sup> and Mary Batty<sup>170</sup>, as shown in family tree 61. In 1911, aged about 41, he resided in Bolton, Lancashire, England (Marital Status: Married; Relation to Head: Head). He died on 5 July 1943, aged 73, in Bolton, Lancashire, England.  
William married Clara Talbot<sup>147</sup>.  
William Roocroft was married in April 1897 in Bolton, Lancashire, England.
147. CLARA TALBOT (Andrew's great-great-aunt by marriage<sup>170</sup>) was born on 18 February 1873, in Bolton, Lancashire, England. She died on 13 November 1957, aged 84, in Bolton, Lancashire, England.  
William Roocroft<sup>146</sup>, aged 27, married Clara Talbot, aged 24, on 30 June 1897 in Halliwell Rd Chapel, Bolton, Lancaster, England. They had one son:  
Eric Talbot Roocroft<sup>122</sup> in 1908  
*This family is shown as family tree 53.*

148. MARY ATKINSON (Andrew's great-great-aunt<sup>125</sup>) was born in 1857, in Bolton, Lancashire, England, to James Atkinson<sup>173</sup> and Jane Hodson<sup>174</sup>, as shown in family tree 62. She died in 1925, aged about 68, in Fylde, Lancashire, England.
149. HENRY ATKINSON (Andrew's great-great-uncle<sup>124</sup>) was born in 1859, in Bolton, Lancashire, England, to James Atkinson<sup>173</sup> and Jane Hodson<sup>174</sup>, as shown in family tree 62. He died on 31 December 1896, aged about 37, in Bolton, Lancashire, England.
150. ISABELLA ATKINSON (Andrew's great-great-aunt<sup>128</sup>) was born in 1861, in Bolton, Lancashire, England, to James Atkinson<sup>173</sup> and Jane Hodson<sup>174</sup>, as shown in family tree 62. She died in 1945, aged about 84, in Bolton.
151. ELIZABETH ATKINSON (Andrew's great-great-aunt<sup>126</sup>) was born in 1865, in Bolton, Lancashire, England, to James Atkinson<sup>173</sup> and Jane Hodson<sup>174</sup>, as shown in family tree 62. She died in 1923, aged about 58, in Bolton, Lancashire, England.
- 
152. EDITH ATKINSON (Andrew's great-great-aunt<sup>127</sup>) was born in 1867, in Bolton, Lancashire, England, to James Atkinson<sup>173</sup> and Jane Hodson<sup>174</sup>, as shown in family tree 62. She died in 1939, aged about 72, in Blackpool, Lancashire, England.
153. WILLIAM THOMAS MARSDEN (Andrew's great-great-uncle<sup>132</sup>) was born in 1849, in Oswaldtwistle, Lancashire, England, to Thomas Marsden<sup>176</sup> and Elizabeth (Betty) Bolton<sup>177</sup>, as shown in family tree 64. In 1861, aged about 12, he resided in St Lawrence, Great Harwood, Lancashire, England (Relation to Head of House: Son). He died about 1862, aged about 13. He was buried on 2 June 1862 in Great Harwood, Lancashire, England.
154. JAMES MARSDEN (Andrew's great-great-uncle<sup>135</sup>) was born in 1853, in Great Harwood, Lancashire, England, to Thomas Marsden<sup>176</sup> and Elizabeth (Betty) Bolton<sup>177</sup>, as shown in family tree 64. In 1861, aged about 8, he resided in St Lawrence, Great Harwood, Lancashire, England (Relation to Head of House: Son). He resided in Blackburn. He died about 1881, aged about 28. James was buried on 22 February 1881 in Great Harwood, Lancashire, England.
155. ROBERT MARSDEN (Andrew's great-great-uncle<sup>133</sup>) was born in 1856, in Halliwell, Lancashire, England, to Thomas Marsden<sup>176</sup> and Elizabeth (Betty) Bolton<sup>177</sup>, as shown in family tree 64. In 1861, aged about 5, he resided in St Lawrence, Great Harwood, Lancashire, England (Relation to Head of House: Son). In 1901, aged about 45, he resided in Bolton, Daubhill, and Rumworth, Bolton, Lancashire, England (Relation to Head of House: Head). He died in December 1904, aged about 48, in Lancashire, United Kingdom.  
Robert married Martha Wilkinson<sup>156</sup>.  
Robert fathered one daughter:  
Cissie Marsden<sup>124</sup> in 1916  
*This family is shown as family tree 55.*
156. MARTHA WILKINSON (Andrew's great-great-aunt by marriage<sup>185</sup>) was born in 1855, in Blackburn, Lancashire, England. In 1901, aged about 46, she resided in Bolton, Daubhill, and Rumworth, Bolton, Lancashire, England (Relation to Head of House: Wife). She died in April 1928, aged about 72, in Bolton Lancashire 8c / 352.  
Robert Marsden<sup>155</sup>, aged about 20, married Martha Wilkinson, aged about 21, in October 1876 in Bolton Lancashire. They had one son:  
Thomas Marsden<sup>126</sup> in 1877  
*This family is shown as family tree 54.*
157. JOHN MARSDEN (Andrew's great-great-uncle<sup>134</sup>) was born in 1858, in Great Harwood, Lancashire, England, to Thomas Marsden<sup>176</sup> and Elizabeth (Betty) Bolton<sup>177</sup>, as shown in family tree 64. In 1861, aged about 3, he resided in St Lawrence, Great Harwood, Lancashire, England (Relation to Head of House: Son). He died in 1924, aged about 66.

158. RICHARD (DICK) MARSDEN (Andrew's great-great-uncle<sup>131</sup>) was born in 1865, in Bolton, Lancashire, England, to Thomas Marsden<sup>176</sup> and Elizabeth (Betty) Bolton<sup>177</sup>, as shown in family tree 64. He was baptised on 12 February 1865, in Bolton-le-Moors, Lancashire, England. In 1891, aged about 26, he resided in Edge Fold, St George the Martyr, Middle Hulton, Lancashire, England (Relation to Head of House: Son). In 1921, aged about 56, he resided in Kearsley, Lancashire, England (Occupation: General laborer; Marital Status: Married; Relation to Head of House: Head). Richard died in October 1944, aged about 79.



159. AMY ANN WOODWARD (Andrew's great-great-aunt by marriage<sup>184</sup>) was born in 1862, in Westhoughton Bolton Lancashire 8c / 219, to Richard Woodward and Mary Ann Atkinson. In 1911, aged about 49, she resided in Bolton, Lancashire, England (Marital Status: Married; Relation to Head of House: Wife). In 1921, aged about 59, she resided in Kearsley, Lancashire, England (Occupation: Housewife; Marital Status: Married; Relation to Head of House: Wife). She died in July 1936, aged about 74, in Bolton, Lancashire, England.



Richard (Dick) Marsden<sup>158</sup> married Amy Ann Woodward. They had three daughters:  
 Edith Marsden<sup>128</sup> in 1897  
 Mary (Polly) Elizabeth Marsden<sup>129</sup> in 1899  
 Elsie Marsden<sup>131</sup> in 1902

*This family is shown as family tree 56.*

160. JANE ANNE STIMSON (Andrew's cousin, three times removed<sup>213</sup>) was born about 1856, in Wansford, Northamptonshire, England, to John Stimson<sup>182</sup> and Sarah Posnette<sup>183</sup>, as shown in family tree 66. She died in January 1924, aged about 67, in Kings Norton, Warwickshire, England.

### Generation of Great-Great-Grandparents

161. WILLIAM JAMESON (Andrew's great-great-grandfather<sup>76</sup>, see Paternal Ancestry) was born about 1824, in Wigan, Lancashire, England, to Peter Jameson<sup>186</sup> and Frances (Fanny) Hadkin<sup>187</sup>, as shown in family tree 67. He died in May 1916, aged about 91.

162. ELIZABETH ARROWSMITH (Andrew's great-great-grandmother<sup>77</sup>, see Paternal Ancestry) was born about 1823, in Winstanley, Lancashire, England, to John Arrowsmith<sup>188</sup>, as shown within family tree 57. She died in August 1898, aged about 75, in Wigan, Lancashire, United Kingdom.

William Jameson<sup>161</sup>, aged about 19, married Elizabeth Arrowsmith, aged about 20, on 19 February 1844 in St John the Divine, Pemberton, Lancashire, England. They had four children:

Ellen Jameson<sup>141</sup> in 1845  
 John Jameson<sup>133</sup> in 1850  
 Mary Jameson<sup>142</sup> about 1855  
 Fanny Elizabeth Jameson<sup>143</sup> in 1859

*This family is shown as family tree 57.*

163. EDWARD CORRIS (Andrew's great-great-grandfather<sup>81</sup>, see Paternal Ancestry) was born in January 1815, in Patrick, Glenfaba, Isle of Man, Isle of Man, United Kingdom, to Simon Corris<sup>189</sup> and Elizabeth Cowin<sup>190</sup>, as shown in family tree 68. He died in December 1893, aged 78, in Birkenhead, Cheshire, England. Edward married Jane Harrison<sup>164</sup>.

Edward Corris was married on 6 September 1838 in Lancashire, United Kingdom.

164. JANE HARRISON (Andrew's great-great-grandmother<sup>82</sup>, see Paternal Ancestry) was born on 20 December 1816, in Tranmere, Cheshire, England, to Richard Harrison<sup>191</sup> and Mary Oxton<sup>192</sup>, as shown within family tree 58. She died on 7 November 1878, aged 61, in Rock Ferry, Cheshire, England, United Kingdom.



Edward Corris<sup>163</sup>, aged 23, married Jane Harrison, aged 21, on 6 September 1838 in Liverpool, St Peter, Lancashire, England. They had one daughter:

Mary Elizabeth Corris<sup>134</sup> in 1846

*This family is shown as family tree 58.*

165. WILLIAM TEMPLEMAN (Andrew's great-great-grandfather<sup>84</sup>, see Paternal Ancestry) was born in December 1822, in Market Deeping, Lincolnshire, to Robert Templeman<sup>193</sup> and Mary Reedman<sup>194</sup>, as shown within family tree 59. He died in January 1904, aged 81.

166. ANN ALLEN (Andrew's great-great-grandmother<sup>85</sup>, see Paternal Ancestry) was born in June 1814, in Essendine, Rutland, to Robert Allen<sup>195</sup> and Ann Briggs<sup>196</sup>, as shown within family tree 50. She died in February 1883, aged 68.  
Ann married William Templeman<sup>165</sup>.  
Ann Allen was married in October 1842 in Stamford, Lincolnshire, United Kingdom.  
William Templeman<sup>165</sup> married Ann Allen. They had three sons:  
William Templeman<sup>144</sup>  
Henry Templeman<sup>145</sup>  
Thomas Templeman<sup>135</sup> in 1857  
*This family is shown as family tree 59.*
167. AMOS COBB (Andrew's great-great-grandfather<sup>88</sup>, see Paternal Ancestry) was born in 1826, in Wellingbor, Northamptonshire, England, to John Cobb<sup>197</sup> and Rebecca Payne<sup>198</sup>, as shown within family tree 60. He died in 1888, aged about 62, in Warwick, Warwickshire.
168. JANE STIMSON (Andrew's great-great-grandmother<sup>89</sup>, see Paternal Ancestry) was born about 1828, in Yarwell, Northamptonshire, England, to William Stimson<sup>199</sup> and Catherine Lattimore<sup>200</sup>, as shown in family tree 69. She died in January 1901, aged about 72, in Coventry, Warwickshire, West Midlands, United Kingdom.  
Amos Cobb<sup>167</sup> married Jane Stimson. They had one daughter:  
Jane Cobb<sup>136</sup> in 1856  
*This family is shown as family tree 60.*
169. EDWARD ROOCROFT (Andrew's great-great-grandfather<sup>114</sup>, see Maternal Ancestry) was born in 1830, in Cartmel, Lancashire, England, to Richard Roocroft<sup>201</sup> and Catherine Charlotte Atkinson<sup>202</sup>, as shown in family tree 70. In 1881, aged about 51, he resided in Halliwell, Lancashire, England (Marital Status: Married; Relation to Head of House: Head; Occupation: Confectioner). He died on 23 January 1889, aged about 58, in Bolton, Lancashire, England.  
  
The following information is also recorded for Edward. Probate: on 7 March 1889, in Manchester, England.
170. MARY BATTY (Andrew's great-great-grandmother<sup>115</sup>, see Maternal Ancestry) was born about 1834, in Newton in Lonsdale, to James Altham Batty<sup>203</sup> and Mary Ann Brayshaw<sup>204</sup>, as shown within family tree 61. She died on 7 September 1901, aged about 67, in Bolton, Lancashire, England.  
  
Edward Roocroft<sup>169</sup>, aged about 22, married Mary Batty, aged about 18, in 1852 in Settle, Yorkshire, England. They had two sons:  
Robert Roocroft<sup>137</sup> in 1865  
William Roocroft<sup>146</sup> in 1870  
*This family is shown as family tree 61.*
171. THOMAS WALSH BEST (Andrew's great-great-grandfather<sup>117</sup>, see Maternal Ancestry) was born in 1837, in Bolton, Lancashire, England. He was baptised on 13 August 1837, in Bolton-le-Moors, St Peter, Lancashire, England. He died on 23 January 1907, aged about 69, in Lancashire, England.
172. MARY ANN ASHBURN (Andrew's great-great-grandmother<sup>118</sup>, see Maternal Ancestry) was born in 1839, in Bolton, Lancashire, England, to James Ashburn<sup>205</sup> and Elizabeth McAlpine<sup>206</sup>, as shown within family tree 51. She died in December 1922, aged about 83, in Salford, Lancashire, England.  
Thomas Walsh Best<sup>171</sup> married Mary Ann Ashburn. They had one daughter:  
Elizabeth Evelyne Best<sup>138</sup> in 1869  
*This family is shown within family tree 51.*
173. JAMES ATKINSON (Andrew's great-great-grandfather<sup>122</sup>, see Maternal Ancestry) was born in 1833, in Garstang, Lancashire, England, to Christopher Atkinson<sup>207</sup> and Mary Wright<sup>208</sup>, as shown in family tree 71. He died in April 1890, aged about 56, in Bolton, Lancashire, England.
174. JANE HODSON (Andrew's great-great-grandmother<sup>123</sup>, see Maternal Ancestry) was born on 15 July 1839, in Bolton, Lancashire, England, to Sarah Hodson<sup>209</sup>. She died in July 1911, aged 72, in Fylde, Lancashire.  
  
Jane married twice. She was married to James Atkinson<sup>173</sup> and Matthew Lofthouse<sup>175</sup>.  
James Atkinson<sup>173</sup>, aged about 23, married Jane Hodson, aged 17, on 19 November 1856 in Bolton-le-Moors, Lancashire, England. They had six children:  
Mary Atkinson<sup>148</sup> in 1857  
Henry Atkinson<sup>149</sup> in 1859  
Isabella Atkinson<sup>150</sup> in 1861  
John Atkinson<sup>139</sup> in 1862  
Elizabeth Atkinson<sup>151</sup> in 1865  
Edith Atkinson<sup>152</sup> in 1867  
*This family is shown as family tree 62.*

175. MATTHEW LOFTHOUSE (Andrew's step-great-great-grandfather<sup>177</sup>) was born about 1838, in Burley, Yorkshire, England. He died on 19 June 1914, aged about 75, in Blackpool, Lancashire, England.  
Matthew Lofthouse, aged about 52, married Jane Hodson<sup>174</sup>, aged 51, on 27 June 1891 in Bolton, Lancashire, England. See family tree 63.
176. THOMAS MARSDEN (Andrew's great-great-grandfather<sup>129</sup>, see Maternal Ancestry) was born in 1828, in Chorley, Lancashire, England, to Robert Marsden<sup>210</sup> and Mary Bibby<sup>211</sup>, as shown in family tree 72. In 1891, aged about 63, he resided in Ramsbottom, St Andrew, Tottington Lower End, Lancashire, England (Relation to Head of House: Head). He died in January 1906, aged about 77, in Doncaster, Yorkshire West Riding.
177. ELIZABETH (BETTY) BOLTON (Andrew's great-great-grandmother<sup>130</sup>, see Maternal Ancestry) was born in 1827, in Bolton, Lancashire, England, to John Bolton<sup>212</sup> and Sarah Morris<sup>213</sup>, as shown in family tree 73.  In 1851, aged about 24, she resided in Sharples, Lancashire, England (Relation to Head of House: Daughter). In 1861, aged about 34, she resided in St Lawrence, Great Harwood, Lancashire, England (Relation to Head of House: Wife). In 1891, aged about 64, she resided in Edge Fold, St George the Martyr, Middle Hulton, Lancashire, England (Relation to Head of House: Wife). Elizabeth died in June 1879, aged about 51.  
Thomas Marsden<sup>176</sup> married Elizabeth (Betty) Bolton. They had six children:  
William Thomas Marsden<sup>153</sup> in 1849  
James Marsden<sup>154</sup> in 1853  
Robert Marsden<sup>155</sup> in 1856  
John Marsden<sup>157</sup> in 1858  
Mary Ellen Marsden<sup>140</sup> in 1861  
Richard (Dick) Marsden<sup>158</sup> in 1865  
*This family is shown as family tree 64.*
178. JANE JAMESON (Andrew's great-great-great-aunt<sup>142</sup>) was born about 1838, in Haigh, Lancashire, England, to Peter Jameson<sup>186</sup> and Frances (Fanny) Hadkin<sup>187</sup>, as shown in family tree 67. She is no longer living.
179. PETER JAMESON (Andrew's great-great-great-uncle<sup>141</sup>) was born in 1845, in Haigh, Lancashire, England, to Peter Jameson<sup>186</sup> and Frances (Fanny) Hadkin<sup>187</sup>, as shown in family tree 67. He died on 5 October 1919, aged about 74, in Wigan, Lancashire, England.
180. ANN STIMSON (Andrew's great-great-great-aunt<sup>157</sup>) was born in 1814 to William Stimson<sup>199</sup> and Catherine Lattimore<sup>200</sup>, as shown in family tree 69. She was baptised on 27 November 1814, in Yarwell, Northampton, England. She is no longer living.
181. MR. PEASGOOD (Andrew's great-great-great-uncle by marriage<sup>214</sup>). He is no longer living.  
Mr. Peasgood married Ann Stimson<sup>180</sup>. See family tree 65.
182. JOHN STIMSON (Andrew's great-great-great-uncle<sup>156</sup>) was born in 1823, in Garwell, Northamptonshire, England, to William Stimson<sup>199</sup> and Catherine Lattimore<sup>200</sup>, as shown in family tree 69. He was baptised on 27 July 1823, in Northamptonshire, England. He died in April 1902, aged about 78, in Long Ashton, Somerset, England.
183. SARAH POSNETTE (Andrew's great-great-great-aunt by marriage<sup>212</sup>) was born in January 1820, in Market Deeping, Lincolnshire, England. She died in March 1900, aged 80, in Long Ashton, Somerset, England.  
John Stimson<sup>182</sup>, aged about 39, married Sarah Posnette, aged 43, on 24 May 1863 in Saint John, Coventry, Warwick, England. They had one daughter:  
Jane Anne Stimson<sup>160</sup> about 1856  
*This family is shown as family tree 66.*
184. SARAH BOLTON (Andrew's great-great-great-aunt<sup>183</sup>) was born about 1824, in Bolton, Lancashire, England, to  John Bolton<sup>212</sup> and Sarah Morris<sup>213</sup>, as shown in family tree 73. She is no longer living.
185. HANNAH BOLTON (Andrew's great-great-great-aunt<sup>182</sup>) was born in 1827 to John Bolton<sup>212</sup> and Sarah Morris<sup>213</sup>, as shown in family tree 73. She is no longer living.

**Generation of Great-Great-Great-Grandparents**

186. PETER JAMESON (Andrew's great-great-great-grandfather<sup>139</sup>, see Paternal Ancestry) was born on 22 September 1800, in Wigan, Lancashire, England, to Margaret Jameson<sup>214</sup>, as shown in family tree 75. He was baptised on 13 October 1800, in Wigan, All Saints, Lancashire, England. In 1851, aged about 50, he resided in Haigh, Lancashire, England (Relation to Head of House: Head). He died on 16 January 1875, aged 74, in Wigan, Lancashire. Peter was buried on 16 January 1875 in Haigh, Lancashire, England.
187. FRANCES (FANNY) HADKIN (Andrew's great-great-great-grandmother<sup>140</sup>, see Paternal Ancestry) was born about 1800, in Wigan, Lancashire, England. She died in December 1858, aged about 58, in Haigh, Wigan, Lancashire, England.  
 Peter Jameson<sup>186</sup>, aged 19, married Frances (Fanny) Hadkin, aged about 19, on 4 June 1820 in Saint Peter, Bolton Le Moors, Lancashire, England. They had three children:  
 William Jameson<sup>161</sup> about 1824  
 Jane Jameson<sup>178</sup> about 1838  
 Peter Jameson<sup>179</sup> in 1845  
*This family is shown as family tree 67.*
188. JOHN ARROWSMITH (Andrew's great-great-great-grandfather<sup>143</sup>, see Paternal Ancestry). He is no longer living.  
 John fathered one daughter:  
 Elizabeth Arrowsmith<sup>162</sup> about 1823  
*This family is shown within family tree 57.*
189. SIMON CORRIS (Andrew's great-great-great-grandfather<sup>144</sup>, see Paternal Ancestry) was born in 1774, in Isle of Man, to William Corris<sup>216</sup> and Margaret Cowley<sup>217</sup>, as shown within family tree 68. He died on 31 December 1841, aged about 67, in Patrick Isle Of Man.
190. ELIZABETH COWIN (Andrew's great-great-great-grandmother<sup>145</sup>, see Paternal Ancestry) was born on 10 October 1773, in Isle of Man, to Thomas Cowin<sup>218</sup> and Elizabeth Clague<sup>219</sup>, as shown within family tree 58. She died on 13 June 1852, aged 78, in Isle of Man, United Kingdom.  
 Simon Corris<sup>189</sup>, aged about 20, married Elizabeth Cowin, aged 21, on 16 November 1794 in Kirk German, Isle of Man, England. They had one son:  
 Edward Corris<sup>163</sup> in 1815  
*This family is shown as family tree 68.*
191. RICHARD HARRISON (Andrew's great-great-great-grandfather<sup>146</sup>, see Paternal Ancestry) was born about 1769, in Thurston, Cheshire, England. He died about 1845, aged about 76, in Lower Tranmere, Cheshire, England.
192. MARY OXTON (Andrew's great-great-great-grandmother<sup>147</sup>, see Paternal Ancestry) was born about 1780, in Greasby, Cheshire, England, to Thomas Oxtan<sup>220</sup> and Jane Middleton<sup>221</sup>, as shown within family tree 58. She is no longer living.  
 Richard Harrison<sup>191</sup> married Mary Oxtan. They had one daughter:  
 Jane Harrison<sup>164</sup> in 1816  
*This family is shown within family tree 58.*
193. ROBERT TEMPLEMAN (Andrew's great-great-great-grandfather<sup>148</sup>, see Paternal Ancestry) was born on 8 November 1789, in Market Deeping, Lincolnshire, England, to William Roy Templeman<sup>222</sup> and Betty Mary Schwab<sup>223</sup>, as shown within family tree 59. He died on 21 March 1850, aged 60, in Market Deeping, Lincolnshire, England.
194. MARY REEDMAN (Andrew's great-great-great-grandmother<sup>149</sup>, see Paternal Ancestry) was born in 1793, in Tallington, Lincolnshire, England, to Robert Reedman<sup>224</sup> and Ann Batteram<sup>225</sup>, as shown within family tree 59. She died in June 1883, aged about 89, in Lincolnshire, United Kingdom.  
 Robert Templeman<sup>193</sup> married Mary Reedman. They had one son:  
 William Templeman<sup>165</sup> in 1822  
*This family is shown within family tree 59.*
195. ROBERT ALLEN (Andrew's great-great-great-grandfather<sup>150</sup>, see Paternal Ancestry) was born about 1780, in Northamptonshire, England. He is no longer living.
196. ANN BRIGGS (Andrew's great-great-great-grandmother<sup>151</sup>, see Paternal Ancestry) was born about 1780. She is no longer living.  
 Robert Allen<sup>195</sup> married Ann Briggs. They had one daughter:  
 Ann Allen<sup>166</sup> in 1814  
*This family is shown within family tree 50.*

197. JOHN COBB (Andrew's great-great-great-grandfather<sup>152</sup>, see Paternal Ancestry) was born about 1792, in Wellingborough, Northamptonshire, England, to William Cobb<sup>226</sup> and Elizabeth Berry<sup>227</sup>, as shown within family tree 60. He died in October 1872, aged about 80, in Wellingborough, Northamptonshire, United Kingdom.
198. REBECCA PAYNE (Andrew's great-great-great-grandmother<sup>153</sup>, see Paternal Ancestry) was born on 28 October 1788, in Warkton, Northamptonshire, England, to William Wm Payne<sup>228</sup> and Elizabeth Leggin<sup>229</sup>, as shown within family tree 60. She died on 26 February 1870, aged 81, in Wellingborough, Northamptonshire, England.  
John Cobb<sup>197</sup> married Rebecca Payne. They had one son:  
Amos Cobb<sup>167</sup> in 1826  
*This family is shown within family tree 60.*
199. WILLIAM STIMSON (Andrew's great-great-great-grandfather<sup>154</sup>, see Paternal Ancestry) was born in 1795, in Stibbington, Huntingdonshire, England. He died in June 1867, aged about 71, in Norfolk, England.
200. CATHERINE LATTIMORE (Andrew's great-great-great-grandmother<sup>155</sup>, see Paternal Ancestry) was born in 1795, in Yarwell, Northamptonshire, England, to Edward Green Lattimore<sup>230</sup> and Ann Norris<sup>231</sup>, as shown within family tree 60. She died in April 1867, aged about 71, in Stamford, Huntingdonshire, Northamptonshire, United Kingdom.  
William Stimson<sup>199</sup>, aged about 19, married Catherine Lattimore, aged about 19, on 11 July 1814 in Yarwell, Northamptonshire, England. They had three children:  
Ann Stimson<sup>180</sup> in 1814  
John Stimson<sup>182</sup> in 1823  
Jane Stimson<sup>168</sup> about 1828  
*This family is shown as family tree 69.*
201. RICHARD ROOCROFT (Andrew's great-great-great-grandfather<sup>166</sup>, see Maternal Ancestry) was born on 24 January 1785, in Ulnes Walton, Lancashire, England, to John Roorcroft<sup>232</sup> and Elizabeth Rigby<sup>233</sup>, as shown within family tree 70. He died about 1856, aged about 71.
202. CATHERINE CHARLOTTE ATKINSON (Andrew's great-great-great-grandmother<sup>167</sup>, see Maternal Ancestry) was born on 9 December 1798, in Milnthorpe, Westmorland, England, to John Atkinson<sup>234</sup> and Katharine Prickett<sup>235</sup>, as shown within family tree 61. She died on 31 December 1866, aged 68, in Preston, Lancashire, England, United Kingdom.  
Richard Roorcroft<sup>201</sup> married Catherine Charlotte Atkinson. They had one son:  
Edward Roorcroft<sup>169</sup> in 1830  
*This family is shown as family tree 70.*
203. JAMES ALTHAM BATTY (Andrew's great-great-great-grandfather<sup>168</sup>, see Maternal Ancestry) was born on 27 April 1798, in Burton in Lonsdale, Yorkshire, England, to Thomas Batty<sup>236</sup> and Elizabeth Moore<sup>237</sup>, as shown within family tree 61. He died in October 1878, aged 80, in Wakefield, Yorkshire West Riding.
204. MARY ANN BRAYSHAW (Andrew's great-great-great-grandmother<sup>169</sup>, see Maternal Ancestry) was born in February 1795, in Burton, Yorkshire, England, to William Brayshaw<sup>238</sup> and Alice Downham<sup>239</sup>, as shown within family tree 61. She died on 4 July 1856, aged 61, in Burton in Lonsdale, Yorkshire, England.  
James Altham Batty<sup>203</sup> married Mary Ann Brayshaw. They had one daughter:  
Mary Batty<sup>170</sup> about 1834  
*This family is shown within family tree 61.*
205. JAMES ASHBURN (Andrew's great-great-great-grandfather<sup>172</sup>, see Maternal Ancestry) was born about 1805, in Manchester, Lancashire, England. He died in March 1875, aged about 69, in Lancashire, United Kingdom.
206. ELIZABETH MCALPINE (Andrew's great-great-great-grandmother<sup>173</sup>, see Maternal Ancestry) was born about 1816, in Manchester, Lancashire, England. She died in June 1852, aged about 35, in Lancashire, United Kingdom.  
James Ashburn<sup>205</sup>, aged about 30, married Elizabeth McAlpine, aged about 19, on 17 November 1835 in Manchester, Lancashire, England. They had one daughter:  
Mary Ann Ashburn<sup>172</sup> in 1839  
The following information is also recorded for this family. Marriage(?) on 19 June 1850, in Manchester, St Mary, St Denys and St George, Lancashire, England, when James was aged 44 and Elizabeth was aged 33.  
*This family is shown within family tree 51.*
207. CHRISTOPHER ATKINSON (Andrew's great-great-great-grandfather<sup>174</sup>, see Maternal Ancestry) was born in 1792, in Stalmine, Lancashire, England, to William Atkinson<sup>240</sup> and Isabella Summers<sup>241</sup>, as shown in family tree 76. He died in 1858, aged about 66, in Bolton, Lancashire, England.

208. MARY WRIGHT (Andrew's great-great-great-grandmother<sup>175</sup>, see Maternal Ancestry) was born about August 1799, in Cabus, Lancashire, England, to Thomas Wright<sup>242</sup> and Peggy (Margaret) Huntington<sup>243</sup>, as shown within family tree 62. She died in 1868, aged about 68, in Bolton, Lancashire, England.  
Christopher Atkinson<sup>207</sup>, aged about 27, married Mary Wright, aged about 20, on 20 March 1820 in Garstang, Lancashire, England. They had one son:  
James Atkinson<sup>173</sup> in 1833  
*This family is shown as family tree 71.*
209. SARAH HODSON (Andrew's great-great-great-grandmother<sup>176</sup>, see Maternal Ancestry) was born in 1819, in Bolton, Lancashire, England. She died on 21 October 1835, aged about 16, in Bolton, Lancashire, England.  
Sarah gave birth to one daughter:  
Jane Hodson<sup>174</sup> in 1839  
*This family is shown within family tree 63.*
210. ROBERT MARSDEN (Andrew's great-great-great-grandfather<sup>178</sup>, see Maternal Ancestry) was born on 3 September 1790, in Dean, Lancashire, England, to Peter Marsden<sup>244</sup> and Ann (Nancy) Harwood<sup>245</sup>, as shown in family tree 77. He was baptised on 29 September 1790, in Horwich, Lancashire, England. In 1841, aged about 50, he resided in Crumpsall, Manchester, Lancashire, England. He died in 1835, aged about 44, in Lancashire.
211. MARY BIBBY (Andrew's great-great-great-grandmother<sup>179</sup>, see Maternal Ancestry) was born in 1797, in Levenshulme, Lancashire, England. She died in April 1873, aged about 75, in Rochdale, Lancashire.  
Robert Marsden<sup>210</sup> married Mary Bibby. They had one son:  
Thomas Marsden<sup>176</sup> in 1828  
*This family is shown as family tree 72.*
212. JOHN BOLTON (Andrew's great-great-great-grandfather<sup>180</sup>, see Maternal Ancestry) was born about 1784, in Wigan, Lancashire, England. In 1851, aged about 67, he resided in Sharples, Lancashire, England (Relation to Head of House: Head). He is no longer living.
213. SARAH MORRIS (Andrew's great-great-great-grandmother<sup>181</sup>, see Maternal Ancestry) was born in Bolton, Lancashire, England. She is no longer living.  
John Bolton<sup>212</sup> married Sarah Morris. They had three daughters:  
Sarah Bolton<sup>184</sup> about 1824  
Hannah Bolton<sup>185</sup> in 1827  
Elizabeth (Betty) Bolton<sup>177</sup> in 1827  
*This family is shown as family tree 73.*

### **Generation of Four-Times-Great-Grandparents**

214. MARGARET JAMESON (Andrew's four-times-great-grandmother<sup>195</sup>, see Paternal Ancestry) was born on 26 August 1779, in Wigan, Lancashire, England, to James Jameson<sup>251</sup> and Mary Woods<sup>252</sup>, as shown within family tree 74. She was baptised on 11 September 1779, in Wigan, Lancashire, England. She resided in Wigan, Lancashire. She resided in Wigan, Lancashire, England. Margaret died in October 1818, aged 39. She was buried in Wigan, Metropolitan Borough of Wigan, Greater Manchester, England.  
Margaret married William Gaskell<sup>215</sup>.  
Margaret gave birth to one son:  
Peter Jameson<sup>186</sup> in 1800  
*This family is shown as family tree 75.*
215. WILLIAM GASKELL (Andrew's four-times-great-grandmother's husband<sup>241</sup>). William resided in Wigan, Lancashire, England. He is no longer living.  
William Gaskell married Margaret Jameson<sup>214</sup>, aged 19, on 1 April 1799 in Wigan, All Saints, Lancashire, England. See family tree 74.
216. WILLIAM CORRIS (Andrew's four-times-great-grandfather<sup>196</sup>, see Paternal Ancestry) was born in 1720, in Kirk German, Isle of Man, England, to Patrick Corris<sup>253</sup> and Catherine Callister<sup>254</sup>, as shown within family tree 68. He died on 7 March 1774, aged about 53, in Patrick, Glenfaba, Isle of Man.
217. MARGARET COWLEY (Andrew's four-times-great-grandmother<sup>197</sup>, see Paternal Ancestry) was born on 5 March 1720, in Ballaugh, Michael, Isle of Man, to William Cowley<sup>255</sup> and Catherine Cubbon<sup>256</sup>, as shown within family tree 68. She died on 29 September 1783, aged 63, in Patrick Isle Of Man.  
William Corris<sup>216</sup>, aged about 24, married Margaret Cowley, aged 24, on 14 August 1744 in Patrick, Isle of Man, England. They had one son:  
Simon Corris<sup>189</sup> in 1774  
*This family is shown within family tree 68.*

218. THOMAS COWIN (Andrew's four-times-great-grandfather<sup>198</sup>, see Paternal Ancestry) was born about 1753. He is no longer living.
219. ELIZABETH CLAGUE (Andrew's four-times-great-grandmother<sup>199</sup>, see Paternal Ancestry) was born about 1753. She is no longer living.  
 Thomas Cowin<sup>218</sup> married Elizabeth Clague. They had one daughter:  
 Elizabeth Cowin<sup>190</sup> in 1773  
*This family is shown within family tree 58.*
220. THOMAS OXTON (Andrew's four-times-great-grandfather<sup>200</sup>, see Paternal Ancestry) was born about 1752, in West Kirby, Cheshire, England. He died in June 1842, aged about 89, in Storeton, Cheshire, England.
221. JANE MIDDLETON (Andrew's four-times-great-grandmother<sup>201</sup>, see Paternal Ancestry) was born on 5 September 1749, in Upton by Birkenhead, Cheshire, England. She died in Cheshire, England.  
 Thomas Oxtan<sup>220</sup> married Jane Middleton. They had one daughter:  
 Mary Oxtan<sup>192</sup> about 1780  
*This family is shown within family tree 58.*
222. WILLIAM ROY TEMPLEMAN (Andrew's four-times-great-grandfather<sup>202</sup>, see Paternal Ancestry) was born in June 1769, in Carlby, Lincolnshire, England. He is no longer living.
223. BETTY MARY SCHWAB (Andrew's four-times-great-grandmother<sup>203</sup>, see Paternal Ancestry) was born in 1765. She died about 1795, aged about 30.  
 William Roy Templeman<sup>222</sup> married Betty Mary Schwab. They had one son:  
 Robert Templeman<sup>193</sup> in 1789  
*This family is shown within family tree 59.*
224. ROBERT REEDMAN (Andrew's four-times-great-grandfather<sup>204</sup>, see Paternal Ancestry) was born on 4 April 1770, in Tallington West Deeping Lincolnshire. He died in January 1851, aged 80, in Langtoft Lincolnshire.
225. ANN BATTERAM (Andrew's four-times-great-grandmother<sup>205</sup>, see Paternal Ancestry) was born in 1771, in 1670580, Lincolnshire, England. She died in September 1852, aged about 81, in 1670580, Lincolnshire, England.  
 Robert Reedman<sup>224</sup> married Ann Batteram. They had one daughter:  
 Mary Reedman<sup>194</sup> in 1793  
*This family is shown within family tree 59.*
226. WILLIAM COBB (Andrew's four-times-great-grandfather<sup>206</sup>, see Paternal Ancestry) was born in 1765, in Wellingborough, All Hallows, Northamptonshire, England. He is no longer living.
227. ELIZABETH BERRY (Andrew's four-times-great-grandmother<sup>207</sup>, see Paternal Ancestry) was born in 1759. She died in January 1830, aged about 70, in Wellingborough, Northamptonshire, England.  
 William Cobb<sup>226</sup> married Elizabeth Berry. They had one son:  
 John Cobb<sup>197</sup> about 1792  
*This family is shown within family tree 60.*
228. WILLIAM WM PAYNE (Andrew's four-times-great-grandfather<sup>208</sup>, see Paternal Ancestry) was born on 19 February 1759, in Northamptonshire, England. He died about 1819, aged about 60, in Warkton, Northamptonshire, England.
229. ELIZABETH LEGGIN (Andrew's four-times-great-grandmother<sup>209</sup>, see Paternal Ancestry) was born about 1760, in Northamptonshire, England. She died in England.  
 William Wm Payne<sup>228</sup> married Elizabeth Leggin. They had one daughter:  
 Rebecca Payne<sup>198</sup> in 1788  
*This family is shown within family tree 60.*
230. EDWARD GREEN LATTIMORE (Andrew's four-times-great-grandfather<sup>210</sup>, see Paternal Ancestry) was born about 1775, in Northamptonshire County, England, United Kingdom. He died about 1830, aged about 55, in Cambridgeshire, England, United Kingdom.
231. ANN NORRIS (Andrew's four-times-great-grandmother<sup>211</sup>, see Paternal Ancestry) was born about 1775, in Nassington, Northamptonshire, England. She died about 1807, aged about 32.  
 Edward Green Lattimore<sup>230</sup> married Ann Norris. They had one daughter:  
 Catherine Lattimore<sup>200</sup> in 1795  
*This family is shown within family tree 60.*

232. JOHN ROOCROFT (Andrew's four-times-great-grandfather<sup>215</sup>, see Maternal Ancestry) was born on 16 March 1757, in Croston, Lancashire, to James Roocroft<sup>257</sup> and Sarah Johnson<sup>258</sup>, as shown within family tree 70. He died on 4 December 1801, aged 44, in Ulnes Walton, Croston, Lancashire.
233. ELIZABETH RIGBY (Andrew's four-times-great-grandmother<sup>216</sup>, see Maternal Ancestry) was born in 1762, in Upholland, Lancashire, England. She died in 1814, aged about 52, in Croston, Chorley, Lancashire, England.  
John Roocroft<sup>232</sup> married Elizabeth Rigby. They had one son:  
Richard Roocroft<sup>201</sup> in 1785  
*This family is shown within family tree 70.*
234. JOHN ATKINSON (Andrew's four-times-great-grandfather<sup>217</sup>, see Maternal Ancestry) was born in 1761, in Westmoreland, England. He died about 1823, aged about 62.
235. KATHARINE PRICKETT (Andrew's four-times-great-grandmother<sup>218</sup>, see Maternal Ancestry) was born on 25 May 1763, in Low Wood, Witherslack, Westmorland. She died in December 1852, aged 89, in Westmorland.  
John Atkinson<sup>234</sup> married Katharine Prickett. They had one daughter:  
Catherine Charlotte Atkinson<sup>202</sup> in 1798  
*This family is shown within family tree 61.*
236. THOMAS BATTY (Andrew's four-times-great-grandfather<sup>219</sup>, see Maternal Ancestry) was born on 27 May 1751, in Burton in Lonsdale, Yorkshire. He died in 1828, aged about 77.
237. ELIZABETH MOORE (Andrew's four-times-great-grandmother<sup>220</sup>, see Maternal Ancestry) was born on 12 June 1757, in Linton, Cambridgeshire, England. She died in January 1818, aged 60, in Cherry Hinton.  
Thomas Batty<sup>236</sup> married Elizabeth Moore. They had one son:  
James Altham Batty<sup>203</sup> in 1798  
*This family is shown within family tree 61.*
238. WILLIAM BRAYSHAW (Andrew's four-times-great-grandfather<sup>221</sup>, see Maternal Ancestry) was born in October 1764, in Horton In Ribblesdale, Yorkshire, England. He died on 4 July 1856, aged 91, in Burton in Lonsdale, Yorkshire, England.
239. ALICE DOWNHAM (Andrew's four-times-great-grandmother<sup>222</sup>, see Maternal Ancestry) was born in 1764, in Horton In Ribblesdale, Yorkshire, England. She died in June 1840, aged about 75, in Yorkshire West Riding, United Kingdom.  
William Brayshaw<sup>238</sup> married Alice Downham. They had one daughter:  
Mary Ann Brayshaw<sup>204</sup> in 1795  
*This family is shown within family tree 61.*
240. WILLIAM ATKINSON (Andrew's four-times-great-grandfather<sup>225</sup>, see Maternal Ancestry) was born on 20 February 1769, in Stalmine Lancashire England, to John Atkinson<sup>259</sup> and Mary Whiteside<sup>260</sup>, as shown within family tree 76. He died on 8 March 1847, aged 78, in Newcastle-Upon-Tyne, England.
241. ISABELLA SUMMERS (Andrew's four-times-great-grandmother<sup>226</sup>, see Maternal Ancestry) was born in 1770, in Lancashire England. She is no longer living.  
William Atkinson<sup>240</sup> married Isabella Summers. They had one son:  
Christopher Atkinson<sup>207</sup> in 1792  
*This family is shown as family tree 76.*
242. THOMAS WRIGHT (Andrew's four-times-great-grandfather<sup>227</sup>, see Maternal Ancestry) was born in 1768, in Lancashire, England. He died in May 1850, aged about 81, in Garstang, Lancashire, England.
243. PEGGY (MARGARET) HUNTINGTON (Andrew's four-times-great-grandmother<sup>228</sup>, see Maternal Ancestry) was born in November 1769, in Nateby, Lancashire, England. She died in 1863, aged about 93, in Garstang, Lancashire, England.  
Thomas Wright<sup>242</sup> married Peggy (Margaret) Huntington. They had one daughter:  
Mary Wright<sup>208</sup> about 1799  
*This family is shown within family tree 62.*
244. PETER MARSDEN (Andrew's four-times-great-grandfather<sup>229</sup>, see Maternal Ancestry) was born on 5 June 1758, in Horwich, to Joshua Marsden<sup>261</sup> and Margaret Lyptrott<sup>262</sup>, as shown within family tree 77. He died on 5 December 1825, aged 67, in Halliwell, Lancashire.

245. ANN (NANCY) HARWOOD (Andrew's four-times-great-grandmother<sup>230</sup>, see Maternal Ancestry) was born in 1759, in Heaton, Bolton, Lancashire, to George Harwood<sup>263</sup> and Alice Taylor<sup>264</sup>, as shown in family tree 78. She died on 26 February 1817, aged about 57, in Halliwell, Lancashire.  
Peter Marsden<sup>244</sup>, aged 11, married Ann (Nancy) Harwood, aged about 10, on 12 August 1769 in Prestbury, Cheshire, England. They had one son:  
Robert Marsden<sup>210</sup> in 1790  
The following information is also recorded for this family. Marriage(?) on 13 September 1780, in St Peter, Bolton-Le-Moors, Lancashire, England, when Peter was aged 22 and Ann was aged 21.  
*This family is shown as family tree 77.*
246. ROBERT HARWOOD (Andrew's four-times-great-great-uncle<sup>257</sup>) was born in 1761, in Heaton, Deane, Bolton, to George Harwood<sup>263</sup> and Alice Taylor<sup>264</sup>, as shown in family tree 78. He is no longer living.
247. GEORGE HARWOOD (Andrew's four-times-great-great-uncle<sup>258</sup>) was born in 1766, in Heaton, Deane, Bolton, to George Harwood<sup>263</sup> and Alice Taylor<sup>264</sup>, as shown in family tree 78. He died in December 1839, aged about 73, in Bolton Lancashire 21 / 122.
248. JOHN HARWOOD (Andrew's four-times-great-great-uncle<sup>256</sup>) was born about 1766, in Heaton, Deane, Bolton, to George Harwood<sup>263</sup> and Alice Taylor<sup>264</sup>, as shown in family tree 78. He died about January 1770, aged about 3, in Heaton, Bolton, Lancashire.
249. ALICE HARWOOD (Andrew's four-times-great-great-aunt<sup>260</sup>) was born about 1776, in Halliwell, Deane, to George Harwood<sup>263</sup> and Alice Taylor<sup>264</sup>, as shown in family tree 78. She is no longer living.
250. JOHN HARWOOD (Andrew's four-times-great-great-uncle<sup>259</sup>) was born about 1779, in Halliwell, Bolton, Lancashire, to George Harwood<sup>263</sup> and Alice Taylor<sup>264</sup>, as shown in family tree 78. He is no longer living.

#### **Generation of Five-Times-Great-Grandparents**

251. JAMES JAMESON (Andrew's five-times-great-grandfather<sup>239</sup>, see Paternal Ancestry) was born in 1743, in Wigan, Lancashire, England, to James Jameson<sup>265</sup> and Margaret Unknown<sup>266</sup>, as shown within family tree 74. He was christened on 25 March 1743, in Wigan, Lancashire, England. He was baptised on 25 March 1743, in Wigan, All Saints, Lancashire, England. He died on 4 January 1830, aged about 86, in Wigan Lancashire England. James was buried on 6 January 1830 in Wigan, All Saints, Lancashire, England.
252. MARY WOODS (Andrew's five-times-great-grandmother<sup>240</sup>, see Paternal Ancestry) was born on 27 January 1758, in Standishgate, Wigan, Lancashire, England. She died on 18 March 1807, aged 49, in Wigan Lancashire England.  
James Jameson<sup>251</sup>, aged about 34, married Mary Woods, aged 19, on 21 September 1777 in Upholland, St Thomas, Lancashire, England. They had one daughter:  
Margaret Jameson<sup>214</sup> in 1779  
*This family is shown within family tree 74.*
253. PATRICK CORRIS (Andrew's five-times-great-grandfather<sup>242</sup>, see Paternal Ancestry) was born in 1695, in Isle of Man. He died in 1785, aged about 90. He was buried on 19 October 1785 in Patrick, Isle of Man.
254. CATHERINE CALLISTER (Andrew's five-times-great-grandmother<sup>243</sup>, see Paternal Ancestry) was born on 27 September 1695, in Michael, Isle of Man, Isle of Man, United Kingdom. She died in March 1758, aged 62, in Michael, Isle of Man (80).  
Patrick Corris<sup>233</sup> married Catherine Callister. They had one son:  
William Corris<sup>216</sup> in 1720  
*This family is shown within family tree 68.*
255. WILLIAM COWLEY (Andrew's five-times-great-grandfather<sup>244</sup>, see Paternal Ancestry) was born in 1690, in Ballaugh, Michael, Isle of Man. He is no longer living.
256. CATHERINE CUBBON (Andrew's five-times-great-grandmother<sup>245</sup>, see Paternal Ancestry) was born on 1 June 1687, in Jurby, Michael, Isle of Man. She died in April 1740, aged 52, in Michael, Isle of Man.  
William Cowley<sup>255</sup> married Catherine Cubbon. They had one daughter:  
Margaret Cowley<sup>217</sup> in 1720  
*This family is shown within family tree 68.*
257. JAMES ROOCROFT (Andrew's five-times-great-grandfather<sup>246</sup>, see Maternal Ancestry) was born on 21 October 1725, in Ulnes Walton, Lancashire. He died on 29 October 1763, aged 38, in Ulnes Walton, Croston, Lancashire.

258. SARAH JOHNSON (Andrew's five-times-great-grandmother<sup>247</sup>, see Maternal Ancestry) was born in June 1731, in Ulnes Walton, Lancs. She died in February 1809, aged 77, in Leyland, Lancs.  
James Roorcroft<sup>257</sup> married Sarah Johnson. They had one son:  
John Roorcroft<sup>232</sup> in 1757  
*This family is shown within family tree 70.*
259. JOHN ATKINSON (Andrew's five-times-great-grandfather<sup>250</sup>, see Maternal Ancestry) was born in 1739, in Pilling, Lancashire, England, to Timothy Atkinson<sup>267</sup> and Elizabeth Higginson<sup>268</sup>, as shown within family tree 76. He died before 24 June 1802, when younger than 62.
260. MARY WHITESIDE (Andrew's five-times-great-grandmother<sup>251</sup>, see Maternal Ancestry) was born in 1740, in Pilling Lancashire. She is no longer living.  
John Atkinson<sup>259</sup> married Mary Whiteside. They had one son:  
William Atkinson<sup>240</sup> in 1769  
*This family is shown within family tree 76.*
261. JOSHUA MARSDEN (Andrew's five-times-great-grandfather<sup>252</sup>, see Maternal Ancestry) was born about 1719, in Standish, Lancashire, England, to Peter Marsden<sup>269</sup> and Anne Robinson<sup>270</sup>, as shown within family tree 77. He died about 1815, aged about 96.
262. MARGARET LYPTROTT (Andrew's five-times-great-grandmother<sup>253</sup>, see Maternal Ancestry) was born on 18 July 1742, in Standish, Lancashire. She died on 22 May 1781, aged 38, in Standish, Lancashire.  
Joshua Marsden<sup>261</sup>, aged about 33, married Margaret Lyptrott, aged 10, on 5 March 1753 in Standish, Lancashire, England. They had one son:  
Peter Marsden<sup>244</sup> in 1758  
*This family is shown within family tree 77.*
263. GEORGE HARWOOD (Andrew's five-times-great-grandfather<sup>254</sup>, see Maternal Ancestry) was born in 1730, in Bolton, Lancashire, England. He died about January 1794, aged about 63, in Blackburn, Lancashire.
264. ALICE TAYLOR (Andrew's five-times-great-grandmother<sup>255</sup>, see Maternal Ancestry) was born in 1725, in Deane, Lancashire. She is no longer living.  
George Harwood<sup>263</sup>, aged about 28, married Alice Taylor, aged about 33, on 2 January 1759 in Deane Parish Church, Bolton, Lancashire. They had six children:  
Ann (Nancy) Harwood<sup>245</sup> in 1759  
Robert Harwood<sup>246</sup> in 1761  
George Harwood<sup>247</sup> in 1766  
John Harwood<sup>248</sup> about 1766  
Alice Harwood<sup>249</sup> about 1776  
John Harwood<sup>250</sup> about 1779  
*This family is shown as family tree 78.*

### **Generation of Six-Times-Great-Grandparents**

265. JAMES JAMESON (Andrew's six-times-great-grandfather<sup>263</sup>, see Paternal Ancestry) was born about 1723, in Wigan Lancashire England. He is no longer living.
266. MARGARET UNKNOWN (Andrew's six-times-great-grandmother<sup>264</sup>, see Paternal Ancestry) was born in 1728, in of Wigan, Lancashire. She died on 6 November 1801, aged about 73, in Standishgate, Wigan, Lancashire.  
James Jameson<sup>265</sup> married Margaret Unknown. They had one son:  
James Jameson<sup>251</sup> in 1743  
*This family is shown within family tree 74.*
267. TIMOTHY ATKINSON (Andrew's six-times-great-grandfather<sup>266</sup>, see Maternal Ancestry) was born in 1711, in St Michael on Wyre, Lancashire, England. He is no longer living.
268. ELIZABETH HIGGINSON (Andrew's six-times-great-grandmother<sup>267</sup>, see Maternal Ancestry) was born in 1715, in Pilling Lancashire. She is no longer living.  
Timothy Atkinson<sup>267</sup> married Elizabeth Higginson. They had one son:  
John Atkinson<sup>259</sup> in 1739  
*This family is shown within family tree 76.*
269. PETER MARSDEN (Andrew's six-times-great-grandfather<sup>268</sup>, see Maternal Ancestry) was born about 1692, in Standish, Lancashire, England. He died in 1765, aged about 73, in Standish, Lancashire, England.

270. ANNE ROBINSON (Andrew's six-times-great-grandmother<sup>269</sup>, see Maternal Ancestry) was born about 1695, in Standish, Lancashire, England. She died in May 1750, aged about 54, in Standish, Lancashire, England.  
Peter Marsden<sup>269</sup>, aged about 24, married Anne Robinson, aged about 21, on 23 April 1717 in Wigan, All Saints, Lancashire, England. They had one son:  
Joshua Marsden<sup>261</sup> about 1719  
*This family is shown within family tree 77.*

**6. FAMILY TREES**

1. SLACK, Michael Lee and WATTS, Rachel Jane
2. MANU, Richard and EMERSON, Catherine Jane
3. BAIRD-FRASER, Adam and VICKERS, Linda Charlotte
4. WARDLE, Robin Marcus and STONE, Elizabeth J
5. WARDLE, Timothy James and THORNES, Jacqueline A
6. SOMERSALL, James Richard and ANDERSON, Paula Elizabeth
7. BROWN, Martin and FAN, Ximeng Lucy
8. BROWN, Christopher and STOBBE, Megan
9. JAMESON, Andrew John and WHITEHURST, Judith Anne
10. JAMESON, Andrew John and WOODS, Jane Elizabeth
11. JAMESON, Andrew John and EMERSON, Sally
12. WOODS, Jane Elizabeth
13. CAMBLOR, César and JAMESON, Linda Jane
14. VICKERS, William Leslie and JAMESON, Kathryn Mary
15. WARDLE, Roy and JAMESON, Margaret
16. SOMERSALL, Mel and JAMESON, Susan D
17. JABLONSKI, John E and WARMINGTON, Catherine R
18. O'MARA, Paul Thomas and JABLONSKI, Edwina M
19. MCLAREN, Neil and JABLONSKI, Janina M A
20. JABLONSKI, Dennis C and SLATER, Laura E
21. JABLONSKI, Andrew P and CRAWLEY, Anne J
22. BOOTH, Philip and JAMESON, Sheila Anne
23. POTTS, David A B and JAMESON, Angela Ruth
24. BAILEY, Stephen and HARWOOD, Carolyn Anne
25. BROWN, Ian J and HARWOOD, Judith
26. ROOCROFT, Simon A and THORNLEY, Beverley J
27. JAMESON, Robert Bryan and ROOCROFT, Mary Atkinson
28. JAMESON, John Corris and GARDINER, Sarah
29. JABLONSKI, Janik and JAMESON, Brenda
30. JAMESON, Donald Templeman and SANDERSON, Sheila
31. ROOCROFT, John Marsden and HADDOCK, Joan
32. HARWOOD, Leslie James and WOOD, Margaret Linda
33. WOOD, John Derek and BIBBY, Barbara E
34. ROOCROFT, David Ewart and BROCK, Irene Elizabeth McDonald
35. JAMESON, Edward Corris and TEMPLEMAN, Emma
36. ROOCROFT, James and ATKINSON, Dora Marsden
37. SELLEN, George O A and JAMESON, Amelia Ann
38. TEMPLEMAN, Amos Stimson and SARGEANT, Katherine
39. WAKEFIELD, Albert George and TEMPLEMAN, Louisa (Kate) Catherine
40. TEMPLEMAN, Edith
41. JONES, Charles Watkin and ROOCROFT, Alice
42. CAMPBELL, Herbert and ROOCROFT, Ethel
43. WOOD, Ernest Croft and ATKINSON, Linda Marsden
44. ROOCROFT, Eric Talbot and KING, Aileen Mary
45. WILKINSON, Bert and MARSDEN, Cissie
46. MARSDEN, Thomas and PENDLEBURY, Lucy
47. LOMAX, John Thomas and MARSDEN, Mary (Polly) Elizabeth
48. LORD, Albert and MARSDEN, Elsie
49. JAMESON, John and CORRIS, Mary Elizabeth
50. TEMPLEMAN, Thomas and COBB, Jane
51. ROOCROFT, Robert and BEST, Elizabeth Evelyne
52. ATKINSON, John and MARSDEN, Mary Ellen
53. ROOCROFT, William and TALBOT, Clara
54. MARSDEN, Robert and WILKINSON, Martha
55. MARSDEN, Robert
56. MARSDEN, Richard (Dick) and WOODWARD, Amy Ann
57. JAMESON, William and ARROWSMITH, Elizabeth
58. CORRIS, Edward and HARRISON, Jane
59. TEMPLEMAN, William and ALLEN, Ann
60. COBB, Amos and STIMSON, Jane
61. ROOCROFT, Edward and BATTY, Mary
62. ATKINSON, James and HODSON, Jane
63. LOFTHOUSE, Matthew and HODSON, Jane
64. MARSDEN, Thomas and BOLTON, Elizabeth (Betty)
65. PEASGOOD, Mr. and STIMSON, Ann

66. STIMSON, John and POSNETTE, Sarah
67. JAMESON, Peter and HADKIN, Frances (Fanny)
68. CORRIS, Simon and COWIN, Elizabeth
69. STIMSON, William and LATTIMORE, Catherine
70. ROOCROFT, Richard and ATKINSON, Catherine Charlotte
71. ATKINSON, Christopher and WRIGHT, Mary
72. MARSDEN, Robert and BIBBY, Mary
73. BOLTON, John and MORRIS, Sarah
74. GASKELL, William and JAMESON, Margaret
75. JAMESON, Margaret
76. ATKINSON, William and SUMMERS, Isabella
77. MARSDEN, Peter and HARWOOD, Ann (Nancy)
78. HARWOOD, George and TAYLOR, Alice

**1. Michael Lee Slack and Rachel Jane Watts**

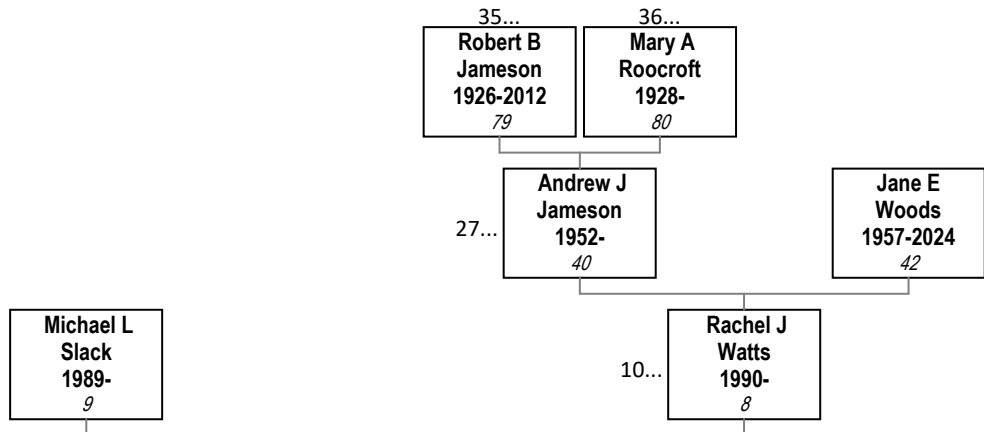

**2. Richard Manu and Catherine Jane Emerson**

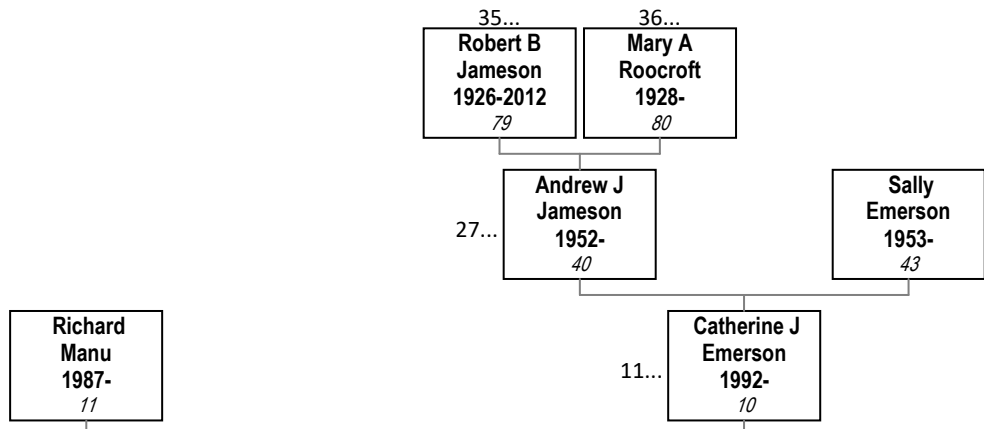

**3. Adam Baird-Fraser and Linda Charlotte Vickers**

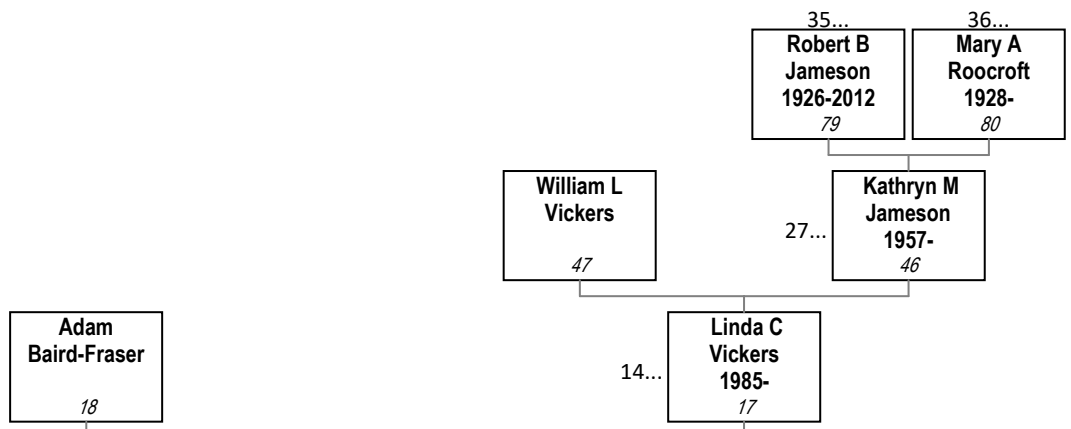

**4. Robin Marcus Wardle and Elizabeth J Stone**

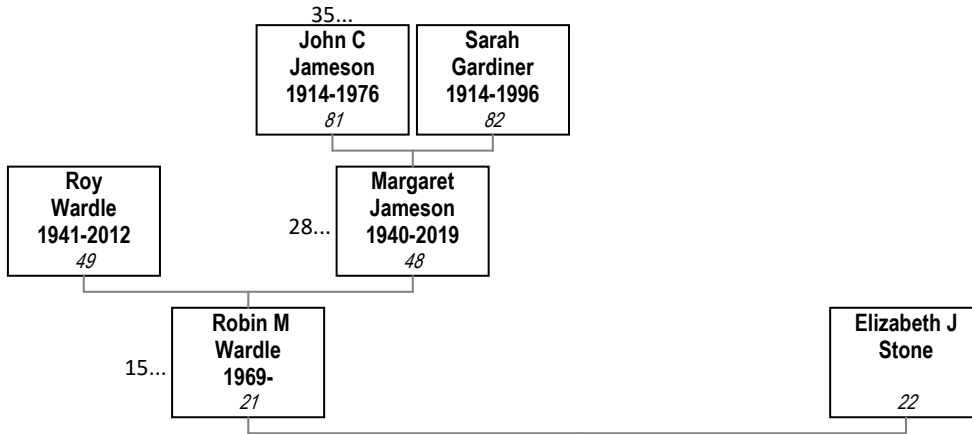

**5. Timothy James Wardle and Jacqueline A Thornes**

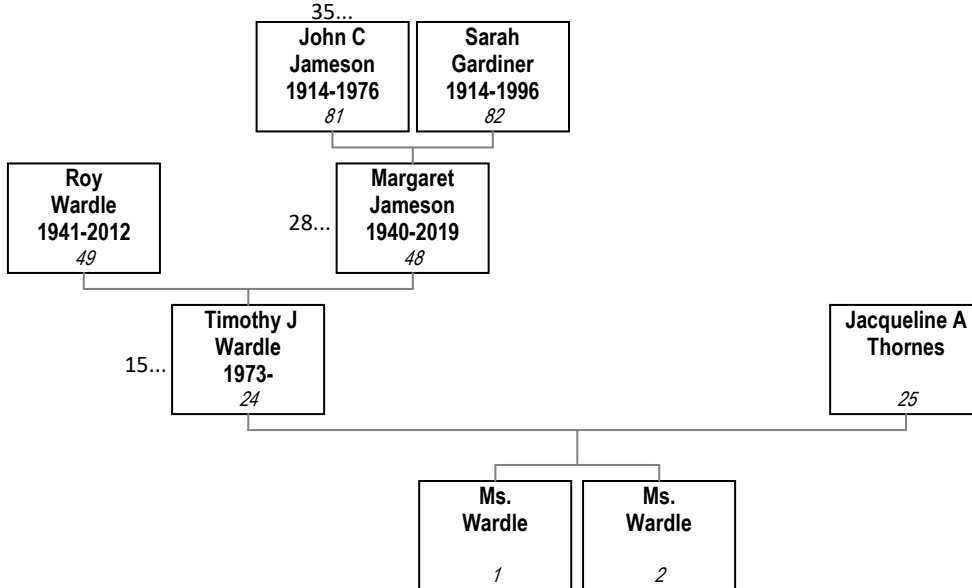

**6. James Richard Somersall and Paula Elizabeth Anderson**

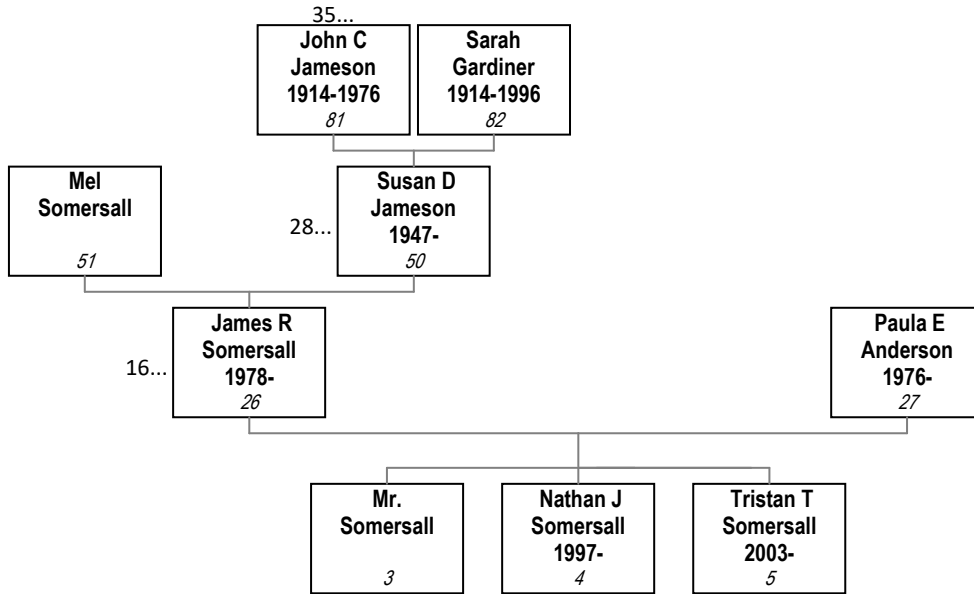

**7. Martin Brown and Ximeng Lucy Fan**

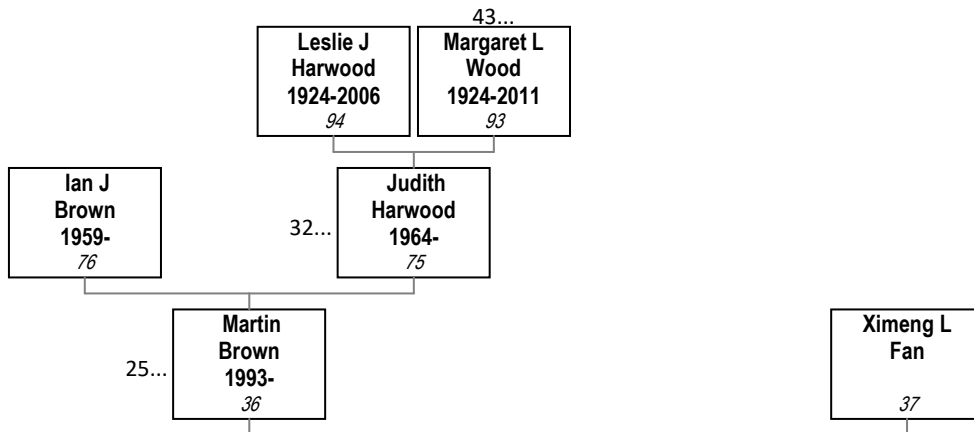

**8. Christopher Brown and Megan Stobbe**

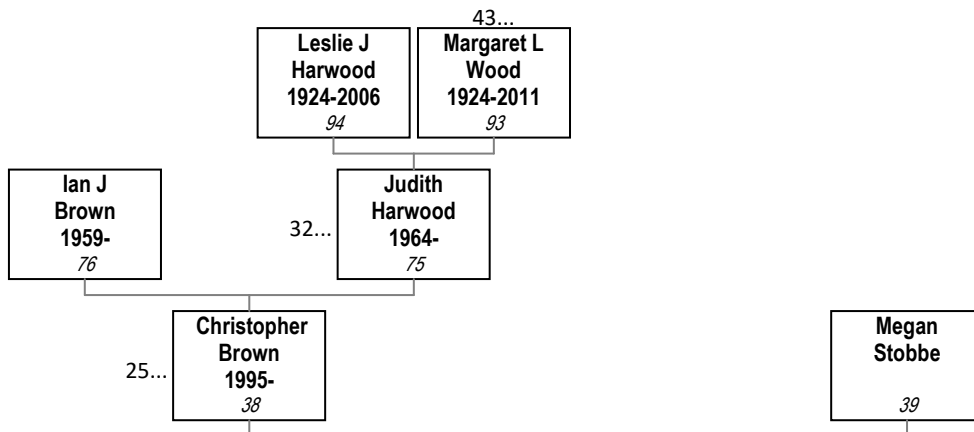

**9. Andrew John Jameson and Judith Anne Whitehurst**

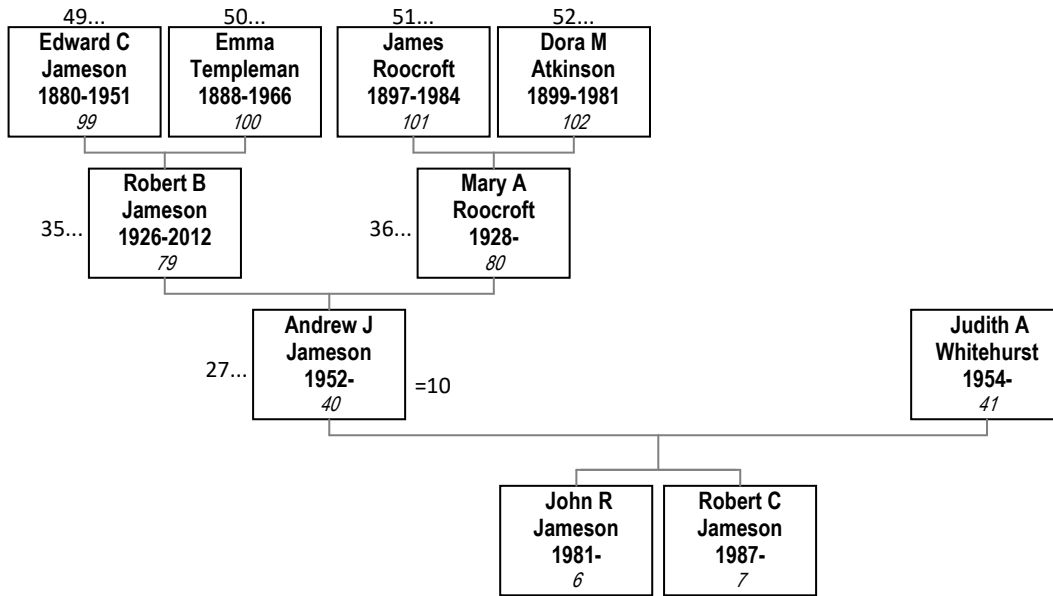

**10. Andrew John Jameson and Jane Elizabeth Woods**

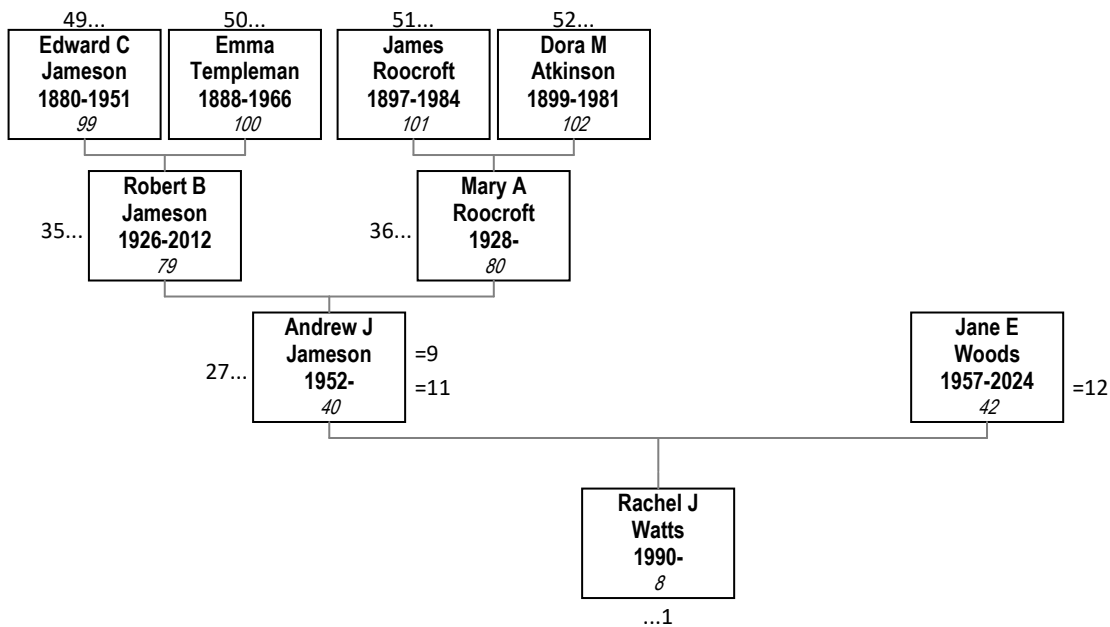

**11. Andrew John Jameson and Sally Emerson**

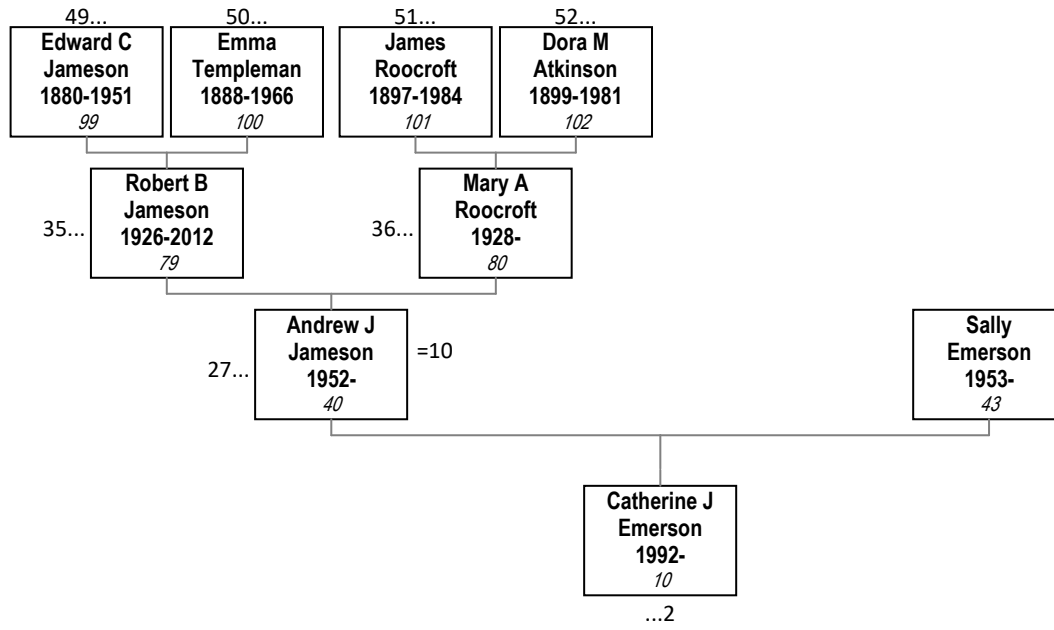

**12. Jane Elizabeth Woods**

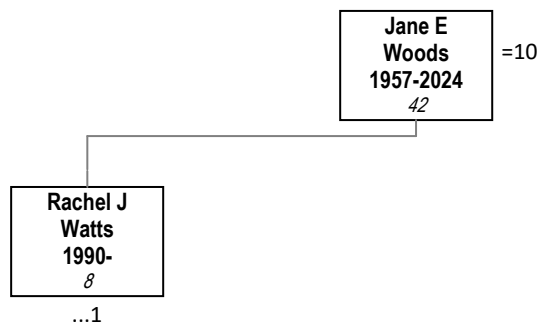

**13. César Camblor and Linda Jane Jameson**

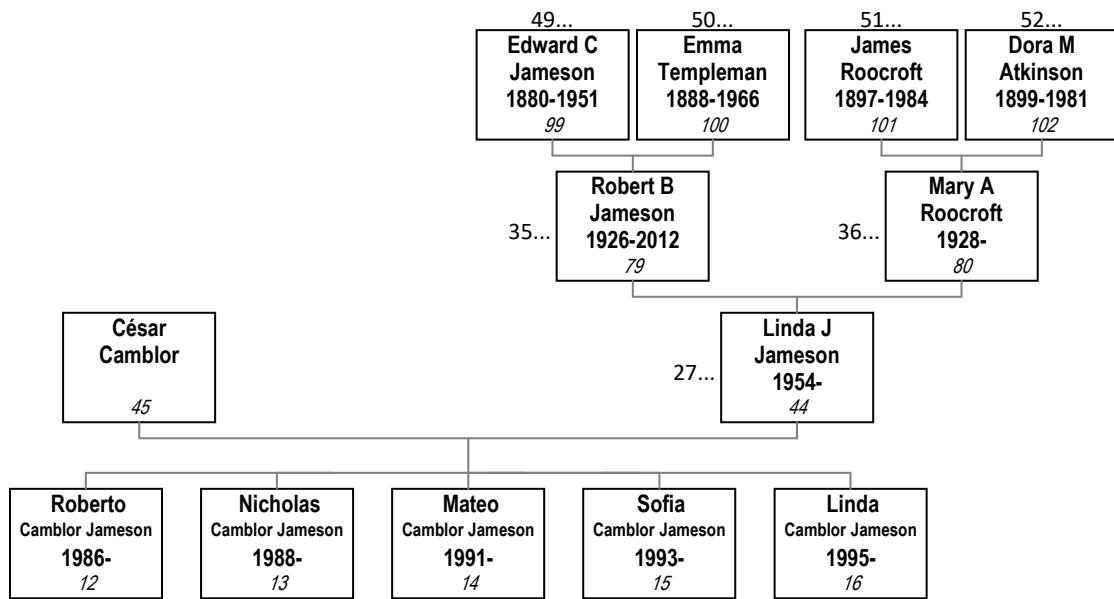

**14. William Leslie Vickers and Kathryn Mary Jameson**

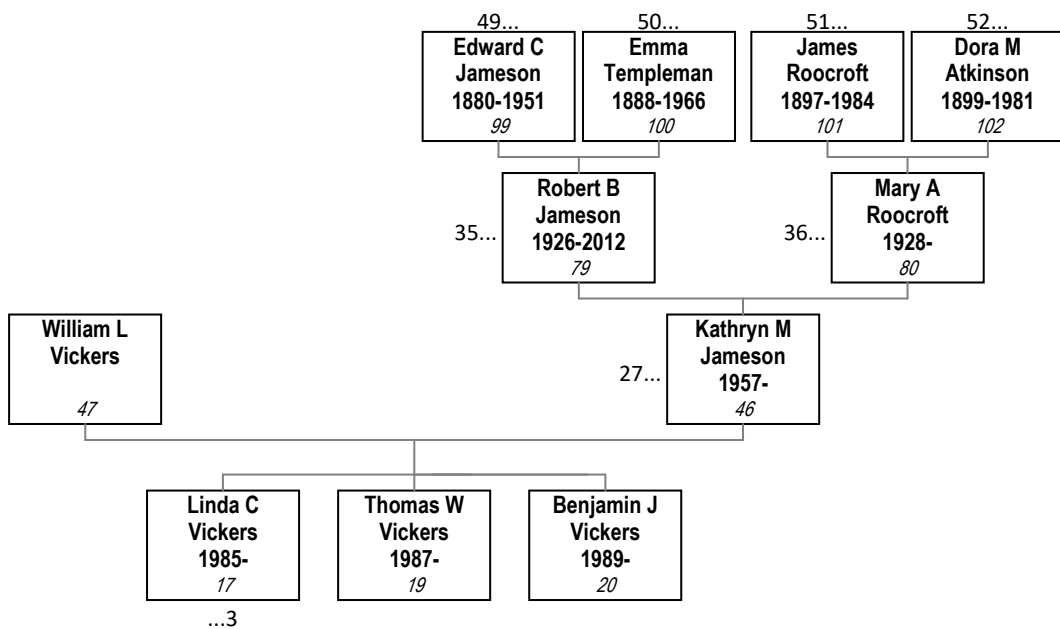

**15. Roy Wardle and Margaret Jameson**

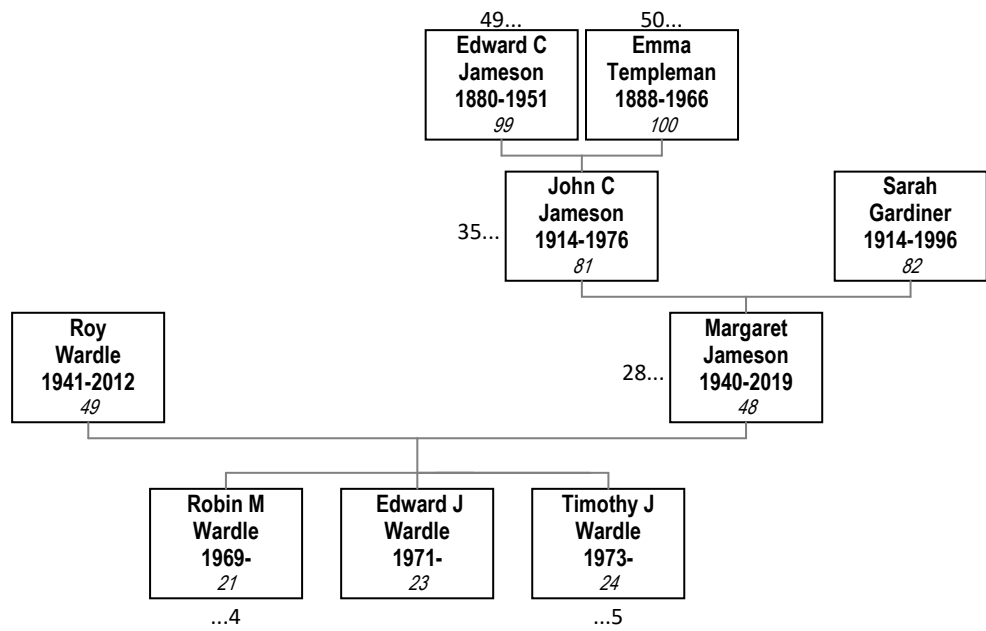

**16. Mel Somersall and Susan D Jameson**

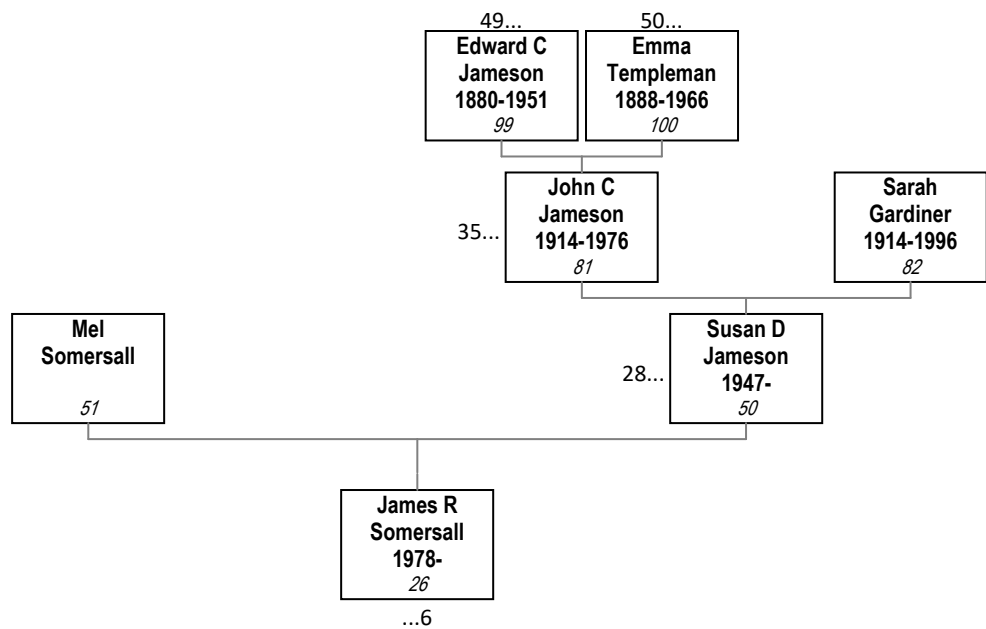

**17. John E Jablonski and Catherine R Warmington**

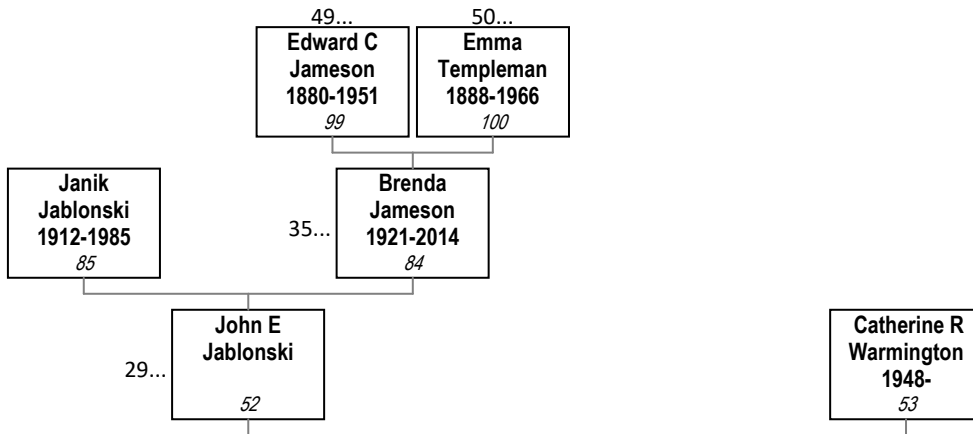

**18. Paul Thomas O'Mara and Edwina M Jablonski**

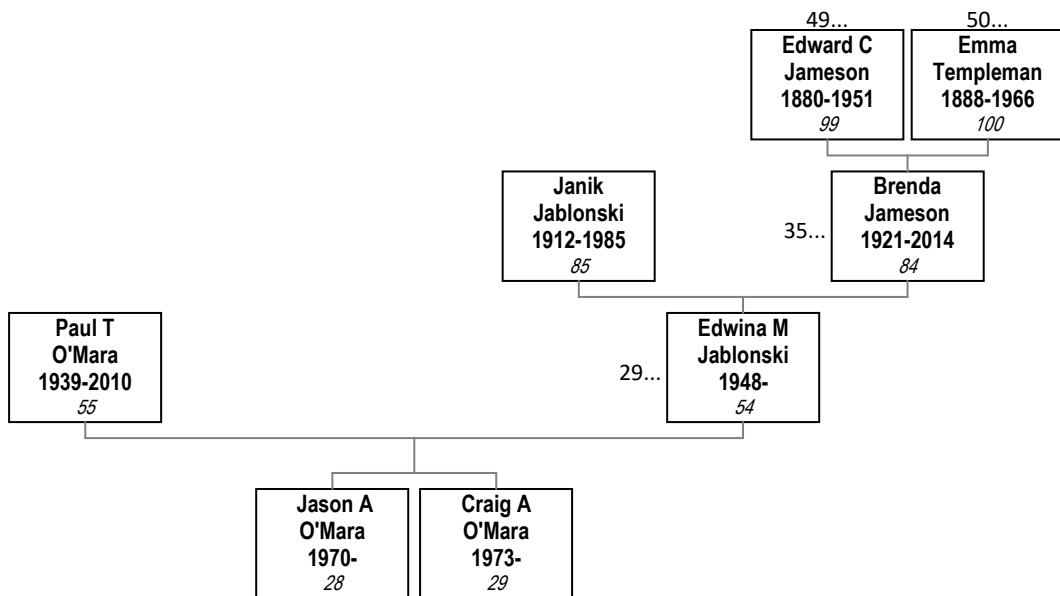

**19. Neil McLaren and Janina M A Jablonski**

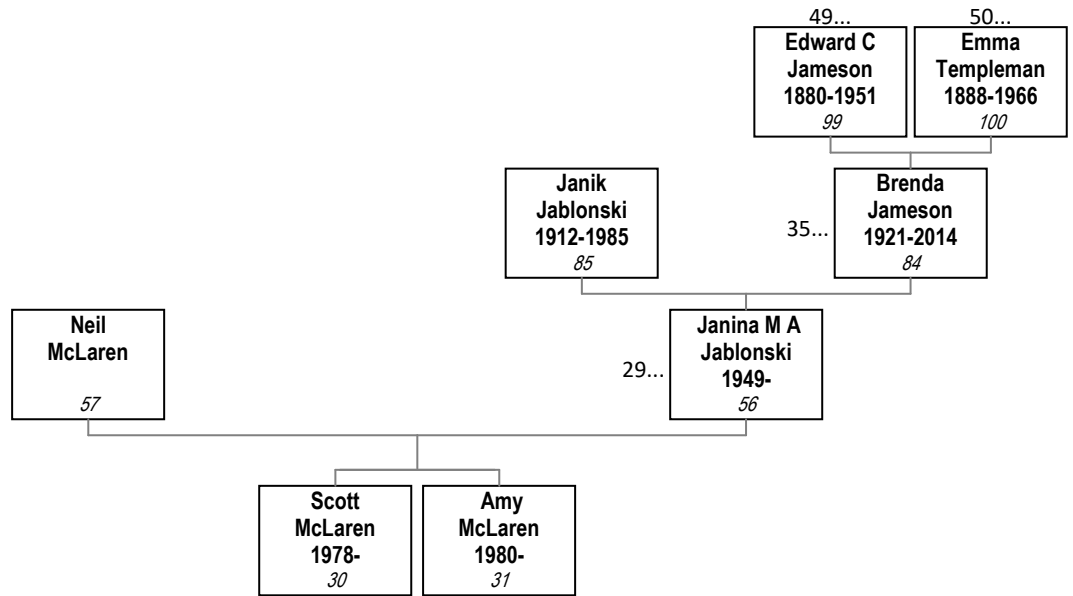

**20. Dennis C Jablonski and Laura E Slater**

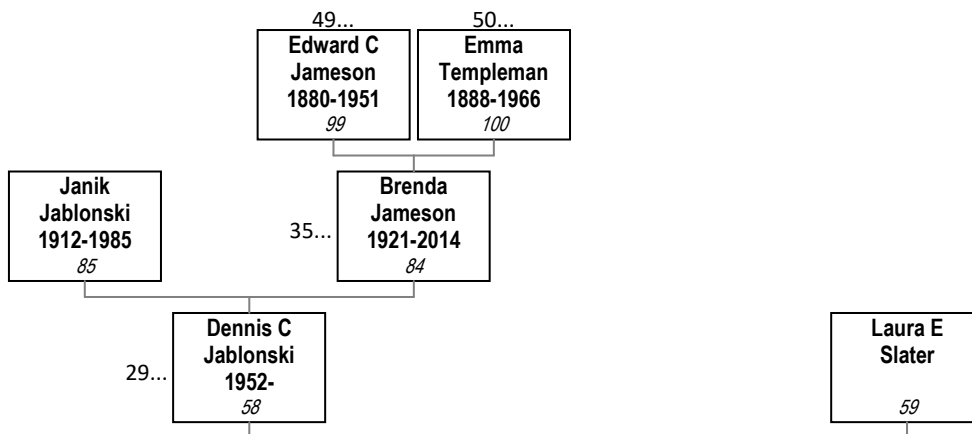

**21. Andrew P Jablonski and Anne J Crawley**

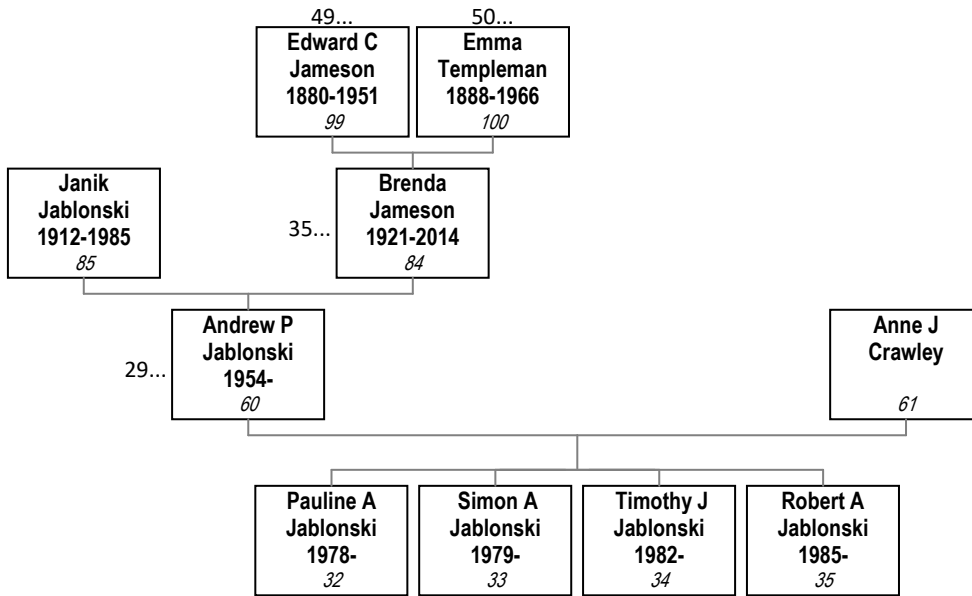

**22. Philip Booth and Sheila Anne Jameson**

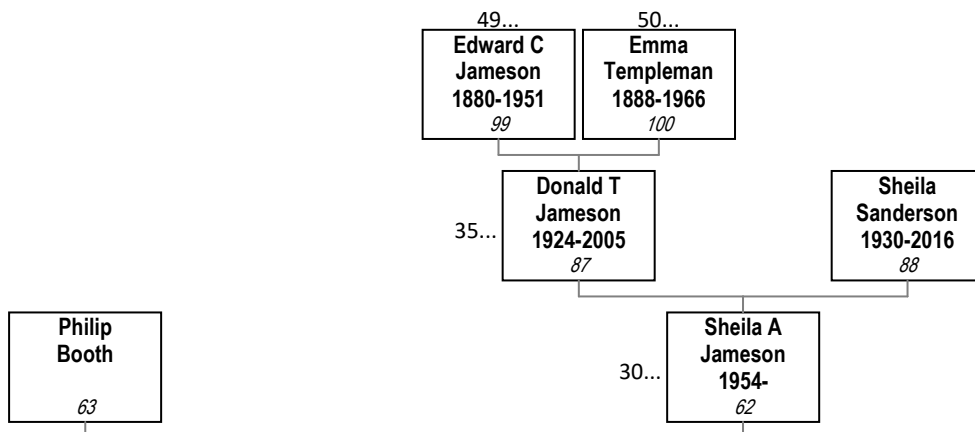

**23. David A B Potts and Angela Ruth Jameson**

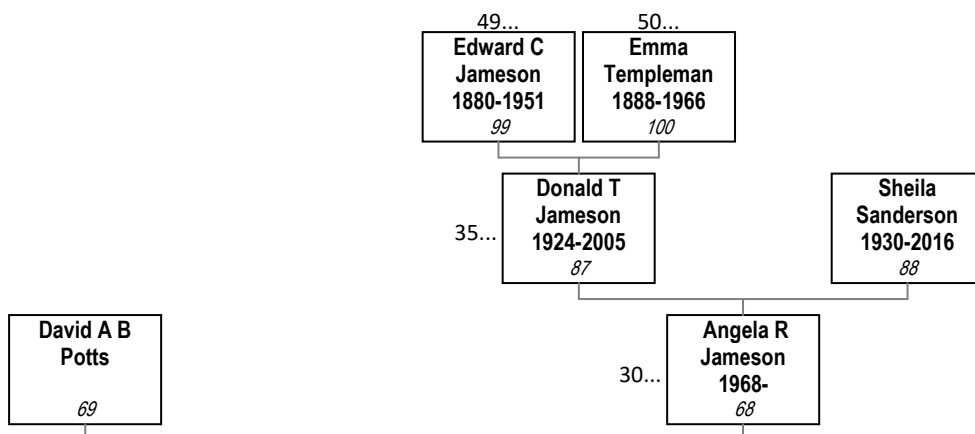

**24. Stephen Bailey and Carolyn Anne Harwood**

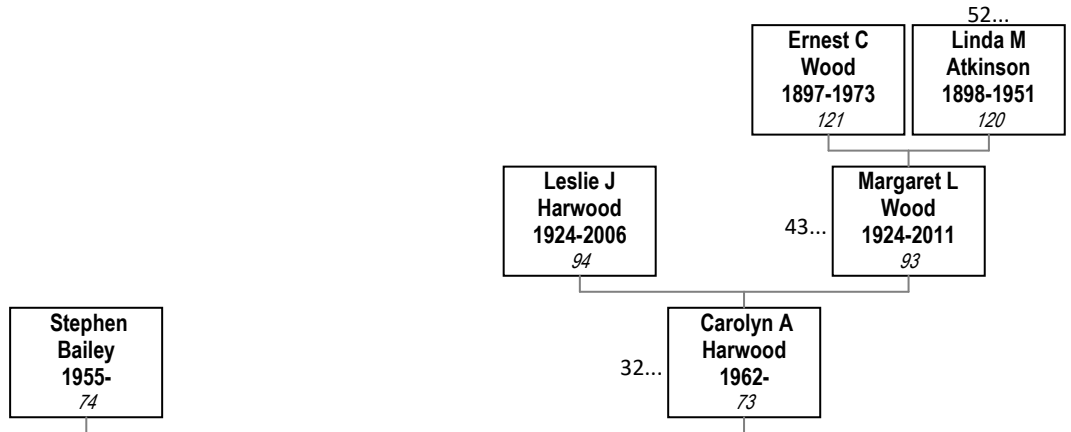

**25. Ian J Brown and Judith Harwood**

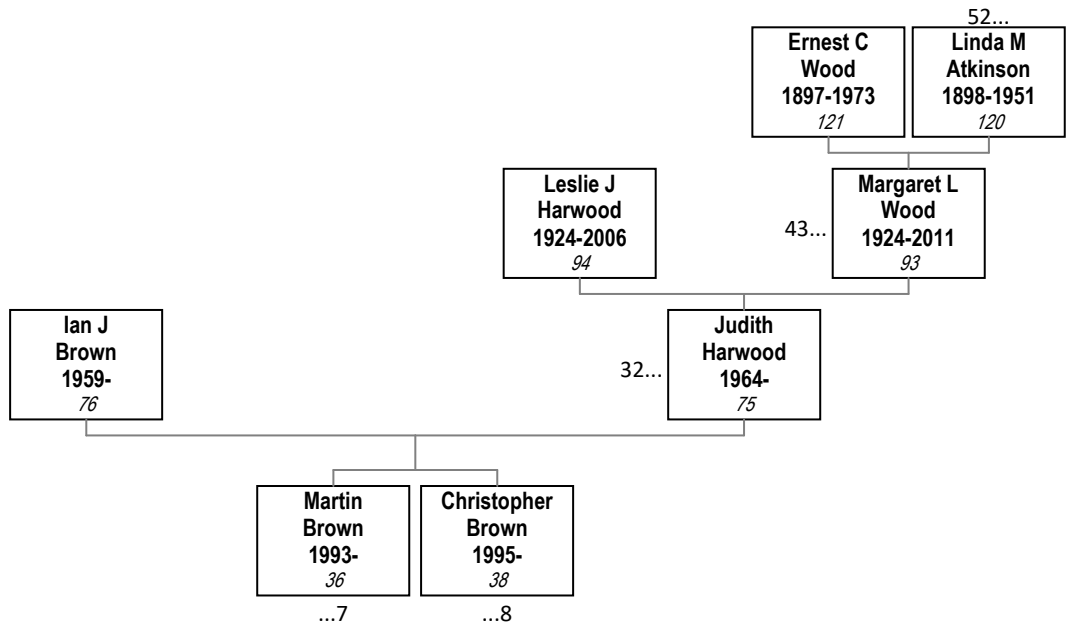

**26. Simon A Roocroft and Beverley J Thornley**

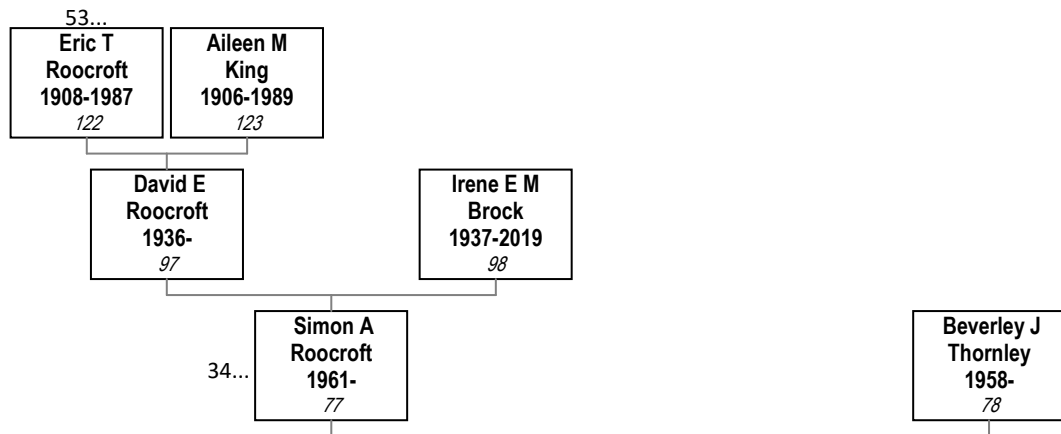

**27. Robert Bryan Jameson and Mary Atkinson Roorcroft**

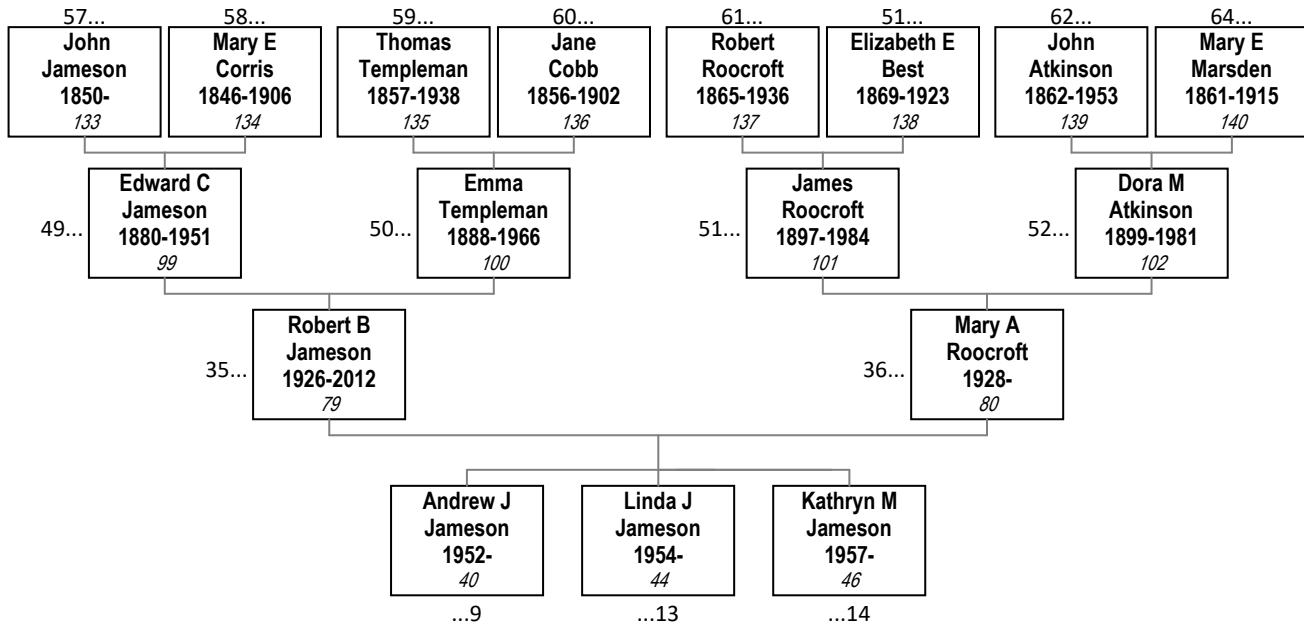

**28. John Corris Jameson and Sarah Gardiner**

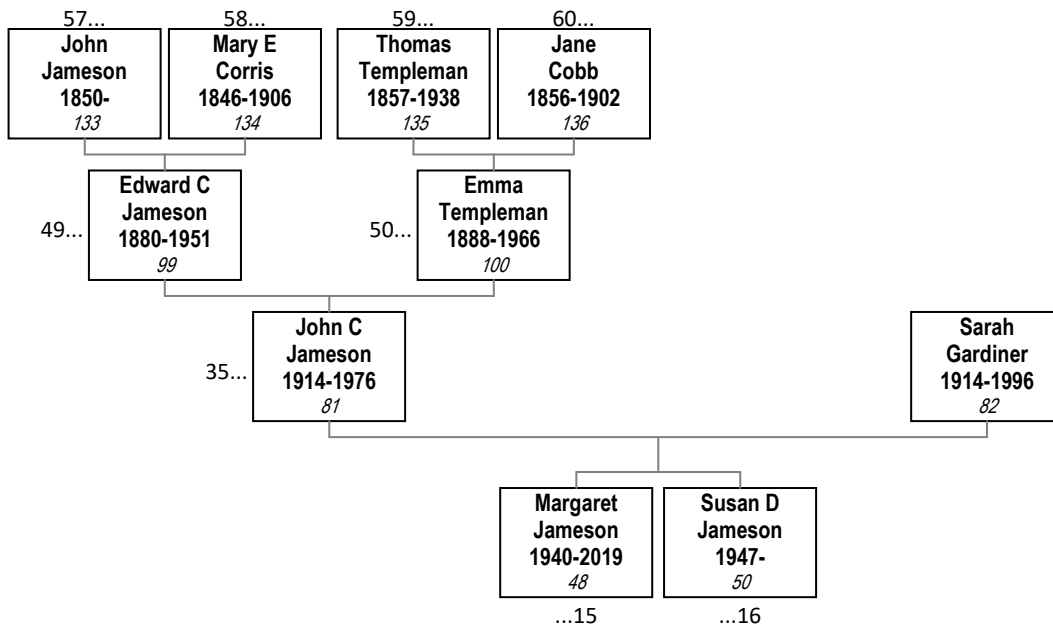

**29. Janik Jablonski and Brenda Jameson**

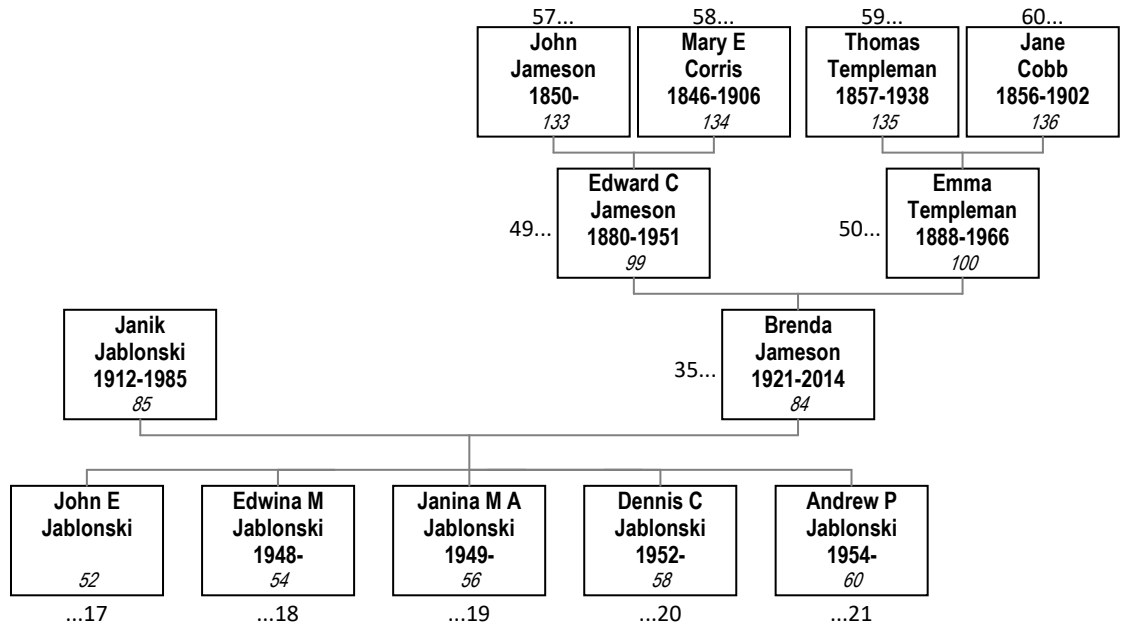

**30. Donald Templeman Jameson and Sheila Sanderson**

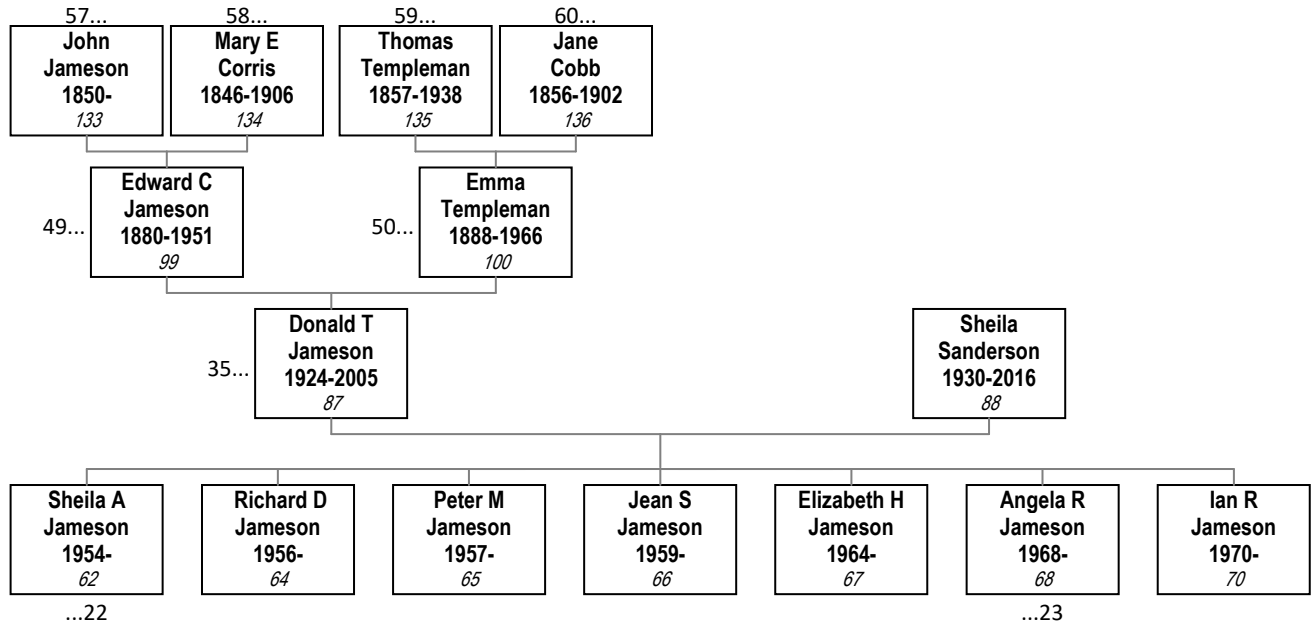

**31. John Marsden Roorcroft and Joan Haddock**

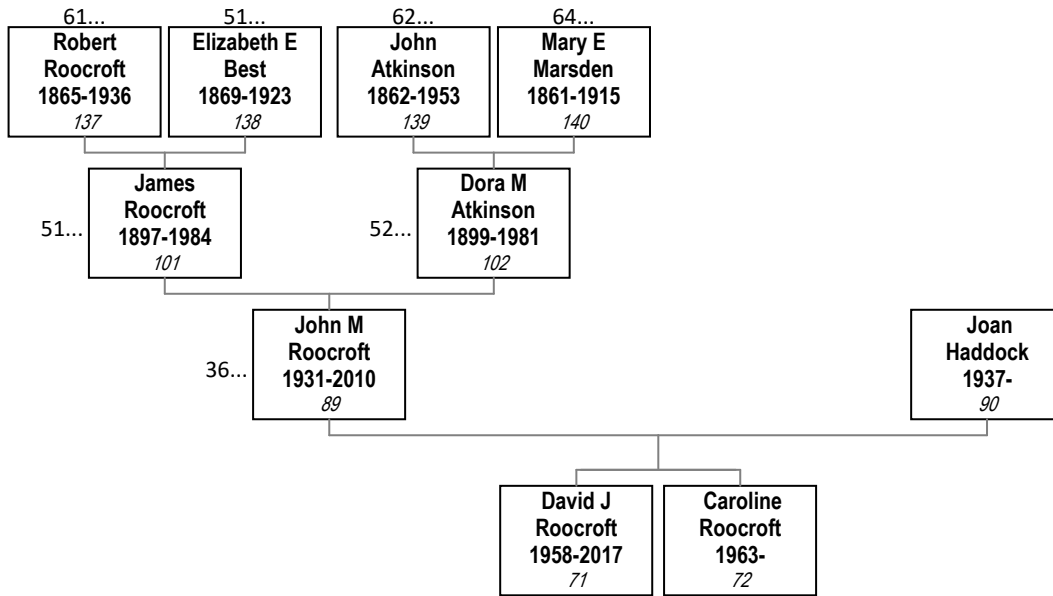

**32. Leslie James Harwood and Margaret Linda Wood**

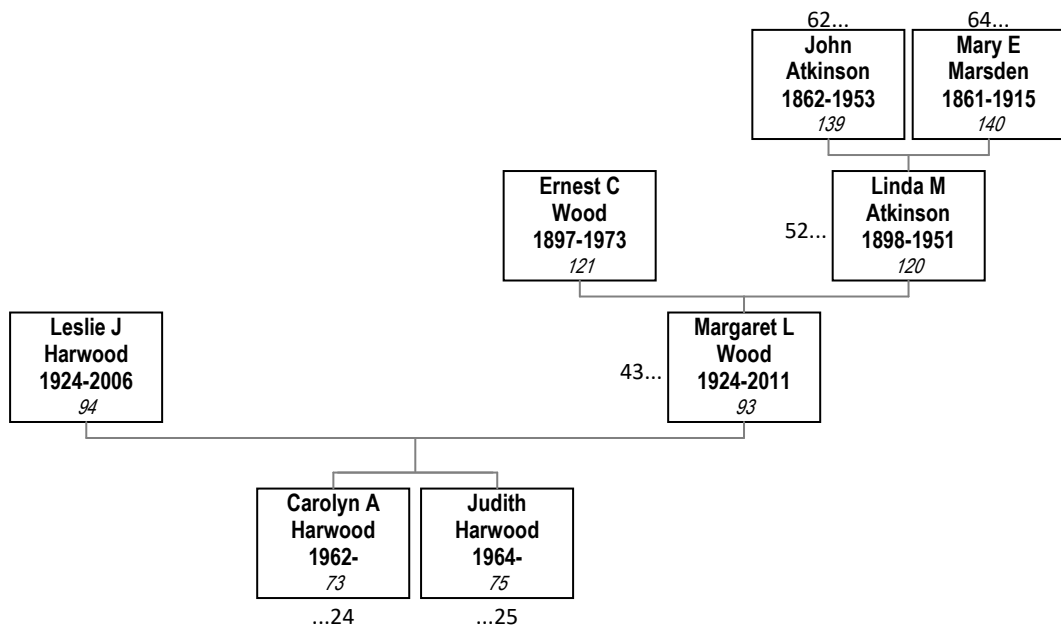

**33. John Derek Wood and Barbara E Bibby**

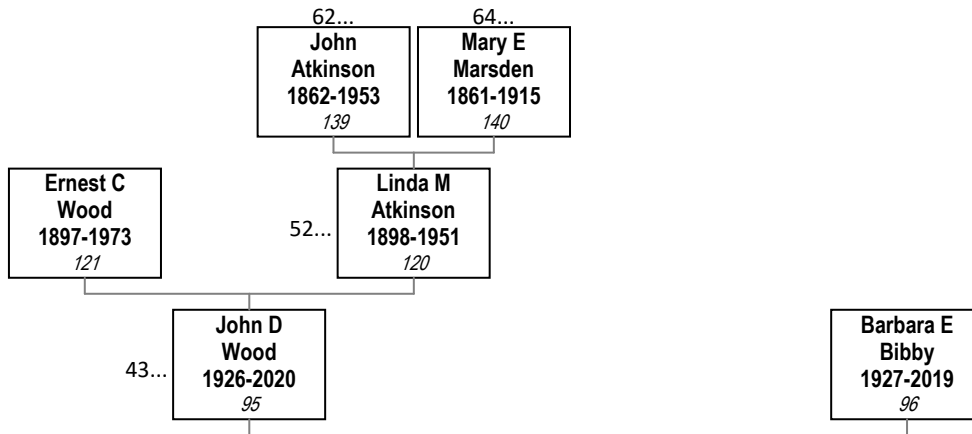

**34. David Ewart Roocroft and Irene Elizabeth McDonald Brock**

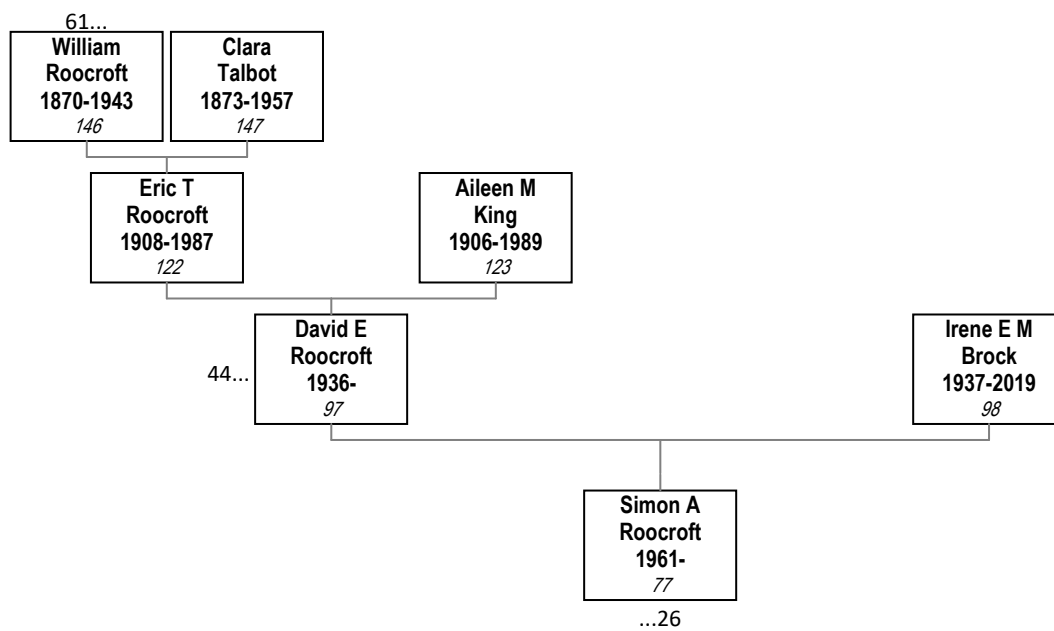

**35. Edward Corris Jameson and Emma Templeman**

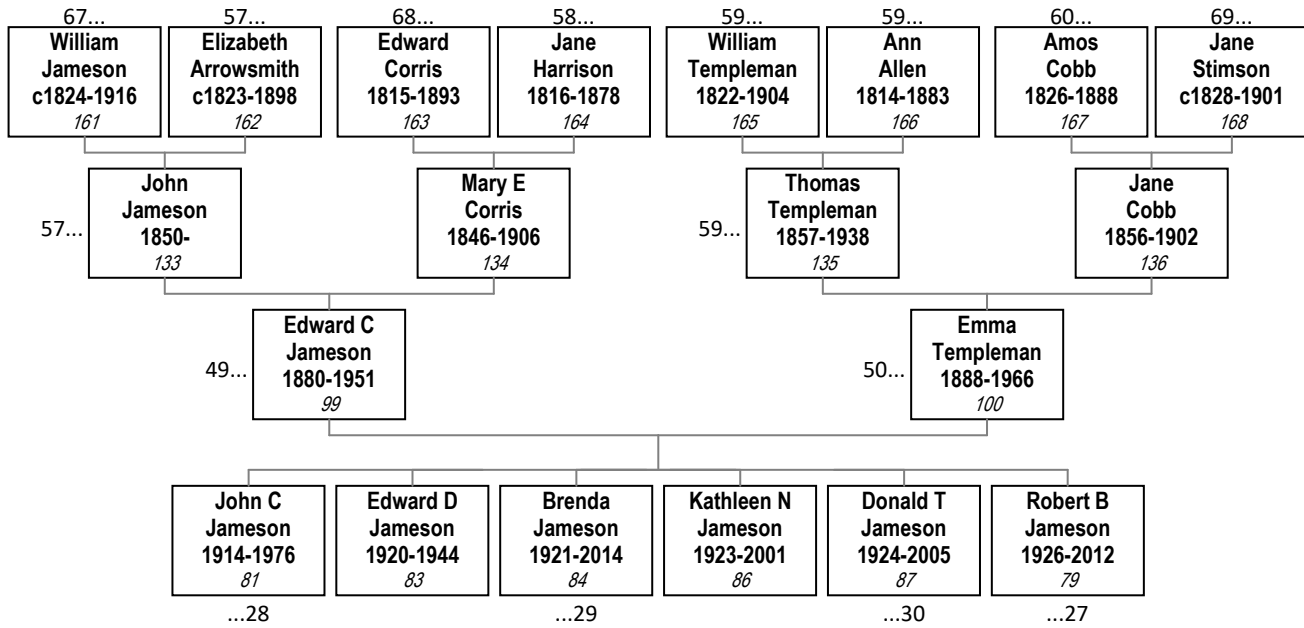

**36. James Roorcroft and Dora Marsden Atkinson**

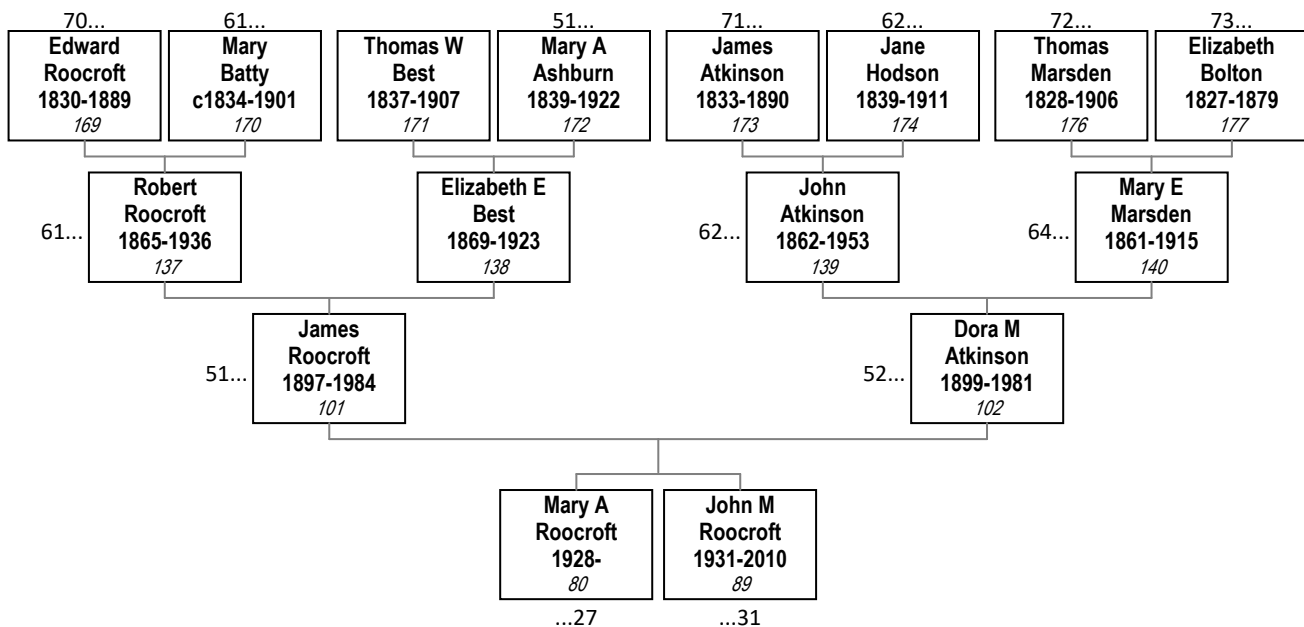

**37. George O A Sellen and Amelia Ann Jameson**

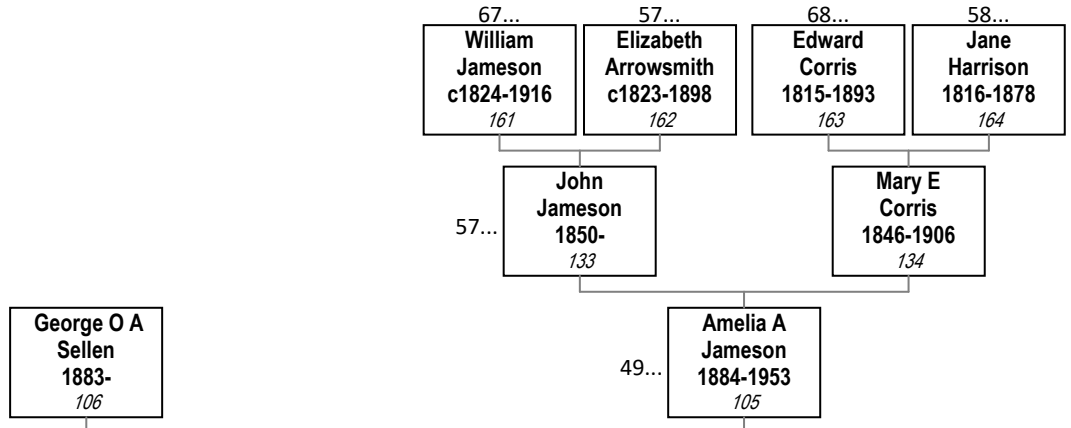

**38. Amos Stimson Templeman and Katherine Sargeant**

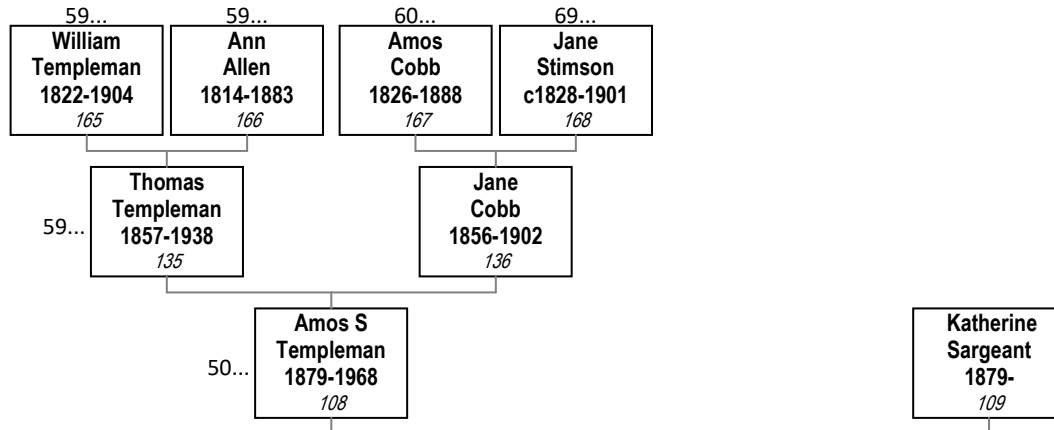

**39. Albert George Wakefield and Louisa (Kate) Catherine Templeman**

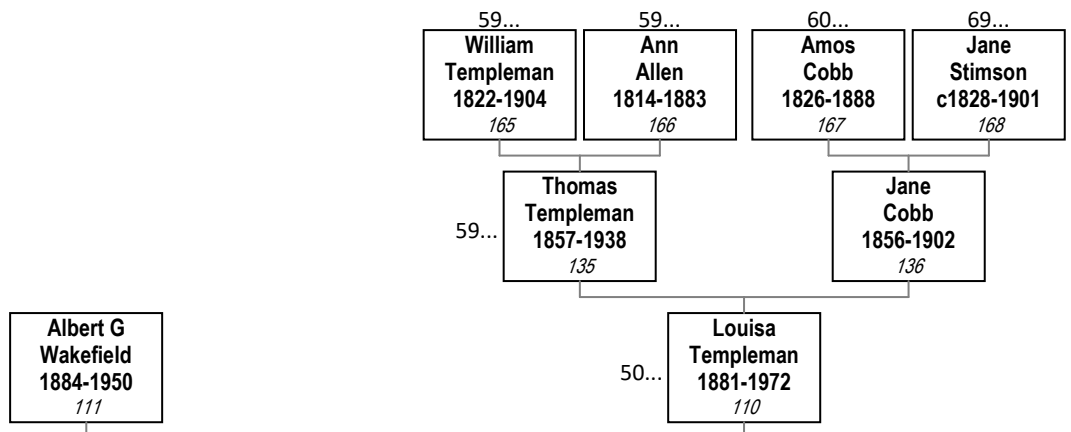

**40. Edith Templeman**

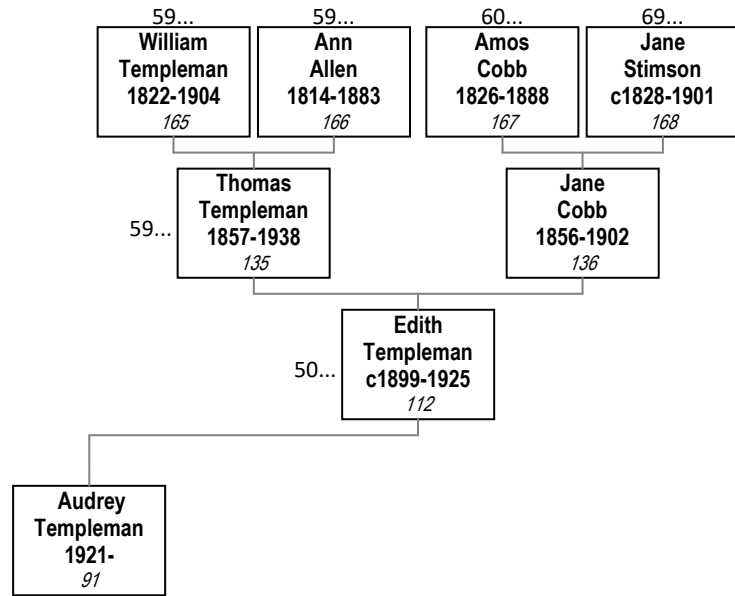

**41. Charles Watkin Jones and Alice Roccroft**

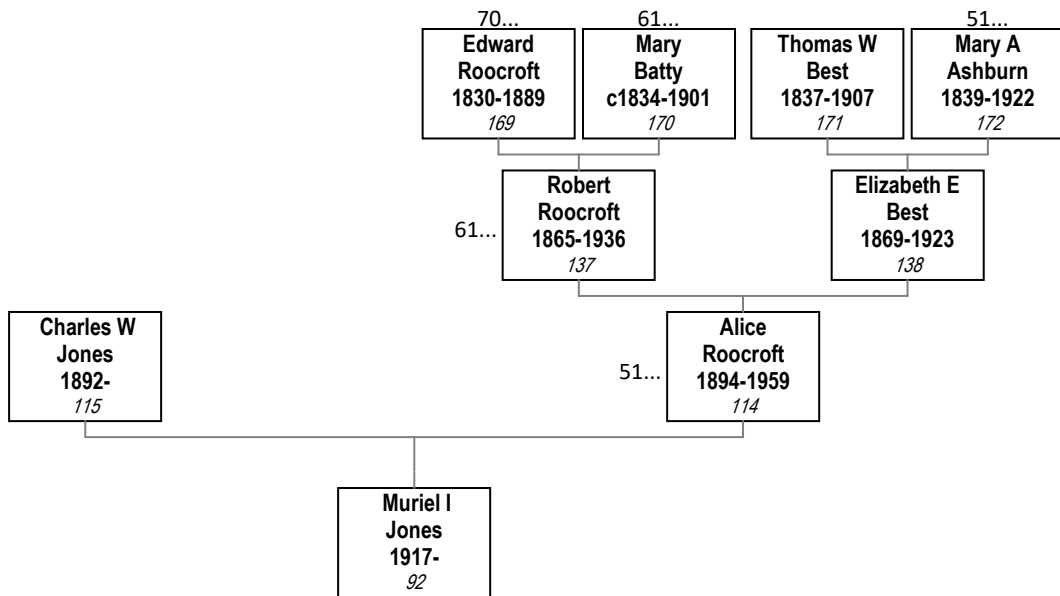

**42. Herbert Campbell and Ethel Roocroft**

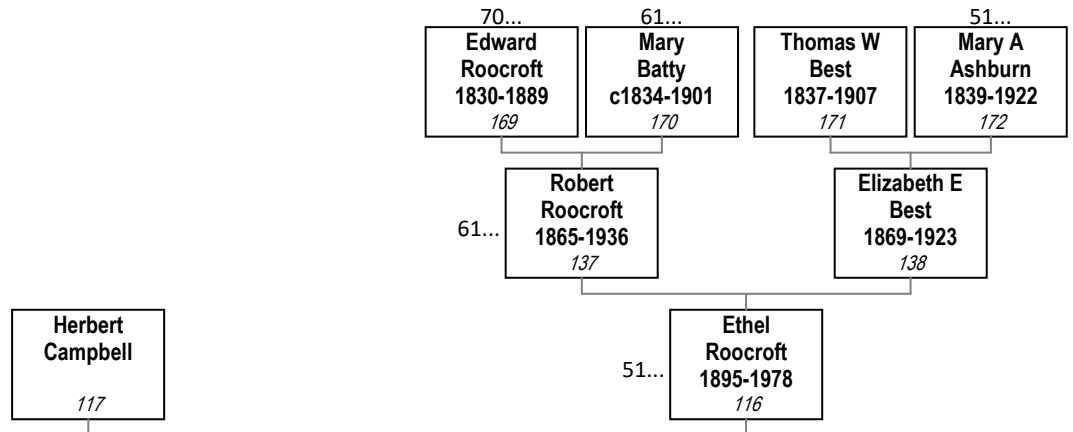

**43. Ernest Croft Wood and Linda Marsden Atkinson**

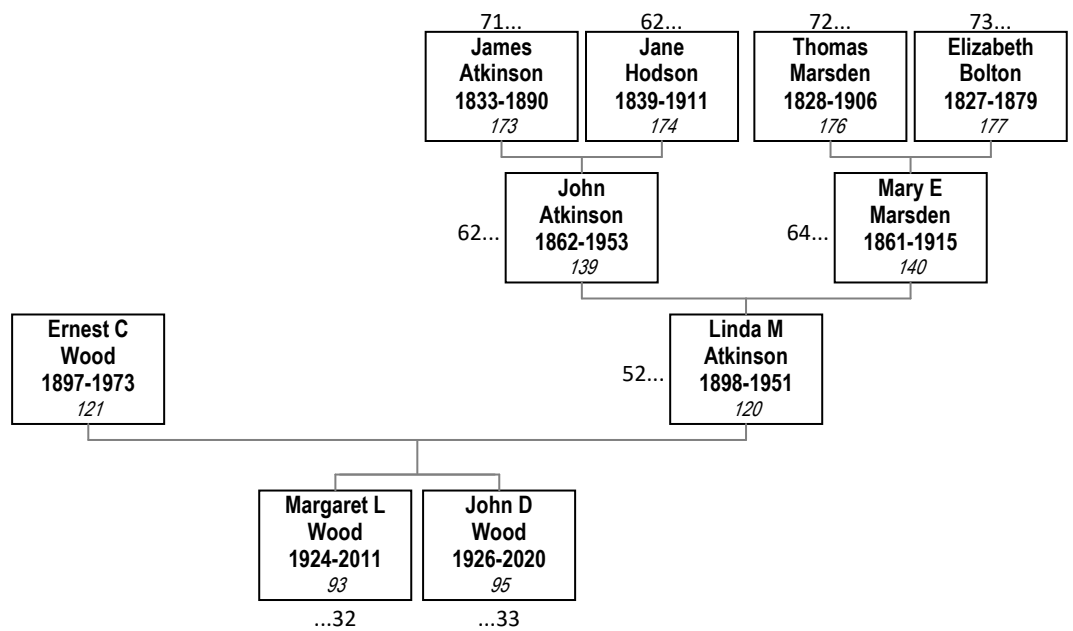

**44. Eric Talbot Roorcroft and Aileen Mary King**

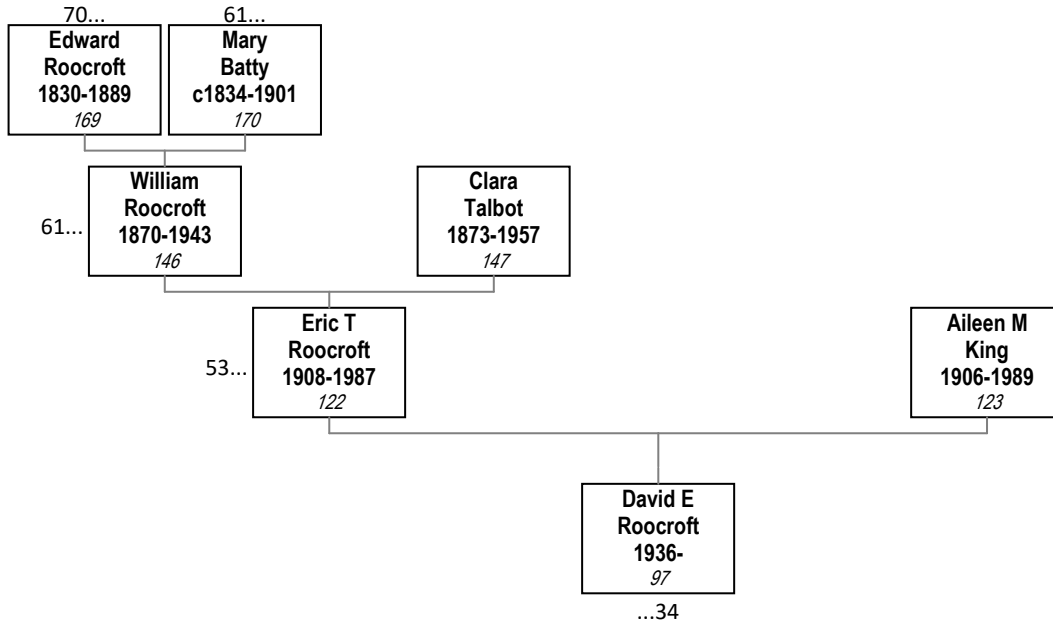

**45. Bert Wilkinson and Cissie Marsden**

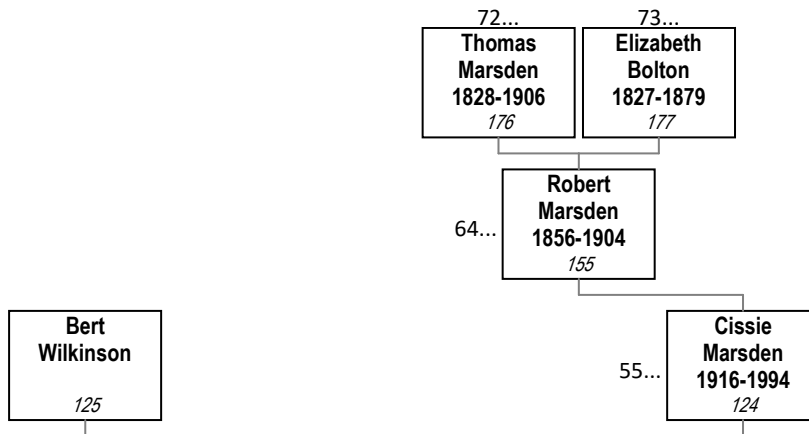

**46. Thomas Marsden and Lucy Pendlebury**

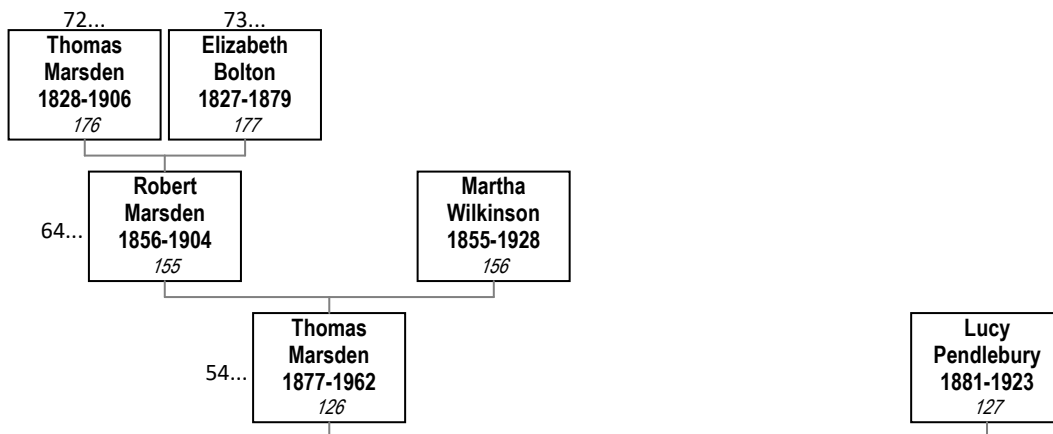

**47. John Thomas Lomax and Mary (Polly) Elizabeth Marsden**

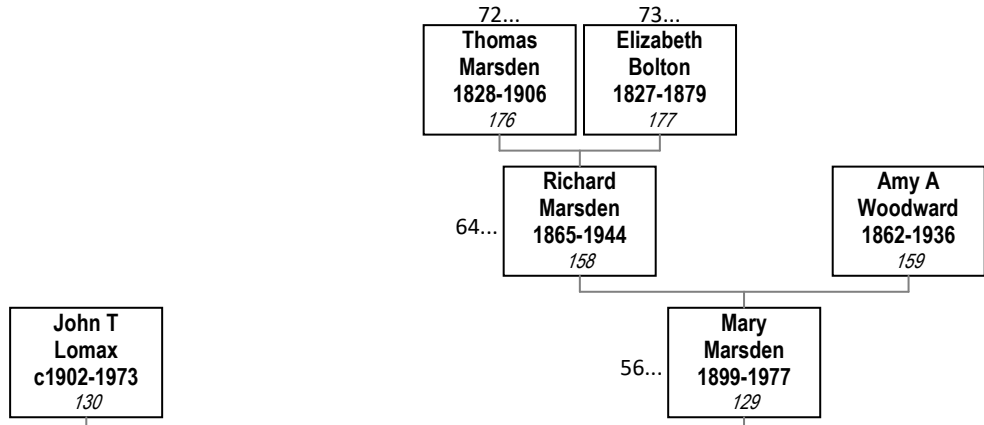

**48. Albert Lord and Elsie Marsden**

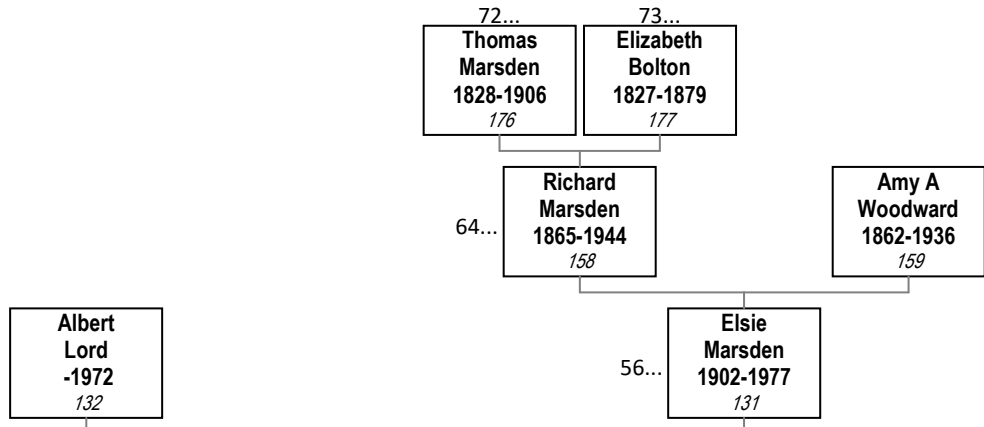

**49. John Jameson and Mary Elizabeth Corris**

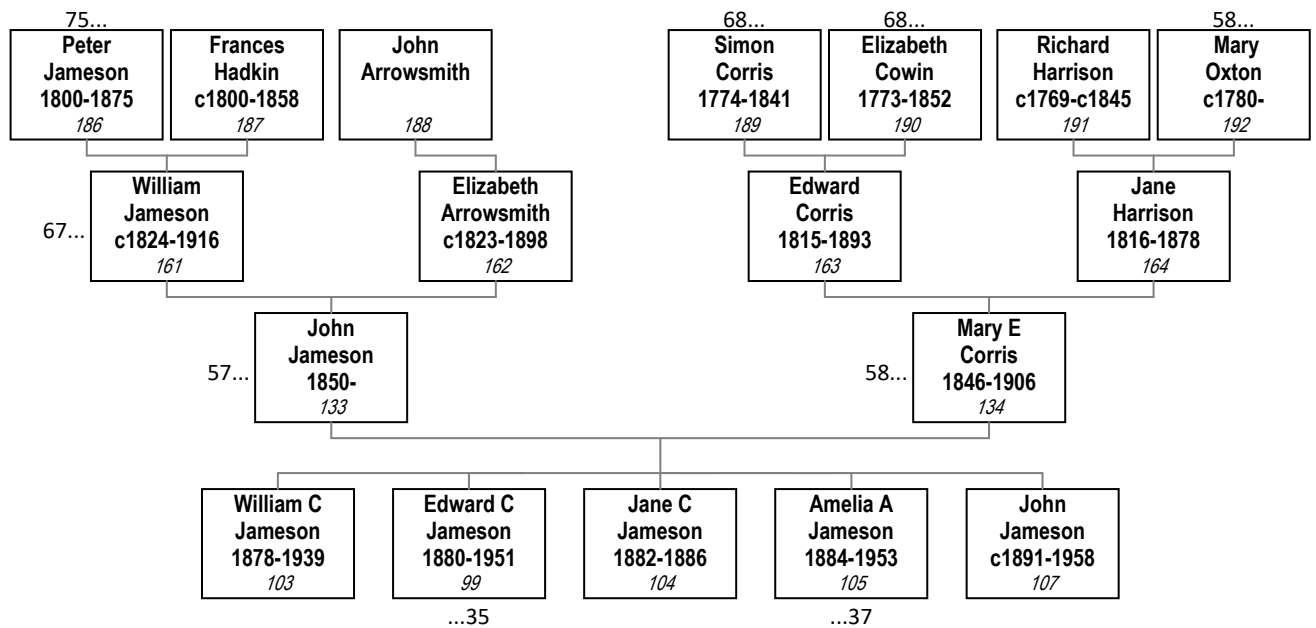

**50. Thomas Templeman and Jane Cobb**

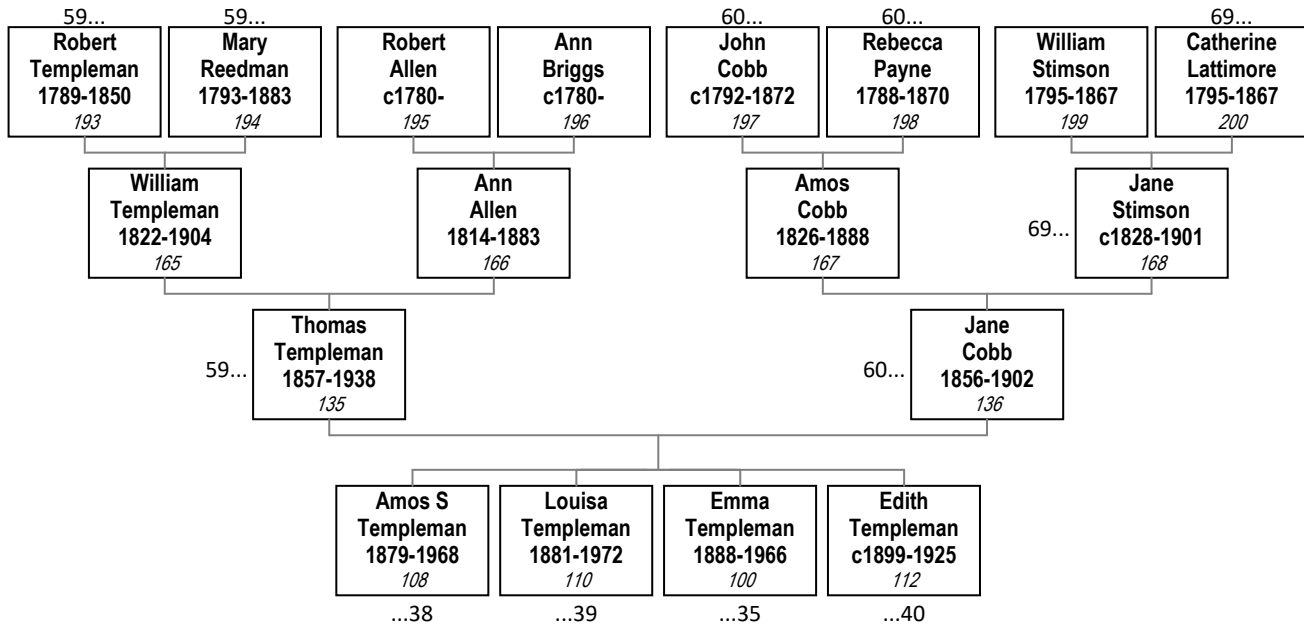

**51. Robert Roocroft and Elizabeth Evelyne Best**

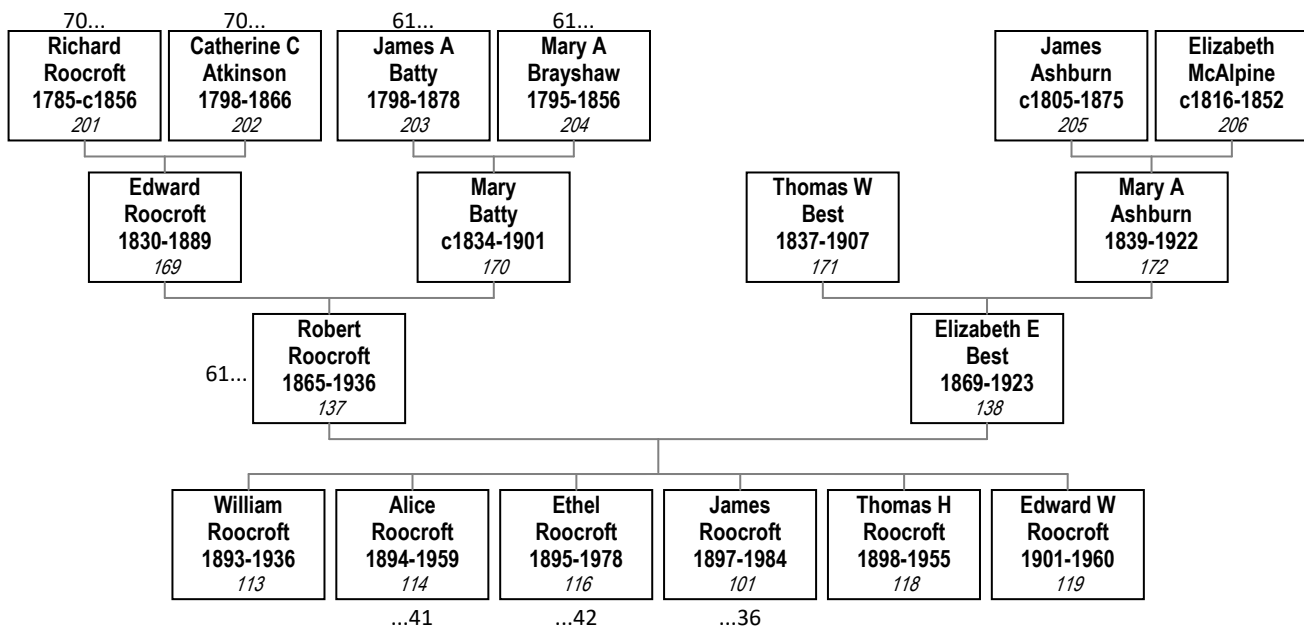

**52. John Atkinson and Mary Ellen Marsden**

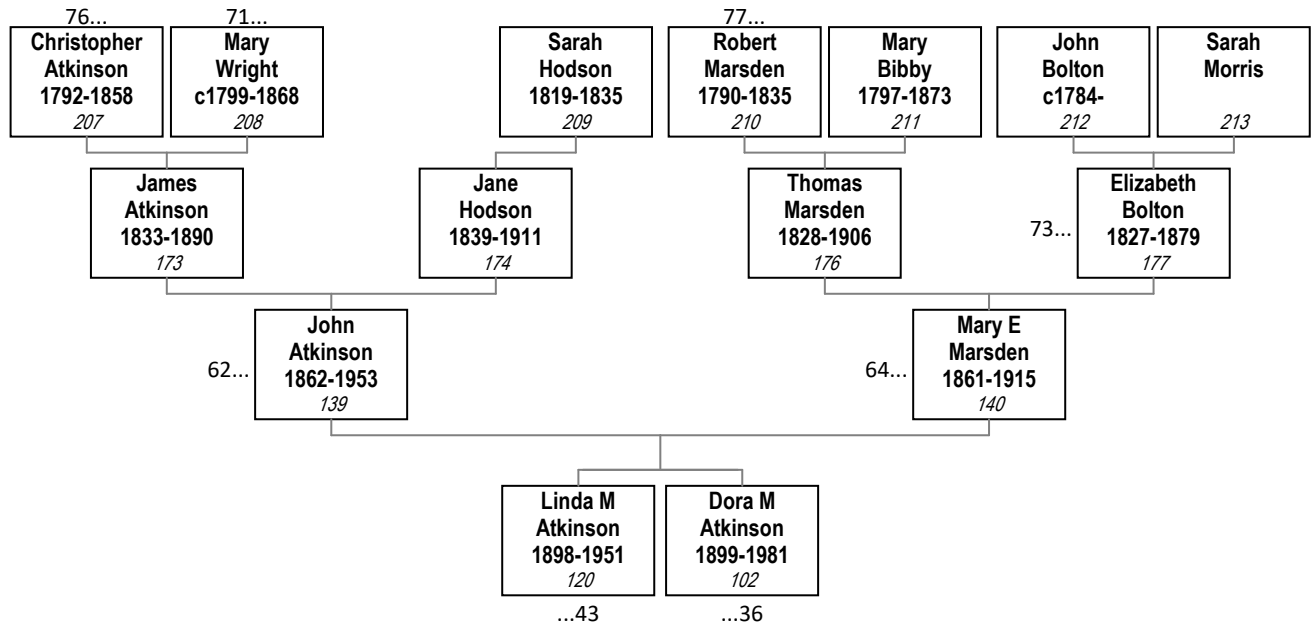

**53. William Roccroft and Clara Talbot**

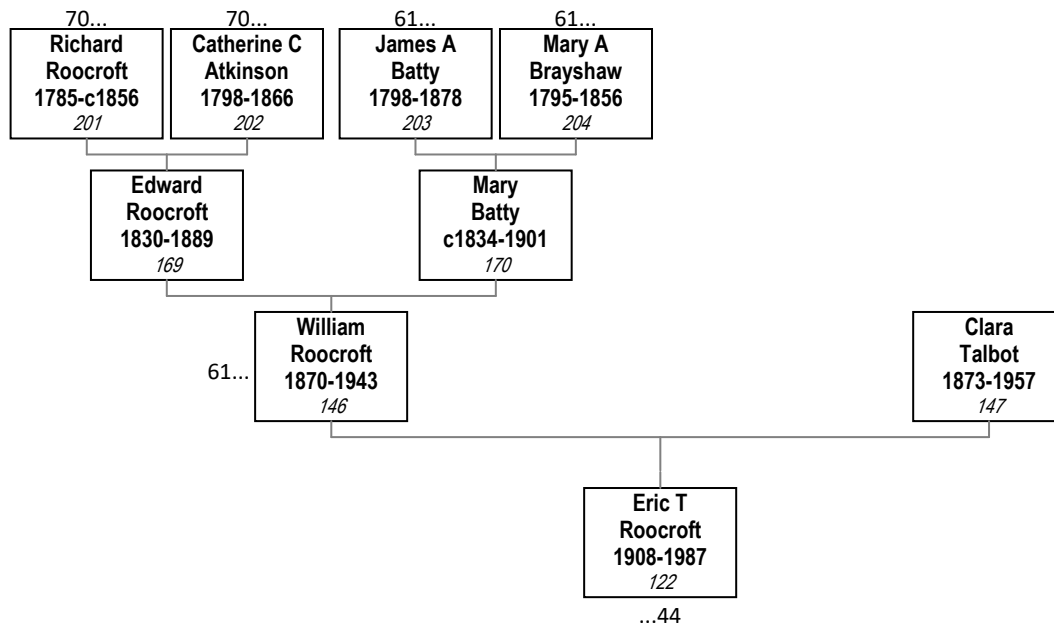

**54. Robert Marsden and Martha Wilkinson**

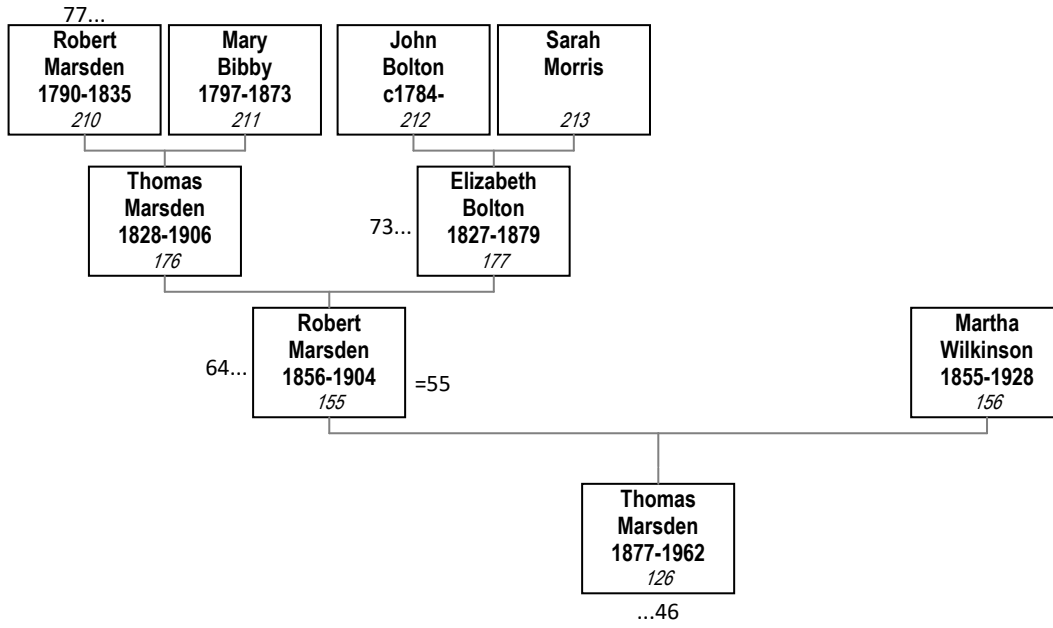

**55. Robert Marsden**

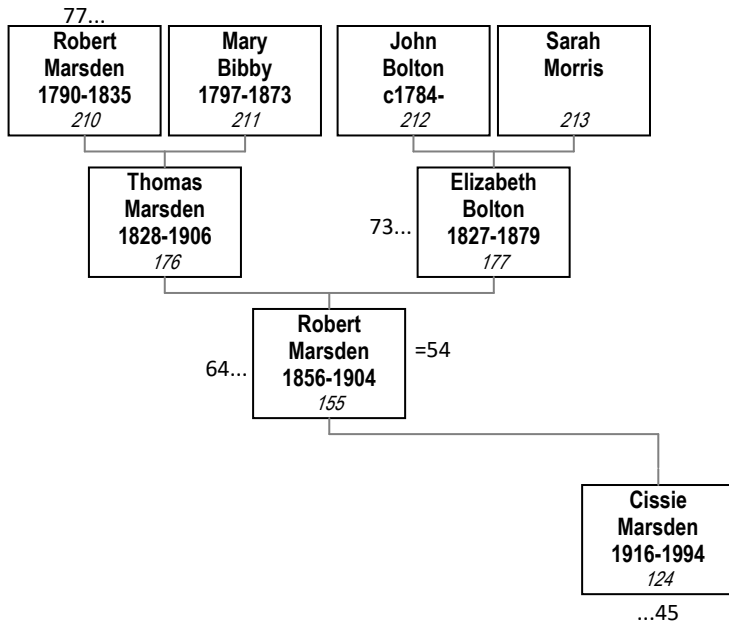

**56. Richard (Dick) Marsden and Amy Ann Woodward**

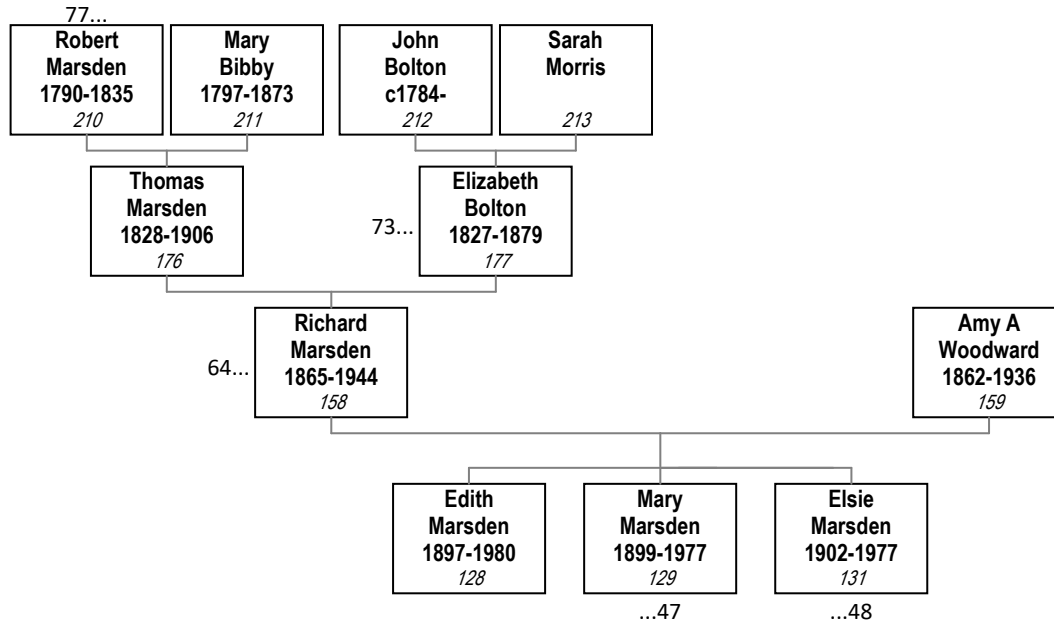

**57. William Jameson and Elizabeth Arrowsmith**

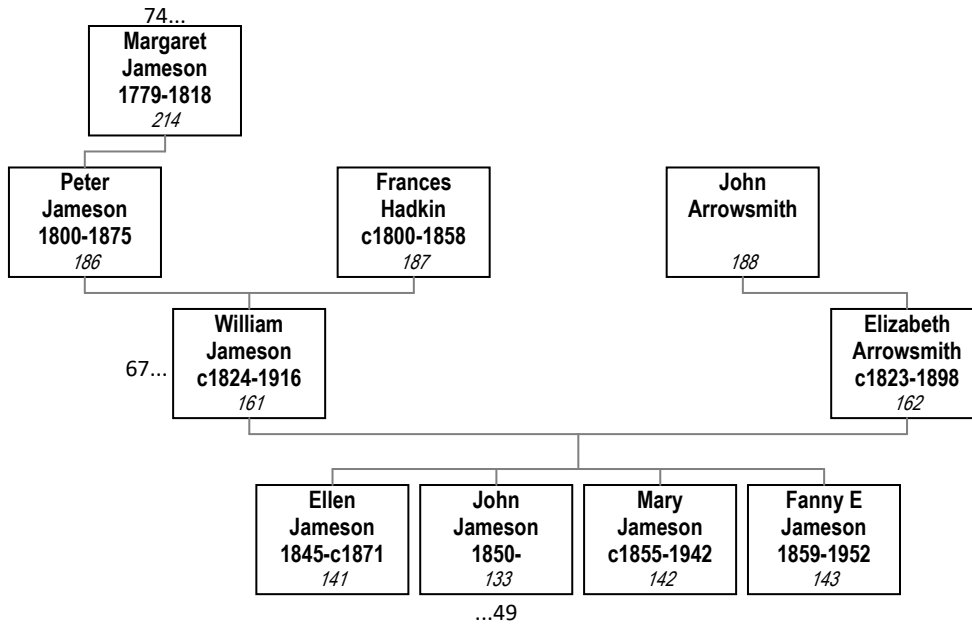

**58. Edward Corris and Jane Harrison**

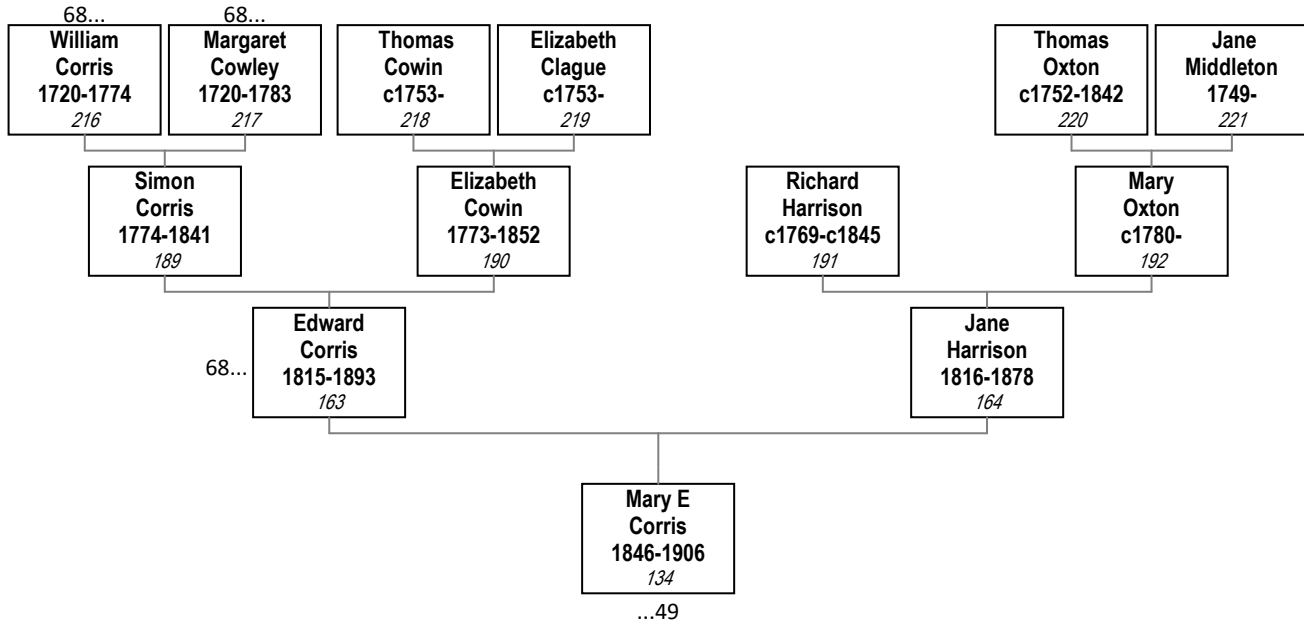

**59. William Templeman and Ann Allen**

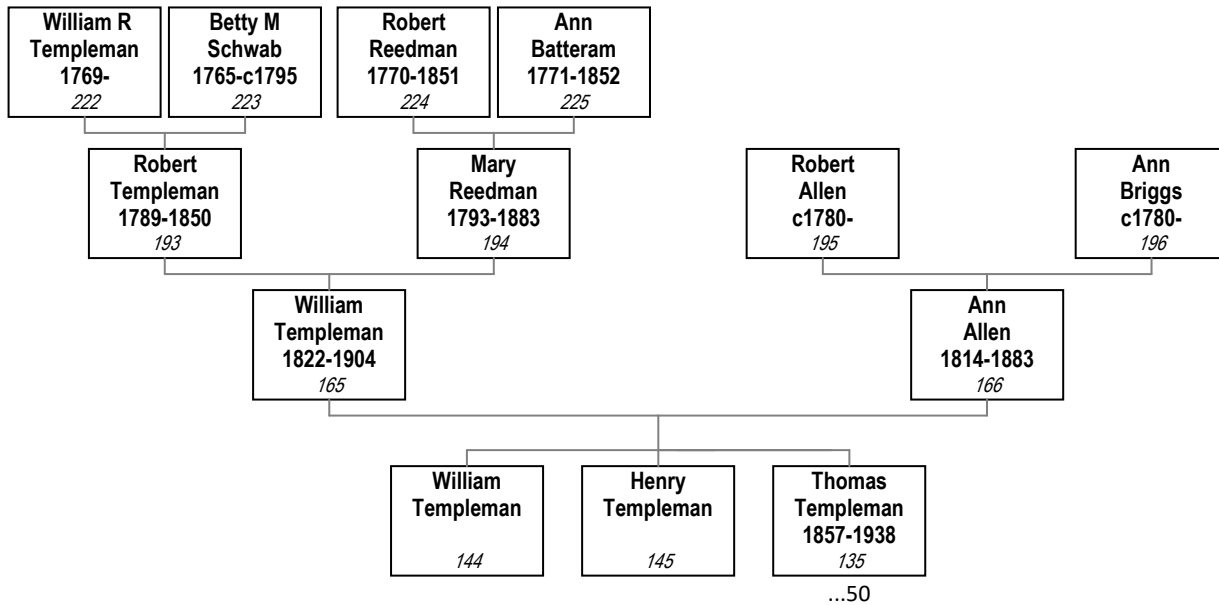

**60. Amos Cobb and Jane Stimson**

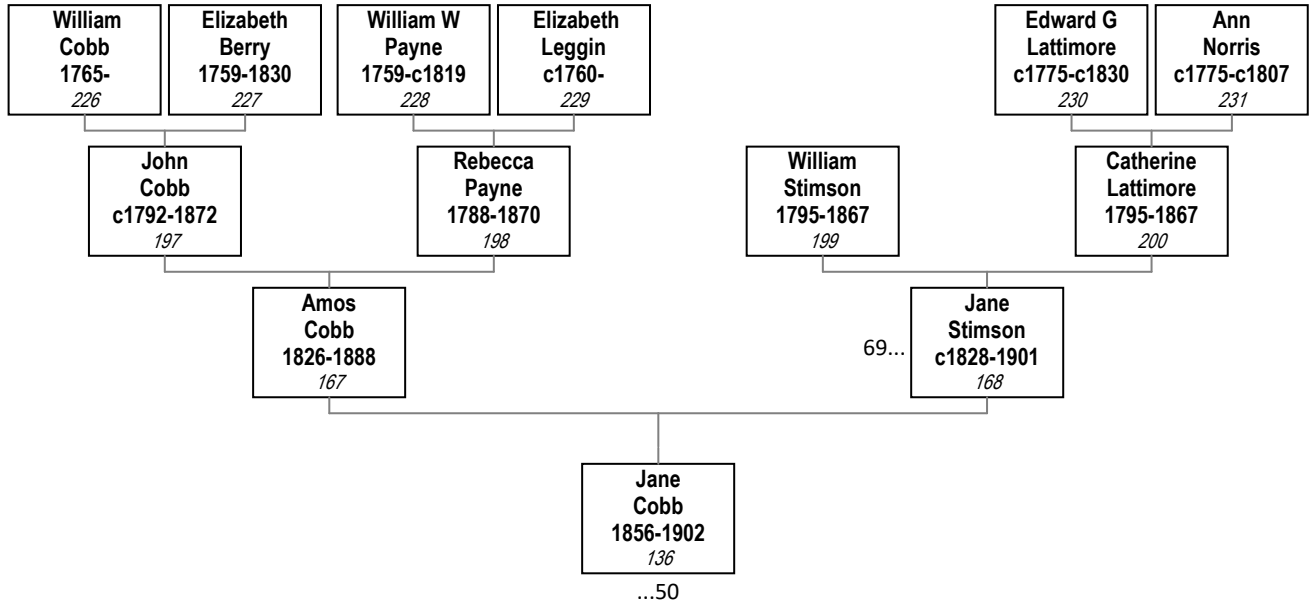

**61. Edward Roocroft and Mary Batty**

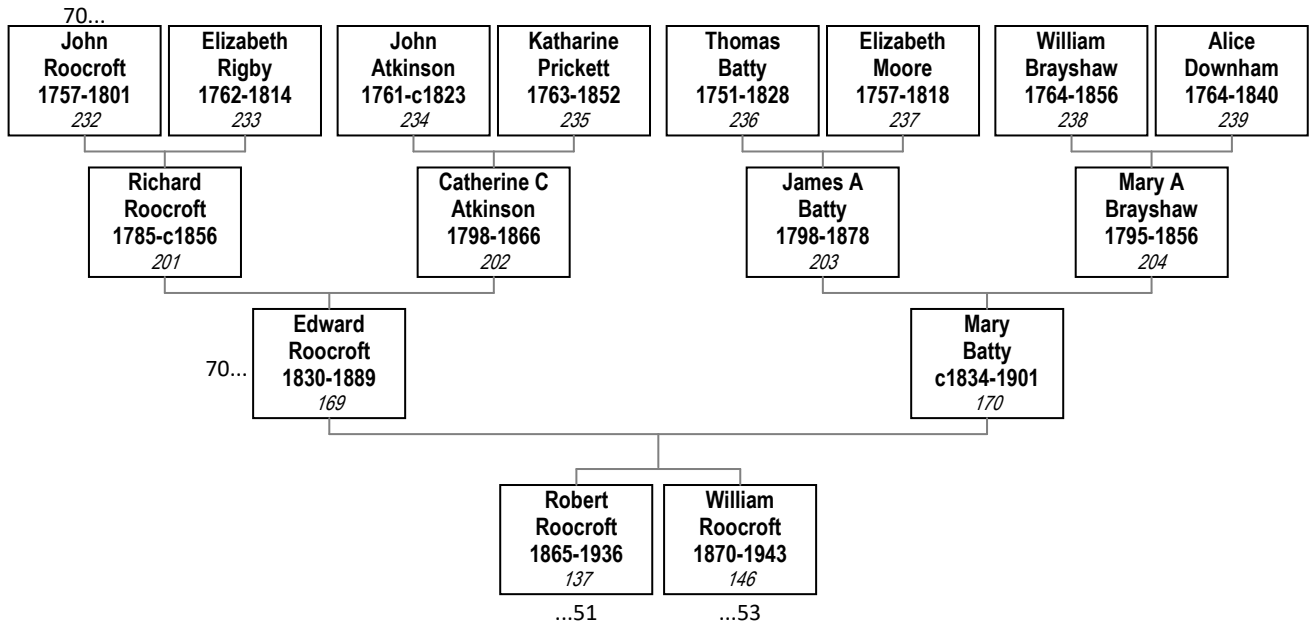

**62. James Atkinson and Jane Hodson**

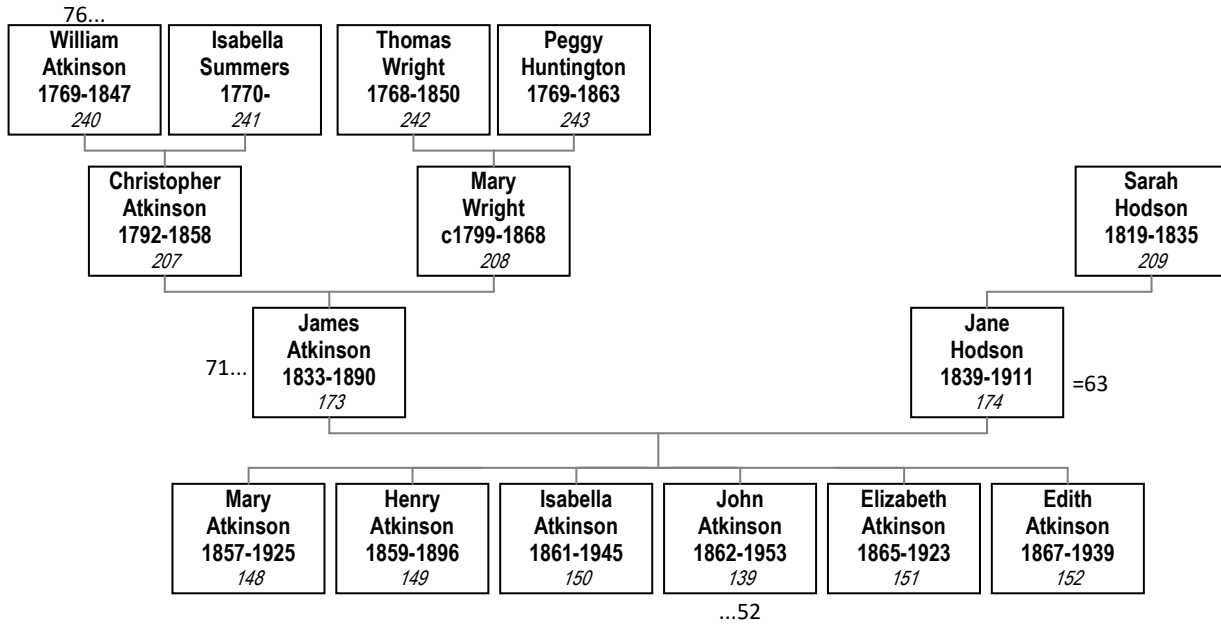

**63. Matthew Lofthouse and Jane Hodson**

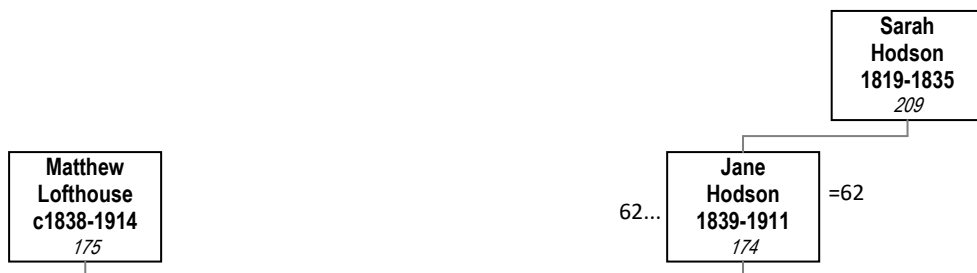

**64. Thomas Marsden and Elizabeth (Betty) Bolton**

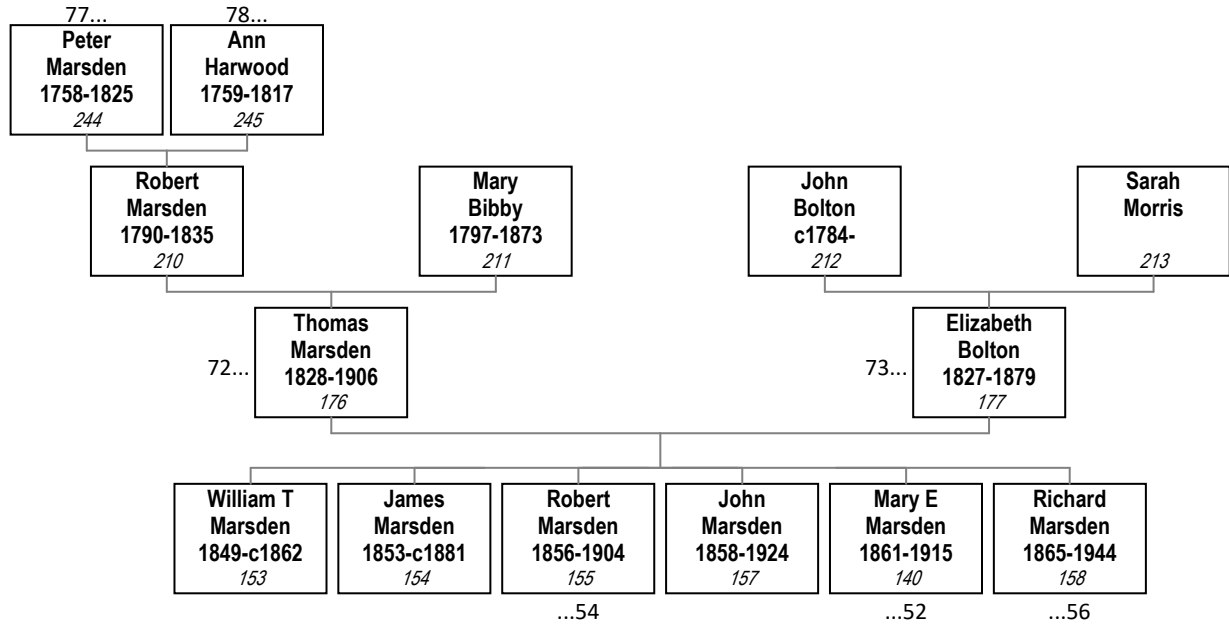

**65. Mr. Peasgood and Ann Stimson**

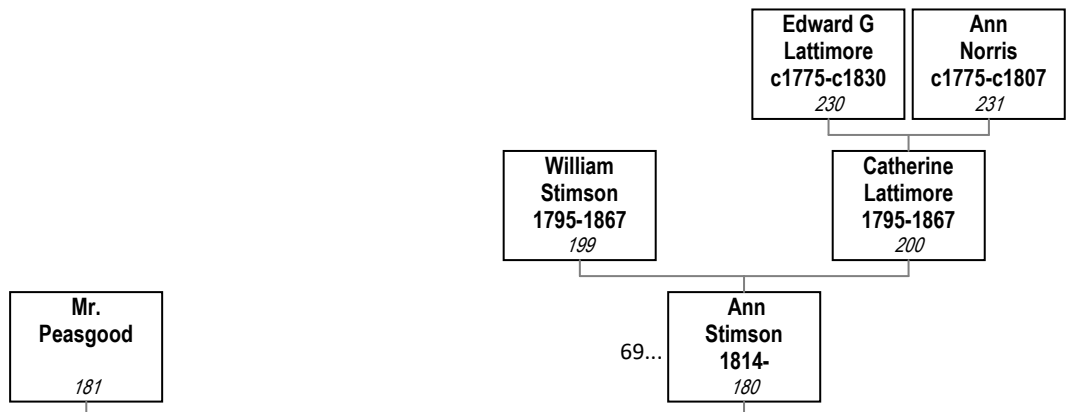

**66. John Stimson and Sarah Posnette**

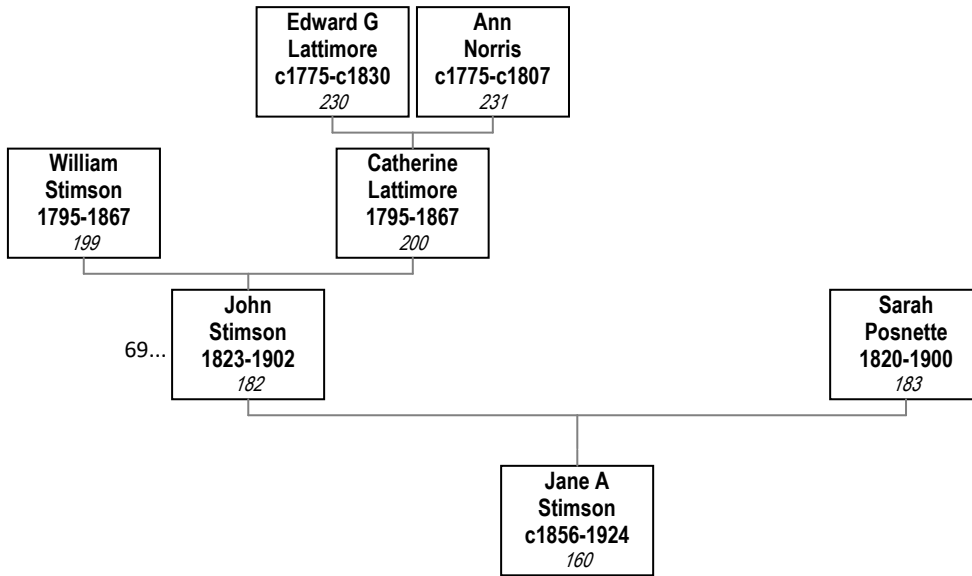

**67. Peter Jameson and Frances (Fanny) Hadkin**

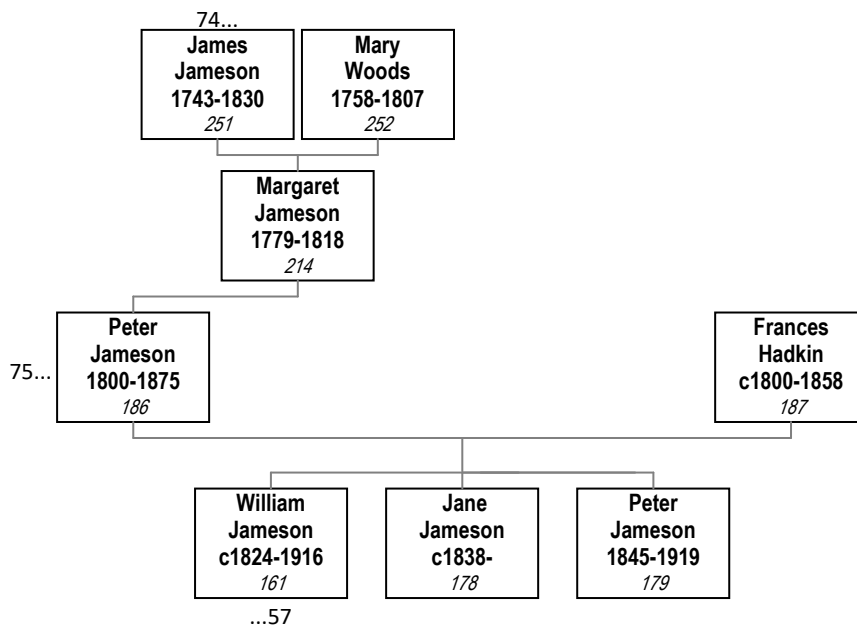

**68. Simon Corris and Elizabeth Cowin**

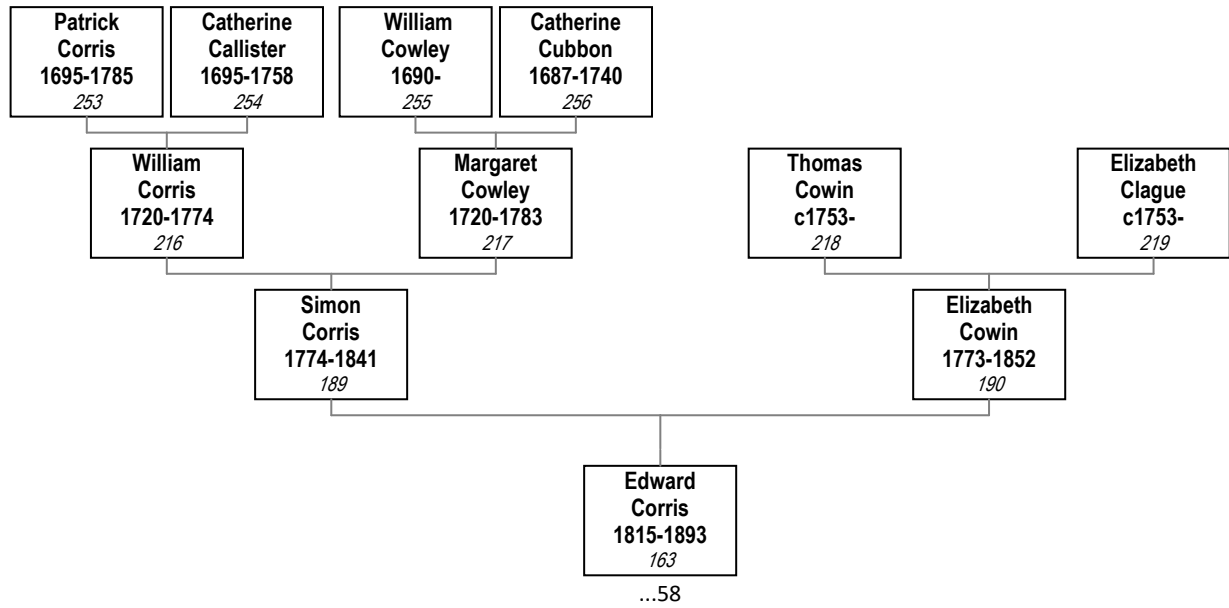

**69. William Stimson and Catherine Lattimore**

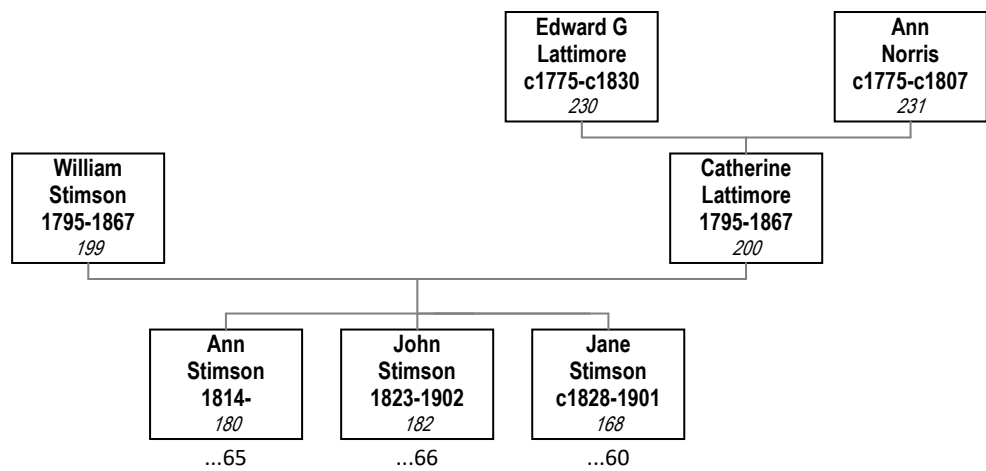

**70. Richard Roocroft and Catherine Charlotte Atkinson**

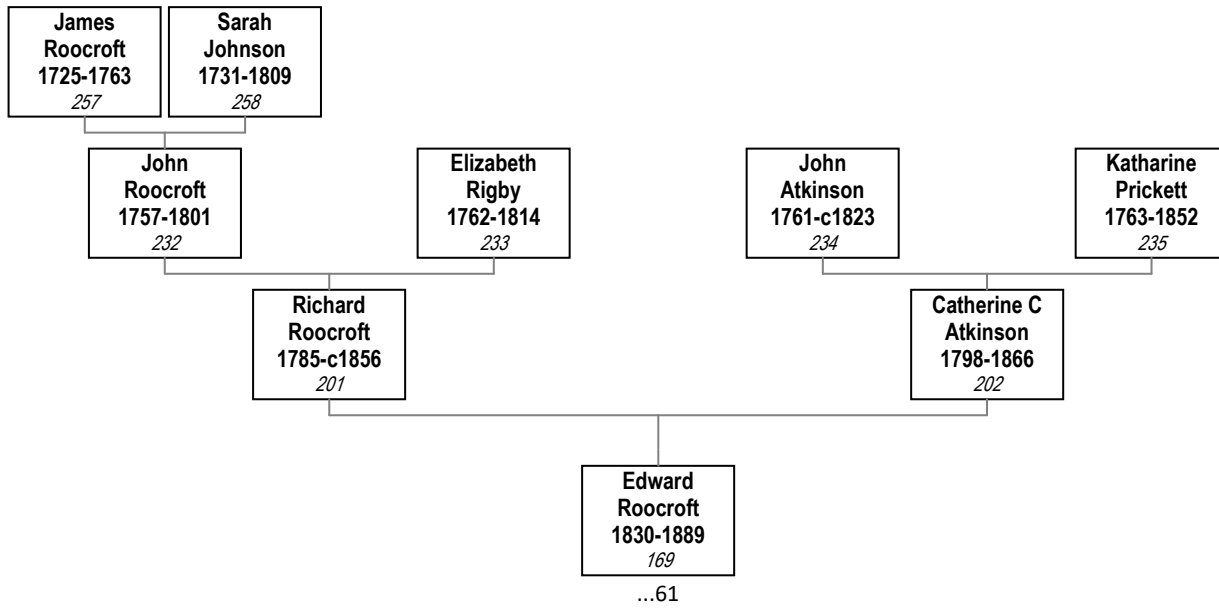

**71. Christopher Atkinson and Mary Wright**

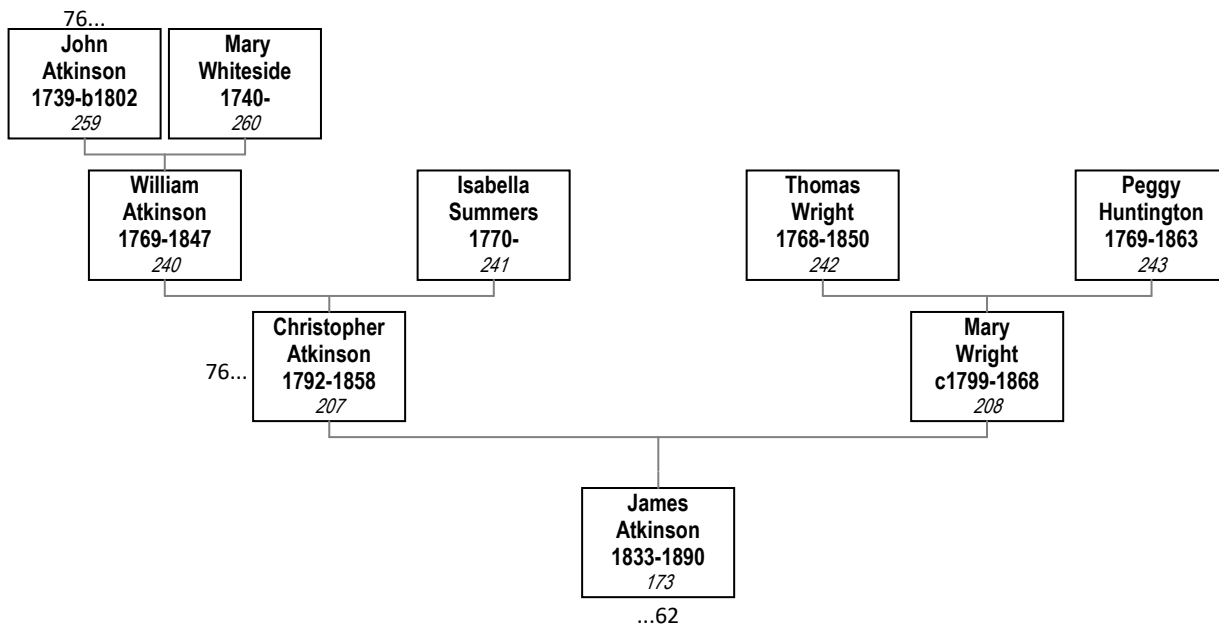

**72. Robert Marsden and Mary Bibby**

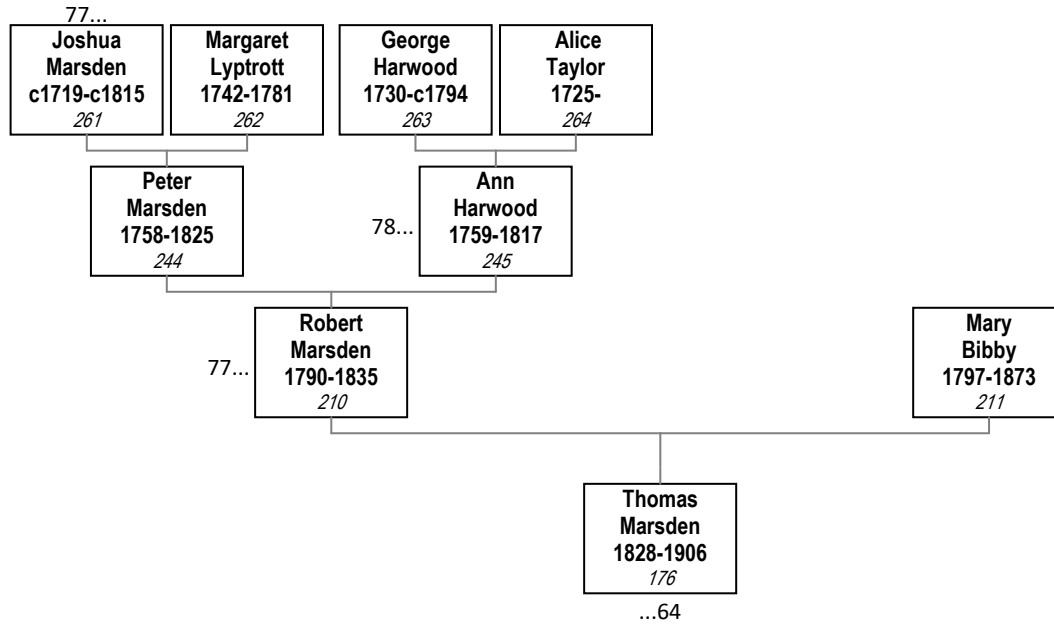

**73. John Bolton and Sarah Morris**

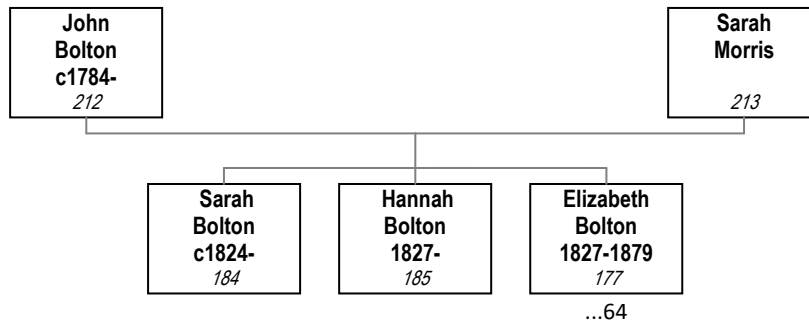

**74. William Gaskell and Margaret Jameson**

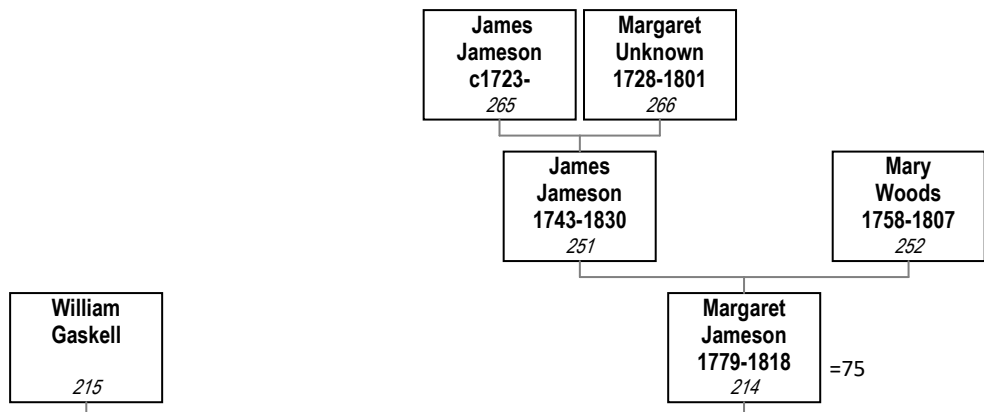

**75. Margaret Jameson**

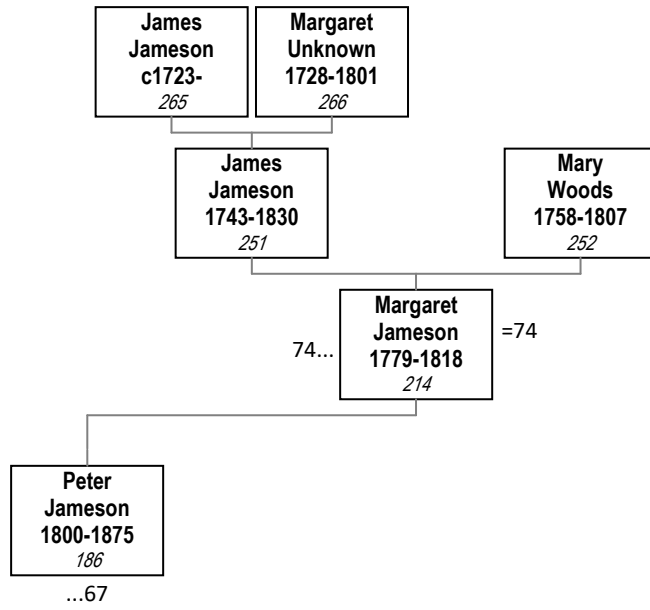

**76. William Atkinson and Isabella Summers**

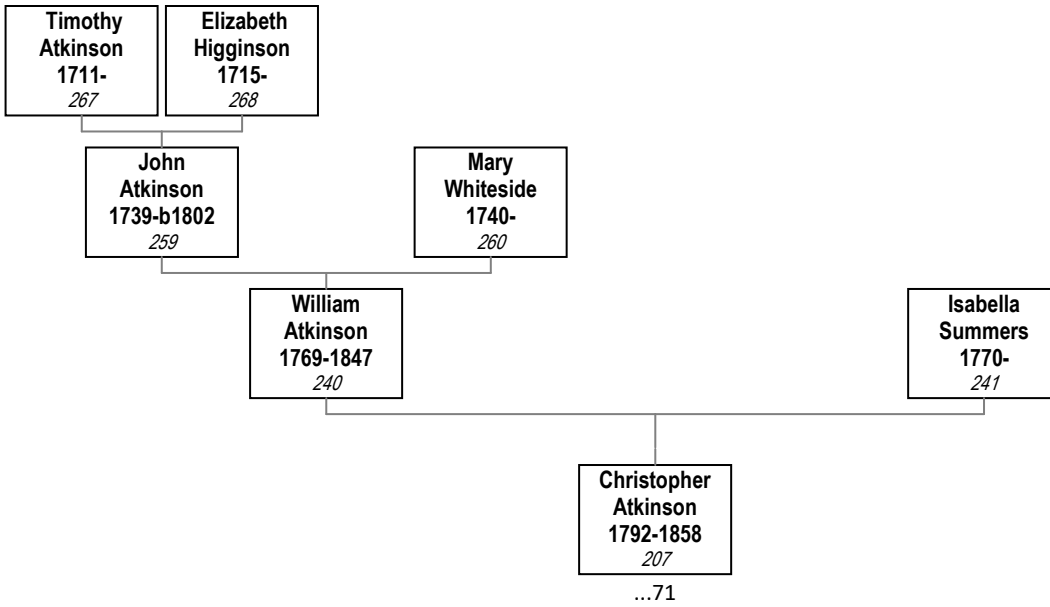

**77. Peter Marsden and Ann (Nancy) Harwood**

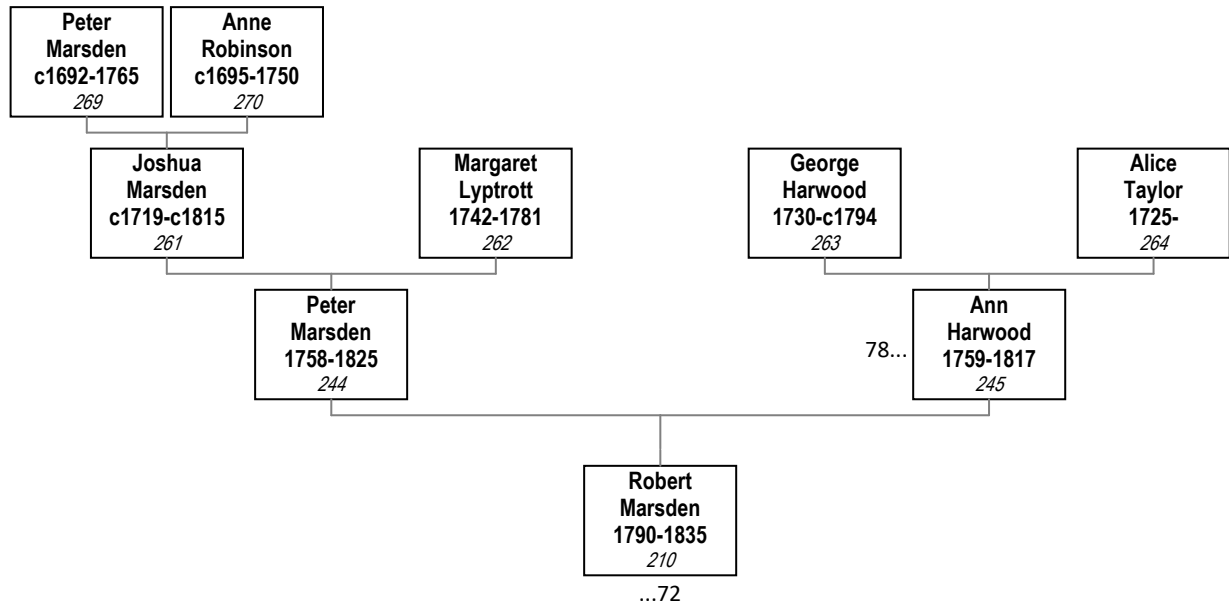

**78. George Harwood and Alice Taylor**

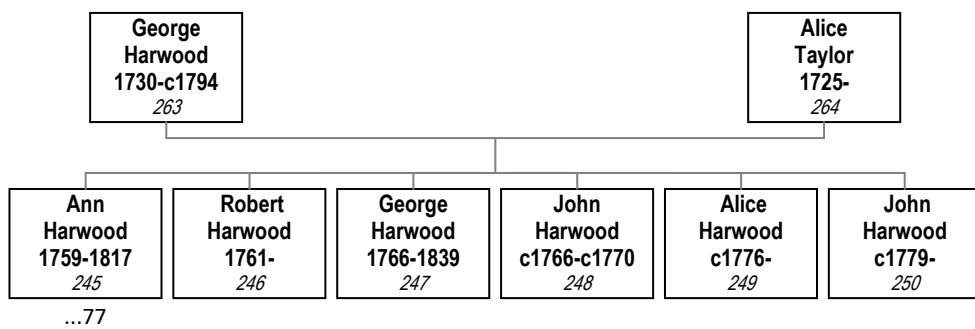

**7. INDEX OF PLACES**

**21 ASTBURY AVENUE AUDENSHAW LANCASHIRE**

Death of William Corris Jameson<sup>103</sup> on 4 January 1939.

**BERKSHIRE, HAMPSHIRE, ISLE OF WIGHT, OXFORDSHIRE, N E HANTS**

Birth of James Richard Somersall<sup>26</sup> in July 1978.

**BLACKBURN**

Residence of James Marsden<sup>154</sup>.

**BOLTON**

Death of Isabella Atkinson<sup>150</sup> in 1945.

**BOLTON LANCASHIRE 21 / 122**

Death of George Harwood<sup>247</sup> in December 1839.

**BOLTON LANCASHIRE**

Marriage of Robert Marsden<sup>155</sup> and Martha Wilkinson<sup>156</sup> in October 1876.

**BOLTON LANCASHIRE 8C / 352**

Death of Martha Wilkinson<sup>156</sup> in April 1928.

**BOLTON, 139 MERE HALL ST**

Residence of James Roocroft<sup>101</sup> in 1915.

**BOLTON, DEANE, HEATON**

Birth of Robert Harwood<sup>246</sup> in 1761.

Birth of George Harwood<sup>247</sup> in 1766.

Birth of John Harwood<sup>248</sup> about 1766.

**CANADA, BRITISH COLUMBIA, VANCOUVER**

Death of Thomas Harold Roocroft<sup>118</sup> on 13 August 1955.

**CHERRY HINTON**

Death of Elizabeth Moore<sup>237</sup> in January 1818.

**CHINA, YUNNAN, KUENMING SHIQU, KUNMING**

Birth of Ximeng Lucy Fan<sup>37</sup>.

**CO.DURHAM, CRAGHEAD**

Birth of Sarah Gardiner<sup>82</sup> on 14 September 1914.

**CO.DURHAM, DURHAM**

Death of Sarah Gardiner<sup>82</sup> on 26 April 1996.

**DEANE, HALLIWELL**

Birth of Alice Harwood<sup>249</sup> about 1776.

**DERBYSHIRE, DERBY**

Birth of Pauline Anne Jablonski<sup>32</sup> in July 1978.

Birth of Simon Andrew Jablonski<sup>33</sup> in October 1979.

Birth of Timothy John Jablonski<sup>34</sup> in January 1982.

Birth of Robert Anthony Jablonski<sup>35</sup> in June 1985.

**DURHAM, DURHAM CENTRAL**

Birth of Tristan Thomas Somersall<sup>5</sup> in August 2003.

**DURHAM, DURHAM NORTHERN**

Birth of Paula Elizabeth Anderson<sup>27</sup> in April 1976.

Birth of Nathan James Somersall<sup>4</sup> in June 1997.

**EDINBURGH, DEAN VILLAGE**

Residence of Andrew John Jameson<sup>40</sup> in January 1991.

**ENGLAND**

Death of Elizabeth Leggin<sup>229</sup>.

**ENGLAND, CAMBRIDGESHIRE, LINTON**

Birth of Elizabeth Moore<sup>237</sup> on 12 June 1757.

**ENGLAND, CHESHIRE**

Death of Jane Middleton<sup>221</sup>.

**ENGLAND, CHESHIRE, BIRKENHEAD**

Death of Edward Corris<sup>163</sup> in December 1893.

**ENGLAND, CHESHIRE, GREASBY**

Birth of Mary Oxton<sup>192</sup> about 1780.

**ENGLAND, CHESHIRE, LOWER TRANMERE**

Death of Richard Harrison<sup>191</sup> about 1845.

**ENGLAND, CHESHIRE, PRESTBURY**

Marriage of Peter Marsden<sup>244</sup> and Ann (Nancy) Harwood<sup>245</sup> on 12 August 1769.

**ENGLAND, CHESHIRE, ROCK FERRY**

Birth of William Corris Jameson<sup>103</sup> in December 1878.

**ENGLAND, CHESHIRE, STORETON**

Death of Thomas Oxton<sup>220</sup> in June 1842.

**ENGLAND, CHESHIRE, THURSTATON**

Birth of Richard Harrison<sup>191</sup> about 1769.

**ENGLAND, CHESHIRE, TRANMERE**

Birth of Jane Harrison<sup>164</sup> on 20 December 1816.

Birth of Mary Elizabeth Corris<sup>134</sup> in September 1846.

**ENGLAND, CHESHIRE, TRANMERE, ST PAULS**

Marriage of John Jameson<sup>133</sup> and Mary Elizabeth Corris<sup>134</sup> on 31 July 1878.

**ENGLAND, CHESHIRE, UPTON BY BIRKENHEAD**

Birth of Jane Middleton<sup>221</sup> on 5 September 1749.

**ENGLAND, CHESHIRE, WARRINGTON**

Death of Leslie James Harwood<sup>94</sup> in 2006.

**ENGLAND, CHESHIRE, WEST KIRBY**

Birth of Thomas Oxton<sup>220</sup> about 1752.

**ENGLAND, COUNTY DURHAM, DURHAM**

Residence of Paula Elizabeth Anderson<sup>27</sup> '2011–2018'.

**ENGLAND, DERBYSHIRE, GLOSSOP**

Death of William Rookcroft<sup>113</sup> on 25 April 1936.

**ENGLAND, DURHAM, CRAGHEAD**

Marriage of John Corris Jameson<sup>81</sup> and Sarah Gardiner<sup>82</sup> on 31 December 1939.

**ENGLAND, GREATER MANCHESTER, METROPOLITAN BOROUGH OF WIGAN, WIGAN**

Burial of Margaret Jameson<sup>214</sup>.

**ENGLAND, GREATER MANCHESTER, STOCKPORT**

Death of Cissie Marsden<sup>124</sup> on 25 April 1994.

**ENGLAND, HAMPSHIRE, ANDOVER**

Residence of Judith Anne Whitehurst<sup>41</sup> in 1985.

Residence of John Ross Jameson<sup>6</sup> in 2013.

**ENGLAND, HAMPSHIRE, APPLESRAW**

Residence of Andrew John Jameson<sup>40</sup> in September 1985.

**ENGLAND, HUNTINGDONSHIRE, STIBBINGTON**

Birth of William Stimson<sup>199</sup> in 1795.

**ENGLAND, ISLE OF MAN, KIRK GERMAN**

Birth of William Corris<sup>216</sup> in 1720.

Marriage of Simon Corris<sup>189</sup> and Elizabeth Cowin<sup>190</sup> on 16 November 1794.

**ENGLAND, ISLE OF MAN, PATRICK**

Marriage of William Corris<sup>216</sup> and Margaret Cowley<sup>217</sup> on 14 August 1744.

**ENGLAND, KENT, CANTERBURY**

Death of Brenda Jameson<sup>84</sup> on 21 March 2014.

**ENGLAND, KENT, CHATHAM**

Death of Janik Jablonski<sup>85</sup> on 19 April 1985.

**ENGLAND, LANCASHIRE**

Birth of Thomas Wright<sup>242</sup> in 1768.

Death of Thomas Walsh Best<sup>171</sup> on 23 January 1907.

Residence of John Corris Jameson<sup>81</sup> in 1939.

Residence of Donald Templeman Jameson<sup>87</sup> in 1939.

Residence of Kathleen Nina Jameson<sup>86</sup> in 1939.

Residence of Amelia Ann Jameson<sup>105</sup> in 1939.

Residence of George O A Sellen<sup>106</sup> in 1939.

Residence of Edward Dennis Jameson<sup>83</sup> in 1939.

Burial of Amelia Ann Jameson<sup>105</sup> on 17 July 1953.

Burial of John Corris Jameson<sup>81</sup> on 10 November 1976.

Burial of Dora Marsden Atkinson<sup>102</sup> on 31 December 1981.

Burial of James Roocroft<sup>101</sup> on 28 February 1984.

Death of Aileen Mary King<sup>123</sup> on 7 February 1989.

**ENGLAND, LANCASHIRE, ALL SAINTS, WIGAN**

Marriage of Peter Marsden<sup>269</sup> and Anne Robinson<sup>270</sup> on 23 April 1717.

Baptism of James Jameson<sup>251</sup> on 25 March 1743.

Marriage of William Gaskell<sup>215</sup> and Margaret Jameson<sup>214</sup> on 1 April 1799.

Baptism of Peter Jameson<sup>186</sup> on 13 October 1800.

Burial of James Jameson<sup>251</sup> on 6 January 1830.

**ENGLAND, LANCASHIRE, BLACKBURN**

Birth of Martha Wilkinson<sup>156</sup> in 1855.

**ENGLAND, LANCASHIRE, BLACKPOOL**

Death of Matthew Lofthouse<sup>175</sup> on 19 June 1914.

Death of Edith Atkinson<sup>152</sup> in 1939.

**ENGLAND, LANCASHIRE, BOLTON**

Birth of Sarah Morris<sup>213</sup>.

Birth of George Harwood<sup>263</sup> in 1730.

Birth of Sarah Hodson<sup>209</sup> in 1819.

Birth of Sarah Bolton<sup>184</sup> about 1824.

Birth of Elizabeth (Betty) Bolton<sup>177</sup> in 1827.

Death of Sarah Hodson<sup>209</sup> on 21 October 1835.

Birth of Thomas Walsh Best<sup>171</sup> in 1837.

Birth of Mary Ann Ashburn<sup>172</sup> in 1839.

Birth of Jane Hodson<sup>174</sup> on 15 July 1839.

Birth of Mary Atkinson<sup>148</sup> in 1857.

Death of Christopher Atkinson<sup>207</sup> in 1858.

Birth of Henry Atkinson<sup>149</sup> in 1859.

Birth of Isabella Atkinson<sup>150</sup> in 1861.

Birth of John Atkinson<sup>139</sup> on 8 June 1862.

Birth of Robert Roocroft<sup>137</sup> on 1 January 1865.

Birth of Richard (Dick) Marsden<sup>158</sup> in 1865.

Birth of Elizabeth Atkinson<sup>151</sup> in 1865.

**ENGLAND, LANCASHIRE, BOLTON (Continued)**

- Birth of Edith Atkinson<sup>152</sup> in 1867.  
 Death of Mary Wright<sup>208</sup> in 1868.  
 Birth of Elizabeth Evelyne Best<sup>138</sup> in July 1869.  
 Birth of William Roocroft<sup>146</sup> on 11 April 1870.  
 Birth of Clara Talbot<sup>147</sup> on 18 February 1873.  
 Marriage of John Atkinson<sup>139</sup> and Mary Ellen Marsden<sup>140</sup> in October 1885.  
 Death of Edward Roocroft<sup>169</sup> on 23 January 1889.  
 Death of James Atkinson<sup>173</sup> in April 1890.  
 Marriage of Matthew Lofthouse<sup>175</sup> and Jane Hodson<sup>174</sup> on 27 June 1891.  
 Marriage of Robert Roocroft<sup>137</sup> and Elizabeth Evelyne Best<sup>138</sup> in April 1893.  
 Birth of William Roocroft<sup>113</sup> in April 1893.  
 Birth of Alice Roocroft<sup>114</sup> on 21 January 1894.  
 Birth of Ethel Roocroft<sup>116</sup> on 17 April 1895.  
 Death of Henry Atkinson<sup>149</sup> on 31 December 1896.  
 Marriage of William Roocroft<sup>146</sup> in April 1897.  
 Birth of Ernest Croft Wood<sup>121</sup> on 23 August 1897.  
 Birth of James Roocroft<sup>101</sup> on 8 October 1897.  
 Birth of Linda Marsden Atkinson<sup>120</sup> in January 1898.  
 Birth of Thomas Harold Roocroft<sup>118</sup> on 24 June 1898.  
 Birth of Mary (Polly) Elizabeth Marsden<sup>129</sup> in 1899.  
 Birth of Dora Marsden Atkinson<sup>102</sup> on 16 December 1899.  
 Birth of Edward Walsh Roocroft<sup>119</sup> on 5 September 1901.  
 Death of Mary Batty<sup>170</sup> on 7 September 1901.  
 Death of Mary Elizabeth Corris<sup>134</sup> in September 1906.  
 Birth of Eric Talbot Roocroft<sup>122</sup> on 18 August 1908.  
 Residence of Amy Ann Woodward<sup>159</sup> in 1911.  
 Residence of Lucy Pendlebury<sup>127</sup> in 1911.  
 Residence of William Roocroft<sup>146</sup> in 1911.  
 Marriage of Edward Corris Jameson<sup>99</sup> in April 1913.  
 Marriage of Edward Corris Jameson<sup>99</sup> and Emma Templeman<sup>100</sup> on 25 June 1913.  
 Marriage of Charles Watkin Jones<sup>115</sup> in October 1913.  
 Birth of John Corris Jameson<sup>81</sup> on 19 March 1914.  
 Residence of Robert Roocroft<sup>137</sup> in 1915.  
 Death of Mary Ellen Marsden<sup>140</sup> on 3 November 1915.  
 Birth of Muriel Irene Jones<sup>92</sup> on 5 September 1917.  
 Baptism of Muriel Irene Jones<sup>92</sup> on 9 December 1917.  
 Birth of Edward Dennis Jameson<sup>83</sup> on 1 March 1920.  
 Residence of Edward Dennis Jameson<sup>83</sup> in 1921.  
 Residence of John Corris Jameson<sup>81</sup> in 1921.  
 Residence of Emma Templeman<sup>100</sup> in 1921.  
 Residence of Edward Corris Jameson<sup>99</sup> in 1921.  
 Residence of Charles Watkin Jones<sup>115</sup> in 1921.  
 Residence of Alice Roocroft<sup>114</sup> in 1921.  
 Residence of Muriel Irene Jones<sup>92</sup> in 1921.  
 Birth of Brenda Jameson<sup>84</sup> on 8 October 1921.  
 Marriage of Herbert Campbell<sup>117</sup> and Ethel Roocroft<sup>116</sup> in April 1923.  
 Death of Elizabeth Atkinson<sup>151</sup> in 1923.  
 Birth of Kathleen Nina Jameson<sup>86</sup> on 14 July 1923.  
 Marriage of Ernest Croft Wood<sup>121</sup> and Linda Marsden Atkinson<sup>120</sup> in July 1923.  
 Death of Lucy Pendlebury<sup>127</sup> in October 1923.  
 Birth of Margaret Linda Wood<sup>93</sup> on 13 June 1924.  
 Birth of Donald Templeman Jameson<sup>87</sup> on 29 December 1924.  
 Birth of John Derek Wood<sup>95</sup> on 13 July 1926.  
 Birth of Robert Bryan Jameson<sup>79</sup> in December 1926.  
 Marriage of James Roocroft<sup>101</sup> and Dora Marsden Atkinson<sup>102</sup> on 5 October 1927.  
 Marriage of John Thomas Lomax<sup>130</sup> and Mary (Polly) Elizabeth Marsden<sup>129</sup> on 4 March 1930.  
 Birth of John Marsden Roocroft<sup>89</sup> in July 1931.  
 Marriage of Eric Talbot Roocroft<sup>122</sup> and Aileen Mary King<sup>123</sup> in April 1935.  
 Death of Robert Roocroft<sup>137</sup> in April 1936.  
 Death of Amy Ann Woodward<sup>159</sup> in July 1936.  
 Birth of David Ewart Roocroft<sup>97</sup> on 19 July 1936.  
 Birth of Irene Elizabeth McDonald Brock<sup>98</sup> in 1937.  
 Birth of Joan Haddock<sup>90</sup> in July 1937.  
 Birth of Roy Wardle<sup>49</sup> on 11 February 1941.  
 Death of William Roocroft<sup>146</sup> on 5 July 1943.

**ENGLAND, LANCASHIRE, BOLTON (Continued)**

Death of Edward Dennis Jameson<sup>83</sup> on 27 July 1944.  
 Birth of Edwina M Jablonski<sup>54</sup> in July 1948.  
 Marriage of Albert Lord<sup>132</sup> and Elsie Marsden<sup>131</sup> in October 1948.  
 Marriage of Robert Bryan Jameson<sup>79</sup> and Mary Atkinson Roorcroft<sup>80</sup> in January 1951.  
 Death of Edward Corris Jameson<sup>99</sup> on 13 April 1951.  
 Marriage of John Derek Wood<sup>95</sup> and Barbara E Bibby<sup>96</sup> in January 1953.  
 Residence of Kathleen Nina Jameson<sup>86</sup>.  
 Marriage of Donald Templeman Jameson<sup>87</sup> and Sheila Sanderson<sup>88</sup> on 12 August 1953.  
 Birth of Linda Jane Jameson<sup>44</sup> on 20 September 1954.  
 Birth of Richard D Jameson<sup>64</sup> in January 1956.  
 Marriage of Leslie James Harwood<sup>94</sup> and Margaret Linda Wood<sup>93</sup> in July 1956.  
 Residence of Robert Bryan Jameson<sup>79</sup> '2003–2004'.  
 Residence of Robert Bryan Jameson<sup>79</sup>.  
 Birth of Peter M Jameson<sup>65</sup> in April 1957.  
 Birth of Kathryn Mary Jameson<sup>46</sup> on 8 August 1957.  
 Death of Clara Talbot<sup>147</sup> on 13 November 1957.  
 Birth of Beverley J Thornley<sup>78</sup> in April 1958.  
 Marriage of John Marsden Roorcroft<sup>89</sup> and Joan Haddock<sup>90</sup> in July 1958.  
 Death of Alice Roorcroft<sup>114</sup> on 12 January 1959.  
 Birth of Jean S Jameson<sup>66</sup> in October 1959.  
 Marriage of David Ewart Roorcroft<sup>97</sup> and Irene Elizabeth McDonald Brock<sup>98</sup> on 8 June 1960.  
 Birth of Simon A Roorcroft<sup>77</sup> in October 1961.  
 Marriage of Roy Wardle<sup>49</sup> and Margaret Jameson<sup>48</sup> on 20 July 1966.  
 Death of Emma Templeman<sup>100</sup> on 25 December 1966.  
 Birth of Robin Marcus Wardle<sup>21</sup> in January 1969.  
 Birth of Edward Jonathan Wardle<sup>23</sup> in January 1971.  
 Birth of Timothy James Wardle<sup>24</sup> in April 1973.  
 Marriage of Andrew John Jameson<sup>40</sup> and Judith Anne Whitehurst<sup>41</sup> in December 1977.  
 Death of Ethel Roorcroft<sup>116</sup> on 2 July 1978.  
 Death of Dora Marsden Atkinson<sup>102</sup> on 24 December 1981.  
 Death of James Roorcroft<sup>101</sup> on 22 February 1984.  
 Residence of David Ewart Roorcroft<sup>97</sup> in 1984.  
 Birth of Linda Charlotte Vickers<sup>17</sup> on 20 November 1985.  
 Birth of Thomas William Vickers<sup>19</sup> on 15 May 1987.  
 Death of Eric Talbot Roorcroft<sup>122</sup> on 28 May 1987.  
 Marriage of Simon A Roorcroft<sup>77</sup> and Beverley J Thornley<sup>78</sup> in 1987.  
 Residence of David J Roorcroft<sup>71</sup>.  
 Birth of Benjamin James Vickers<sup>20</sup> on 7 April 1989.  
 Residence of Simon A Roorcroft<sup>77</sup> '2003–2004'.  
 Death of Kathleen Nina Jameson<sup>86</sup> on 10 January 2001.  
 Death of Robert Bryan Jameson<sup>79</sup> on 16 April 2012.  
 Death of Roy Wardle<sup>49</sup> on 8 December 2012.  
 Death of Margaret Jameson<sup>48</sup> on 11 April 2019.

**ENGLAND, LANCASHIRE, BOLTON-LE-MOORS**

Marriage of James Atkinson<sup>173</sup> and Jane Hodson<sup>174</sup> on 19 November 1856.  
 Baptism of Richard (Dick) Marsden<sup>158</sup> on 12 February 1865.

**ENGLAND, LANCASHIRE, BOLTON-LE-MOORS, ST PETER**

Marriage(?) of Peter Marsden<sup>244</sup> and Ann (Nancy) Harwood<sup>245</sup> on 13 September 1780.

**ENGLAND, LANCASHIRE, BOLTON LE MOORS, SAINT PETER**

Marriage of Peter Jameson<sup>186</sup> and Frances (Fanny) Hadkin<sup>187</sup> on 4 June 1820.

**ENGLAND, LANCASHIRE, BOLTON, AND RUMWORTH, DAUBHILL, BOLTON**

Residence of Robert Marsden<sup>155</sup> in 1901.  
 Residence of Thomas Marsden<sup>126</sup> in 1901.  
 Residence of Martha Wilkinson<sup>156</sup> in 1901.

**ENGLAND, LANCASHIRE, BOLTON, DAUBHILL**

Birth of Edith Marsden<sup>128</sup> in 1897.

**ENGLAND, LANCASHIRE, BOLTON, HALLIWELL**

Birth of Mary Ellen Marsden<sup>140</sup> in April 1861.

**ENGLAND, LANCASHIRE, BOLTON, HAVERCROFT**

Birth of Andrew John Jameson<sup>40</sup> on 5 April 1952.

**ENGLAND, LANCASHIRE, BOLTON, LITTLE HULTON**

Birth of Thomas Marsden<sup>126</sup> on 18 September 1877.

**ENGLAND, LANCASHIRE, CABUS**

Birth of Mary Wright<sup>208</sup> about August 1799.

**ENGLAND, LANCASHIRE, CARTMEL**

Birth of Edward Roocroft<sup>169</sup> in 1830.

**ENGLAND, LANCASHIRE, CHORLEY**

Birth of Thomas Marsden<sup>176</sup> in 1828.

**ENGLAND, LANCASHIRE, CHORLEY, ASTLEY VILLAGE**

Residence of Andrew John Jameson<sup>40</sup> in August 2003.

**ENGLAND, LANCASHIRE, CHORLEY, CROSTON**

Death of Elizabeth Rigby<sup>233</sup> in 1814.

**ENGLAND, LANCASHIRE, CHORLTON CUM HARDY**

Residence of Andrew John Jameson<sup>40</sup> in September 1999.

**ENGLAND, LANCASHIRE, DEAN**

Birth of Robert Marsden<sup>210</sup> on 3 September 1790.

**ENGLAND, LANCASHIRE, FYLDE**

Death of Mary Atkinson<sup>148</sup> in 1925.

Death of John Jameson<sup>107</sup> in July 1958.

**ENGLAND, LANCASHIRE, GARSTANG**

Marriage of Christopher Atkinson<sup>207</sup> and Mary Wright<sup>208</sup> on 20 March 1820.

Birth of James Atkinson<sup>173</sup> in 1833.

Death of Thomas Wright<sup>242</sup> in May 1850.

Death of Peggy (Margaret) Huntington<sup>243</sup> in 1863.

**ENGLAND, LANCASHIRE, GREAT HARWOOD**

Birth of James Marsden<sup>154</sup> in 1853.

Birth of John Marsden<sup>157</sup> in 1858.

**ENGLAND, LANCASHIRE, GREAT HARWOOD (Continued)**

Burial of William Thomas Marsden<sup>153</sup> on 2 June 1862.

Burial of James Marsden<sup>154</sup> on 22 February 1881.

**ENGLAND, LANCASHIRE, GREAT HARWOOD, ST LAWRENCE**

Residence of Robert Marsden<sup>155</sup> in 1861.

Residence of John Marsden<sup>157</sup> in 1861.

Residence of Elizabeth (Betty) Bolton<sup>177</sup> in 1861.

Residence of William Thomas Marsden<sup>153</sup> in 1861.

Residence of James Marsden<sup>154</sup> in 1861.

**ENGLAND, LANCASHIRE, HAIGH**

Birth of Jane Jameson<sup>178</sup> about 1838.

Birth of Peter Jameson<sup>179</sup> in 1845.

Birth of John Jameson<sup>133</sup> in 1850.

Residence of Peter Jameson<sup>186</sup> in 1851.

Birth of Fanny Elizabeth Jameson<sup>143</sup> in December 1859.

Burial of Ellen Jameson<sup>141</sup> on 19 July 1871.

Burial of Peter Jameson<sup>186</sup> on 16 January 1875.

**ENGLAND, LANCASHIRE, HALLIWELL**

Birth of Robert Marsden<sup>155</sup> in 1856.

Residence of Edward Roocroft<sup>169</sup> in 1881.

**ENGLAND, LANCASHIRE, HORWICH**

Baptism of Robert Marsden<sup>210</sup> on 29 September 1790.  
 Birth of John Jameson<sup>107</sup> about 1891.  
 Birth of Charles Watkin Jones<sup>115</sup> in 1892.

**ENGLAND, LANCASHIRE, KEARSLEY**

Residence of Elsie Marsden<sup>131</sup> in 1921.  
 Residence of Richard (Dick) Marsden<sup>158</sup> in 1921.  
 Residence of Mary (Polly) Elizabeth Marsden<sup>129</sup> in 1921.  
 Residence of Amy Ann Woodward<sup>159</sup> in 1921.  
 Residence of Edith Marsden<sup>128</sup> in 1921.

**ENGLAND, LANCASHIRE, LEVENSHULME**

Birth of Mary Bibby<sup>211</sup> in 1797.

**ENGLAND, LANCASHIRE, MANCHESTER**

Birth of James Ashburn<sup>205</sup> about 1805.  
 Birth of Elizabeth McAlpine<sup>206</sup> about 1816.  
 Marriage of James Ashburn<sup>205</sup> and Elizabeth McAlpine<sup>206</sup> on 17 November 1835.  
 Probate: James Roocroft<sup>101</sup> on 30 April 1984.

**ENGLAND, LANCASHIRE, MANCHESTER, CRUMPSALL**

Residence of Robert Marsden<sup>210</sup> in 1841.

**ENGLAND, LANCASHIRE, MIDDLE HULTON, ST GEORGE THE MARTYR, EDGE FOLD**

Residence of Elizabeth (Betty) Bolton<sup>177</sup> in 1891.  
 Residence of Richard (Dick) Marsden<sup>158</sup> in 1891.

**ENGLAND, LANCASHIRE, NATEBY**

Birth of Peggy (Margaret) Huntington<sup>243</sup> in November 1769.

**ENGLAND, LANCASHIRE, NELSON**

Birth of Sheila Sanderson<sup>88</sup> on 16 July 1930.

**ENGLAND, LANCASHIRE, OSWALDTWISTLE**

Birth of William Thomas Marsden<sup>153</sup> in 1849.

**ENGLAND, LANCASHIRE, PATRICROFT**

Birth of Amelia Ann Jameson<sup>105</sup> on 24 November 1884.

**ENGLAND, LANCASHIRE, PEMBERTON, ST JOHN THE DIVINE**

Marriage of William Jameson<sup>161</sup> and Elizabeth Arrowsmith<sup>162</sup> on 19 February 1844.

**ENGLAND, LANCASHIRE, PILLING**

Birth of John Atkinson<sup>259</sup> in 1739.

**ENGLAND, LANCASHIRE, PRESCOT**

Death of Ernest Croft Wood<sup>121</sup> in December 1973.

**ENGLAND, LANCASHIRE, PRESTON**

Birth of Jane Elizabeth Woods<sup>42</sup> on 25 May 1957.  
 Birth of Rachel Jane Watts<sup>8</sup> on 24 March 1990.

**ENGLAND, LANCASHIRE, SALFORD**

Death of Mary Ann Ashburn<sup>172</sup> in December 1922.

**ENGLAND, LANCASHIRE, SHARPLES**

Residence of John Bolton<sup>212</sup> in 1851.  
 Residence of Elizabeth (Betty) Bolton<sup>177</sup> in 1851.

**ENGLAND, LANCASHIRE, ST DENYS AND ST GEORGE, ST MARY, MANCHESTER**

Marriage(?) of James Ashburn<sup>205</sup> and Elizabeth McAlpine<sup>206</sup> on 19 June 1850.

**ENGLAND, LANCASHIRE, ST HELENS**

Birth of Leslie James Harwood<sup>94</sup> on 31 August 1924.

**ENGLAND, LANCASHIRE, ST JOHN THE EVANGELIST, FARNWORTH WITH KEARSLEY**

Baptism of Lucy Pendlebury<sup>127</sup> on 22 May 1881.

**ENGLAND, LANCASHIRE, ST MICHAEL ON WYRE**

Birth of Timothy Atkinson<sup>267</sup> in 1711.

**ENGLAND, LANCASHIRE, ST PETER, BOLTON-LE-MOORS**

Baptism of Thomas Walsh Best<sup>171</sup> on 13 August 1837.

**ENGLAND, LANCASHIRE, ST PETER, LIVERPOOL**

Marriage of Edward Corris<sup>163</sup> and Jane Harrison<sup>164</sup> on 6 September 1838.

**ENGLAND, LANCASHIRE, ST THOMAS, UPHOLLAND**

Marriage of James Jameson<sup>251</sup> and Mary Woods<sup>252</sup> on 21 September 1777.

**ENGLAND, LANCASHIRE, STALMINE**

Birth of Christopher Atkinson<sup>207</sup> in 1792.

**ENGLAND, LANCASHIRE, STANDISH**

Birth of Peter Marsden<sup>269</sup> about 1692.

Birth of Anne Robinson<sup>270</sup> about 1695.

Birth of Joshua Marsden<sup>261</sup> about 1719.

Death of Anne Robinson<sup>270</sup> in May 1750.

Marriage of Joshua Marsden<sup>261</sup> and Margaret Lyptrott<sup>262</sup> on 5 March 1753.

Death of Peter Marsden<sup>269</sup> in 1765.

**ENGLAND, LANCASHIRE, THORNTON-CLEVELEYS**

Residence of Donald Templeman Jameson<sup>87</sup>.

**ENGLAND, LANCASHIRE, THORNTON CLEVELEYS**

Death of Donald Templeman Jameson<sup>87</sup> on 23 September 2005.

**ENGLAND, LANCASHIRE, TOTTINGTON LOWER END, ST ANDREW, RAMSBOTTOM**

Residence of Thomas Marsden<sup>176</sup> in 1891.

**ENGLAND, LANCASHIRE, ULNES WALTON**

Birth of Richard Roocroft<sup>201</sup> on 24 January 1785.

**ENGLAND, LANCASHIRE, UPHOLLAND**

Birth of Elizabeth Rigby<sup>233</sup> in 1762.

**ENGLAND, LANCASHIRE, WARRINGTON**

Death of Elizabeth Evelyne Best<sup>138</sup> in September 1923.

Death of Margaret Linda Wood<sup>93</sup> in 2011.

**ENGLAND, LANCASHIRE, WIGAN**

Residence of William Gaskell<sup>215</sup>.

Christening of James Jameson<sup>251</sup> on 25 March 1743.

Birth of James Jameson<sup>251</sup> in 1743.

Birth of Margaret Jameson<sup>214</sup> on 26 August 1779.

Baptism of Margaret Jameson<sup>214</sup> on 11 September 1779.

Birth of John Bolton<sup>212</sup> about 1784.

Birth of Peter Jameson<sup>186</sup> on 22 September 1800.

Birth of Frances (Fanny) Hadkin<sup>187</sup> about 1800.

Residence of Margaret Jameson<sup>214</sup>.

Birth of William Jameson<sup>161</sup> about 1824.

Birth of Ellen Jameson<sup>141</sup> in September 1845.

Birth of Mary Jameson<sup>142</sup> about 1855.

Birth of Edward Corris Jameson<sup>99</sup> on 30 April 1880.

Birth of Jane Corris Jameson<sup>104</sup> in June 1882.

Death of Peter Jameson<sup>179</sup> on 5 October 1919.

**ENGLAND, LANCASHIRE, WIGAN, HAIGH**

Death of Frances (Fanny) Hadkin<sup>187</sup> in December 1858.

**ENGLAND, LANCASHIRE, WIGAN, STANDISHGATE**

Birth of Mary Woods<sup>252</sup> on 27 January 1758.

**ENGLAND, LANCASHIRE, WINSTANLEY**

Birth of Elizabeth Arrowsmith<sup>162</sup> about 1823.

**ENGLAND, LANCASTER, BOLTON, HALLIWEL RD CHAPEL**

Marriage of William Roorcroft<sup>146</sup> and Clara Talbot<sup>147</sup> on 30 June 1897.

**ENGLAND, LINCOLNSHIRE, 1670580**

Birth of Ann Batteram<sup>225</sup> in 1771.

Death of Ann Batteram<sup>225</sup> in September 1852.

**ENGLAND, LINCOLNSHIRE, BOURNE**

Death of Edith Templeman<sup>112</sup> in January 1925.

Death of Thomas Templeman<sup>135</sup> in October 1938.

**ENGLAND, LINCOLNSHIRE, CARLBY**

Birth of William Roy Templeman<sup>222</sup> in June 1769.

Birth of Louisa (Kate) Catherine Templeman<sup>110</sup> on 17 March 1881.

Birth of Edith Templeman<sup>112</sup> about 1899.

**ENGLAND, LINCOLNSHIRE, CARLBY, CARLBY**

Residence of Emma Templeman<sup>100</sup> in 1901.

Residence of Edith Templeman<sup>112</sup> in 1901.

Residence of Thomas Templeman<sup>135</sup> in 1901.

Residence of Jane Cobb<sup>136</sup> in 1901.

**ENGLAND, LINCOLNSHIRE, CARLBY, CARLBY, CARLBY**

Residence of Emma Templeman<sup>100</sup> in 1891.

Residence of Louisa (Kate) Catherine Templeman<sup>110</sup> in 1891.

**ENGLAND, LINCOLNSHIRE, MANTHORPE AND CARLBY**

Residence of Louisa (Kate) Catherine Templeman<sup>110</sup> in 1911.

Residence of Thomas Templeman<sup>135</sup> in 1911.

**ENGLAND, LINCOLNSHIRE, MARKET DEEPING**

Birth of Robert Templeman<sup>193</sup> on 8 November 1789.

Birth of Sarah Posnette<sup>183</sup> in January 1820.

Death of Robert Templeman<sup>193</sup> on 21 March 1850.

**ENGLAND, LINCOLNSHIRE, STAMFORD**

Death of Albert George Wakefield<sup>111</sup> in June 1950.

**ENGLAND, LINCOLNSHIRE, TALLINGTON**

Birth of Mary Reedman<sup>194</sup> in 1793.

**ENGLAND, LONDON, HACKNEY**

Birth of Catherine Jane Emerson<sup>10</sup> on 19 November 1992.

**ENGLAND, LONDON, ISLINGTON BROOKFIELD**

Death of Edward Walsh Roorcroft<sup>119</sup> on 19 September 1960.

**ENGLAND, LONDON, WESTMINSTER, LONDON ZOO**

Marriage of Michael Lee Slack<sup>9</sup> and Rachel Jane Watts<sup>8</sup> on 10 October 2015.

**ENGLAND, MANCHESTER**

Probate: Edward Roorcroft<sup>169</sup> on 7 March 1889.

**ENGLAND, MIDDLESEX, TWICKENHAM**

Residence of Paul Thomas O'Mara<sup>55</sup>.

**ENGLAND, NEWCASTLE-UPON-TYNE**

Death of William Atkinson<sup>240</sup> on 8 March 1847.

**ENGLAND, NORFOLK**

Death of William Stimson<sup>199</sup> in June 1867.

**ENGLAND, NORTH YORKSHIRE, YORK**

Residence of Sheila Sanderson<sup>88</sup>.

Residence of Sheila Sanderson<sup>88</sup> in 2014.

**ENGLAND, NORTHAMPTON, YARWELL**

Baptism of Ann Stimson<sup>180</sup> on 27 November 1814.

**ENGLAND, NORTHAMPTONSHIRE**

Birth of William Wm Payne<sup>228</sup> on 19 February 1759.

Birth of Elizabeth Leggin<sup>229</sup> about 1760.

Birth of Robert Allen<sup>195</sup> about 1780.

Baptism of John Stimson<sup>182</sup> on 27 July 1823.

**ENGLAND, NORTHAMPTONSHIRE, ALL HALLOWS, WELLINGBOROUGH**

Birth of William Cobb<sup>226</sup> in 1765.

**ENGLAND, NORTHAMPTONSHIRE, GARWELL**

Birth of John Stimson<sup>182</sup> in 1823.

**ENGLAND, NORTHAMPTONSHIRE, NASSINGTON**

Birth of Ann Norris<sup>231</sup> about 1775.

**ENGLAND, NORTHAMPTONSHIRE, WANSFORD**

Birth of Jane Anne Stimson<sup>160</sup> about 1856.

**ENGLAND, NORTHAMPTONSHIRE, WARKTON**

Birth of Rebecca Payne<sup>198</sup> on 28 October 1788.

Death of William Wm Payne<sup>228</sup> about 1819.

**ENGLAND, NORTHAMPTONSHIRE, WELLINGBOR**

Birth of Amos Cobb<sup>167</sup> in 1826.

**ENGLAND, NORTHAMPTONSHIRE, WELLINGBOROUGH**

Birth of John Cobb<sup>197</sup> about 1792.

Death of Elizabeth Berry<sup>227</sup> in January 1830.

Death of Rebecca Payne<sup>198</sup> on 26 February 1870.

**ENGLAND, NORTHAMPTONSHIRE, YARWELL**

Birth of Catherine Lattimore<sup>200</sup> in 1795.

Marriage of William Stimson<sup>199</sup> and Catherine Lattimore<sup>200</sup> on 11 July 1814.

Birth of Jane Stimson<sup>168</sup> about 1828.

**ENGLAND, NOTTINGHAMSHIRE, NOTTINGHAM**

Birth of Aileen Mary King<sup>123</sup> on 10 January 1906.

**ENGLAND, NOTTINGHAMSHIRE, SUTTON IN ASHFIELD**

Birth of Michael Lee Slack<sup>9</sup> on 3 March 1989.

**ENGLAND, RUTLAND, ESSENDINE**

Birth of Thomas Templeman<sup>135</sup> in 1857.

**ENGLAND, SOMERSET, LONG ASHTON**

Death of Sarah Posnette<sup>183</sup> in March 1900.

Death of John Stimson<sup>182</sup> in April 1902.

**ENGLAND, STAFFORDSHIRE, STAFFORD**

Death of Louisa (Kate) Catherine Templeman<sup>110</sup> in April 1972.

**ENGLAND, WARWICK, COVENTRY, SAINT JOHN**

Marriage of John Stimson<sup>182</sup> and Sarah Posnette<sup>183</sup> on 24 May 1863.

**ENGLAND, WARWICK, COVENTRY, ST THOMAS'**

Baptism of Jane Cobb<sup>136</sup> on 4 May 1856.

**ENGLAND, WARWICKSHIRE, COVENTRY**

Birth of Jane Cobb<sup>136</sup> in 1856.

**ENGLAND, WARWICKSHIRE, COVENTRY ST MICHAEL, ST THOMAS, COVENTRY**

Residence of Jane Cobb<sup>136</sup> in 1861.

**ENGLAND, WARWICKSHIRE, KINGS NORTON**

Death of Jane Anne Stimson<sup>160</sup> in January 1924.

**ENGLAND, WEST SUSSEX, BOGNOR REGIS**

Residence of John Marsden Roocroft<sup>89</sup>.

**ENGLAND, WESTMORELAND**

Birth of John Atkinson<sup>234</sup> in 1761.

**ENGLAND, WESTMORLAND, MILNTHORPE**

Birth of Catherine Charlotte Atkinson<sup>202</sup> on 9 December 1798.

**ENGLAND, YORKSHIRE, BURLEY**

Birth of Matthew Lofthouse<sup>175</sup> about 1838.

**ENGLAND, YORKSHIRE, BURTON**

Birth of Mary Ann Brayshaw<sup>204</sup> in February 1795.

**ENGLAND, YORKSHIRE, BURTON IN LONSDALE**

Birth of James Altham Batty<sup>203</sup> on 27 April 1798.

Death of Mary Ann Brayshaw<sup>204</sup> on 4 July 1856.

Death of William Brayshaw<sup>238</sup> on 4 July 1856.

**ENGLAND, YORKSHIRE, HORTON IN RIBBLESDALE**

Birth of Alice Downham<sup>239</sup> in 1764.

Birth of William Brayshaw<sup>238</sup> in October 1764.

**ENGLAND, YORKSHIRE, SETTLE**

Marriage of Edward Roocroft<sup>169</sup> and Mary Batty<sup>170</sup> in 1852.

**ENGLAND, YORKSHIRE, YORK**

Death of Sheila Sanderson<sup>88</sup> on 20 July 2016.

**GHANA**

Marriage of Richard Manu<sup>11</sup> and Catherine Jane Emerson<sup>10</sup> on 7 April 2018.

**GREATER LONDON, LEWISHAM**

Birth of Andrew P Jablonski<sup>60</sup> in October 1954.

**HAMPSHIRE, WINCHESTER**

Birth of Robert Cameron Jameson<sup>7</sup> on 10 August 1987.

**HORWICH**

Birth of Peter Marsden<sup>244</sup> on 5 June 1758.

**INVERNESS, RAIGMORE**

Birth of John Ross Jameson<sup>6</sup> on 16 May 1981.

**ISLE OF MAN**

Birth of Patrick Corris<sup>253</sup> in 1695.

Birth of Elizabeth Cowin<sup>190</sup> on 10 October 1773.

Birth of Simon Corris<sup>189</sup> in 1774.

**ISLE OF MAN (80), MICHAEL**

Death of Catherine Callister<sup>254</sup> in March 1758.

**ISLE OF MAN, GLENFABA, PATRICK**

Death of William Corris<sup>216</sup> on 7 March 1774.

**ISLE OF MAN, MICHAEL**

Death of Catherine Cubbon<sup>256</sup> in April 1740.

**ISLE OF MAN, MICHAEL, BALLAUGH**

Birth of William Cowley<sup>255</sup> in 1690.

Birth of Margaret Cowley<sup>217</sup> on 5 March 1720.

**ISLE OF MAN, MICHAEL, JURBY**

Birth of Catherine Cubbon<sup>256</sup> on 1 June 1687.

**ISLE OF MAN, PATRICK**

Burial of Patrick Corris<sup>253</sup> on 19 October 1785.

**LANCASHIRE**

Death of Robert Marsden<sup>210</sup> in 1835.

**LANCASHIRE ENGLAND**

Birth of Isabella Summers<sup>241</sup> in 1770.

**LANCASHIRE, BLACKBURN**

Death of George Harwood<sup>263</sup> about January 1794.

**LANCASHIRE, BLACKPOOL**

Birth of Ian Robert Jameson<sup>70</sup> in July 1970.

**LANCASHIRE, BOLTON**

Death of Albert Lord<sup>132</sup> on 10 May 1972.

Death of Elsie Marsden<sup>131</sup> on 6 January 1977.

Death of Mary (Polly) Elizabeth Marsden<sup>129</sup> on 29 August 1977.

Death of Edith Marsden<sup>128</sup> on 13 February 1980.

**LANCASHIRE, BOLTON, DEANE PARISH CHURCH**

Marriage of George Harwood<sup>263</sup> and Alice Taylor<sup>264</sup> on 2 January 1759.

**LANCASHIRE, BOLTON, HALLIWELL**

Birth of John Harwood<sup>250</sup> about 1779.

**LANCASHIRE, BOLTON, HEATON**

Birth of Ann (Nancy) Harwood<sup>245</sup> in 1759.

Death of John Harwood<sup>248</sup> about January 1770.

**LANCASHIRE, CROSTON**

Birth of John Roccroft<sup>232</sup> on 16 March 1757.

**LANCASHIRE, CROSTON, ULNES WALTON**

Death of James Roccroft<sup>257</sup> on 29 October 1763.

Death of John Roccroft<sup>232</sup> on 4 December 1801.

**LANCASHIRE, DEANE**

Birth of Alice Taylor<sup>264</sup> in 1725.

**LANCASHIRE, FARNWORTH**

Birth of Margaret Jameson<sup>48</sup> on 14 October 1940.

Birth of Susan D Jameson<sup>50</sup> in January 1947.

Birth of Sheila Anne Jameson<sup>62</sup> in October 1954.

Birth of David J Roccroft<sup>71</sup> on 26 August 1958.

Birth of Elizabeth H Jameson<sup>67</sup> in January 1964.

Birth of Angela Ruth Jameson<sup>68</sup> in October 1968.

**LANCASHIRE, FYLDE**

Death of Jane Hodson<sup>174</sup> in July 1911.

**LANCASHIRE, HALLIWELL**

Death of Ann (Nancy) Harwood<sup>245</sup> on 26 February 1817.  
 Death of Peter Marsden<sup>244</sup> on 5 December 1825.

**LANCASHIRE, OF WIGAN**

Birth of Margaret Unknown<sup>266</sup> in 1728.

**LANCASHIRE, PRESCOT**

Death of Linda Marsden Atkinson<sup>120</sup> on 4 April 1951.  
 Birth of Carolyn Anne Harwood<sup>73</sup> in April 1962.  
 Birth of Judith Harwood<sup>75</sup> in January 1964.

**LANCASHIRE, ROCHDALE**

Death of Mary Bibby<sup>211</sup> in April 1873.

**LANCASHIRE, STANDISH**

Birth of Margaret Lyptrott<sup>262</sup> on 18 July 1742.  
 Death of Margaret Lyptrott<sup>262</sup> on 22 May 1781.

**LANCASHIRE, ULNES WALTON**

Birth of James Roorcroft<sup>257</sup> on 21 October 1725.

**LANCASHIRE, WIGAN**

Residence of Margaret Jameson<sup>214</sup>.  
 Death of Peter Jameson<sup>186</sup> on 16 January 1875.

**LANCASHIRE, WIGAN, STANDISHGATE**

Death of Margaret Unknown<sup>266</sup> on 6 November 1801.

**LANCS, LEYLAND**

Death of Sarah Johnson<sup>258</sup> in February 1809.

**LANCS, ULNES WALTON**

Birth of Sarah Johnson<sup>258</sup> in June 1731.

**LANGTOFT LINCOLNSHIRE**

Death of Robert Reedman<sup>224</sup> in January 1851.

**LINCOLN, CARLBY**

Birth of Amos Stimson Templeman<sup>108</sup> in 1879.  
 Birth of Emma Templeman<sup>100</sup> on 26 May 1888.

**LINCOLNSHIRE, BOURNE**

Birth of Audrey Templeman<sup>91</sup> in April 1921.

**LINCOLNSHIRE, MARKET DEEPING**

Birth of William Templeman<sup>165</sup> in December 1822.

**LLANDUDNO**

Probate: Edward Dennis Jameson<sup>83</sup> on 16 November 1944.

**LONDON, WANDSWORTH**

Birth of Jason Andrew O'Mara<sup>28</sup> in October 1970.  
 Birth of Craig Antony O'Mara<sup>29</sup> in October 1973.

**MANCHESTER, WITHINGTON HOSPITAL**

Death of John Corris Jameson<sup>81</sup> on 4 November 1976.

**MIDDLESEX, UXBRIDGE**

Birth of Janina M A Jablonski<sup>56</sup> in October 1949.  
 Birth of Dennis C Jablonski<sup>58</sup> in July 1952.

**NEWTON IN LONSDALE**

Birth of Mary Batty<sup>170</sup> about 1834.

**NORTHUMBERLAND, NEWCASTLE UPON TYNE**

Birth of Sally Emerson<sup>43</sup> on 21 July 1953.

**PATRICK ISLE OF MAN**

Death of Margaret Cowley<sup>217</sup> on 29 September 1783.

Death of Simon Corris<sup>189</sup> on 31 December 1841.

**PICKWORTH RUTLAND**

Birth of Katherine Sargeant<sup>109</sup> in 1879.

**PILLING LANCASHIRE**

Birth of Elizabeth Higginson<sup>268</sup> in 1715.

Birth of Mary Whiteside<sup>260</sup> in 1740.

**RUTLAND, ESSENDINE**

Birth of Ann Allen<sup>166</sup> in June 1814.

**SCOTLAND, BLACK ISLE**

Residence of Andrew John Jameson<sup>40</sup> in January 1977.

**SCOTLAND, EAST LOTHIAN, NORTH BERWICK**

Residence of Andrew John Jameson<sup>40</sup> in June 1995.

**SCOTLAND, PERTSHIRE, ALYTH**

Residence of Andrew John Jameson<sup>40</sup> on 21 October 2021.

Death of Jane Elizabeth Woods<sup>42</sup> on 27 September 2024.

**SCOTLAND, ROSS-SHIRE, CONTIN**

Marriage of Andrew John Jameson<sup>40</sup> and Jane Elizabeth Woods<sup>42</sup> on 19 May 2018.

**SCOTLAND, STORNOWAY**

Residence of Andrew John Jameson<sup>40</sup> in September 1975.

**SOMERSET, WELLS**

Birth of Catherine R Warmington<sup>53</sup> in April 1948.

**SPAIN, CANTABRIA, SANTANDER**

Birth of Nicholas Camblor Jameson<sup>13</sup> on 10 February 1988.

Birth of Mateo Camblor Jameson<sup>14</sup> on 13 March 1991.

Birth of Sofia Camblor Jameson<sup>15</sup> on 13 September 1993.

Birth of Linda Camblor Jameson<sup>16</sup> on 2 November 1995.

**SPAIN, CANTABRIA, SANTANDER PROVINCE, PECHON**

Address: Jane Elizabeth Woods<sup>42</sup> in 2009.

**SPAIN, CANTABRIA, SANTANDER PROVINCE, PECHÓN**

Hoshika - Our Shiba Inu (D.O.B. : 12 September 2014) Breeder : Jaquelin / Raquel Rodríguez, Amatsu Kami,

Cartagena, Murcia, Spain): Jane Elizabeth Woods<sup>42</sup> on 12 September 2014.

**SPAIN, MADRID**

Birth of Roberto Camblor Jameson<sup>12</sup> on 26 March 1986.

**SPAIN, PECHÓN**

Address: Andrew John Jameson<sup>40</sup> in 2009.

Residence of Andrew John Jameson<sup>40</sup> in 2014.

**STAFFORDSHIRE, STOKE**

Birth of Judith Anne Whitehurst<sup>41</sup> in May 1954.

**STALMINE LANCASHIRE ENGLAND**

Birth of William Atkinson<sup>240</sup> on 20 February 1769.

**SURREY, SURREY SOUTH WESTERN**

Birth of Scott McLaren<sup>30</sup> in April 1978.

Birth of Amy McLaren<sup>31</sup> in January 1980.

**TALLINGTON WEST DEEPING LINCOLNSHIRE**

Birth of Robert Reedman<sup>224</sup> on 4 April 1770.

**UNITED KINGDOM, CHESHIRE, WARRINGTON**

Marriage of Stephen Bailey<sup>74</sup> and Carolyn Anne Harwood<sup>73</sup> in 1994.

**UNITED KINGDOM, CUMBRIA, WHITEHAVEN**

Marriage of David A B Potts<sup>69</sup> and Angela Ruth Jameson<sup>68</sup> in 2000.

**UNITED KINGDOM, DERBYSHIRE, HIGH PEAK**

Marriage of Andrew P Jablonski<sup>60</sup> and Anne J Crawley<sup>61</sup> in July 1976.

**UNITED KINGDOM, DURHAM, DURHAM NORTHERN**

Marriage of James Richard Somersall<sup>26</sup> and Paula Elizabeth Anderson<sup>27</sup> in 2002.

**UNITED KINGDOM, ENGLAND, CAMBRIDGESHIRE**

Death of Edward Green Lattimore<sup>230</sup> about 1830.

**UNITED KINGDOM, ENGLAND, CHESHIRE, ROCK FERRY**

Death of Jane Harrison<sup>164</sup> on 7 November 1878.

**UNITED KINGDOM, ENGLAND, DERBYSHIRE, DERBY**

Residence of Andrew P Jablonski<sup>60</sup> '2003–2007'.

**UNITED KINGDOM, ENGLAND, DURHAM, DURHAM**

Residence of Paula Elizabeth Anderson<sup>27</sup> '2003–2010'.

**UNITED KINGDOM, ENGLAND, HAMPSHIRE, ANDOVER**

Residence of John Ross Jameson<sup>6</sup> in 2007.

**UNITED KINGDOM, ENGLAND, LANCASHIRE**

Residence of Eric Talbot Roocroft<sup>122</sup> in 1940.

**UNITED KINGDOM, ENGLAND, LANCASHIRE, CHORLEY**

Residence of Jane Elizabeth Woods<sup>42</sup> '2004–2010'.

Residence of Rachel Jane Watts<sup>8</sup> '2008–2010'.

**UNITED KINGDOM, ENGLAND, LANCASHIRE, PRESTON**

Death of Catherine Charlotte Atkinson<sup>202</sup> on 31 December 1866.

**UNITED KINGDOM, ENGLAND, LANCASHIRE, THORNTON-CLEVELEYS**

Residence of Sheila Sanderson<sup>88</sup> '2004–2006'.

**UNITED KINGDOM, ENGLAND, NORTHAMPTONSHIRE COUNTY**

Birth of Edward Green Lattimore<sup>230</sup> about 1775.

**UNITED KINGDOM, ENGLAND, SHROPSHIRE, TELFORD**

Residence of Michael Lee Slack<sup>9</sup> '2007–2008'.

**UNITED KINGDOM, GREATER LONDON, BROMLEY**

Marriage of Robin Marcus Wardle<sup>21</sup> and Elizabeth J Stone<sup>22</sup> in 1992.

**UNITED KINGDOM, HAMPSHIRE, ANDOVER**

Marriage of John E Jablonski<sup>52</sup> and Catherine R Warmington<sup>53</sup> in January 1973.

**UNITED KINGDOM, ISLE OF MAN**

Death of Elizabeth Cowin<sup>190</sup> on 13 June 1852.

**UNITED KINGDOM, ISLE OF MAN, ISLE OF MAN, GLENFABA, PATRICK**

Birth of Edward Corris<sup>163</sup> in January 1815.

**UNITED KINGDOM, ISLE OF MAN, ISLE OF MAN, MICHAEL**

Birth of Catherine Callister<sup>254</sup> on 27 September 1695.

**UNITED KINGDOM, ISLE OF WIGHT, ISLE OF WIGHT**

Marriage of Timothy James Wardle<sup>24</sup> and Jacqueline A Thornes<sup>25</sup> in 2004.

**UNITED KINGDOM, KENT, CHATHAM**

Marriage of Paul Thomas O'Mara<sup>55</sup> and Edwina M Jablonski<sup>54</sup> in July 1969.  
 Marriage of Dennis C Jablonski<sup>58</sup> and Laura E Slater<sup>59</sup> in July 1983.

**UNITED KINGDOM, KENT, MAIDSTONE**

Marriage of Neil McLaren<sup>57</sup> and Janina M A Jablonski<sup>56</sup> in April 1973.

**UNITED KINGDOM, LANCASHIRE**

Marriage of Edward Corris<sup>163</sup> on 6 September 1838.  
 Death of Elizabeth McAlpine<sup>206</sup> in June 1852.  
 Death of James Ashburn<sup>205</sup> in March 1875.  
 Death of Jane Corris Jameson<sup>104</sup> in September 1886.  
 Death of Robert Marsden<sup>155</sup> in December 1904.

**UNITED KINGDOM, LANCASHIRE, BLACKPOOL & FYLDE**

Marriage of Philip Booth<sup>63</sup> and Sheila Anne Jameson<sup>62</sup> in April 1980.

**UNITED KINGDOM, LANCASHIRE, BOLTON**

Marriage of Thomas Marsden<sup>126</sup> and Lucy Pendlebury<sup>127</sup> in July 1902.

**UNITED KINGDOM, LANCASHIRE, WIGAN**

Death of Elizabeth Arrowsmith<sup>162</sup> in August 1898.

**UNITED KINGDOM, LINCOLNSHIRE**

Death of Mary Reedman<sup>194</sup> in June 1883.  
 Death of Jane Cobb<sup>136</sup> in June 1902.

**UNITED KINGDOM, LINCOLNSHIRE, BOURNE**

Marriage of Thomas Templeman<sup>135</sup> in July 1878.  
 Marriage of Albert George Wakefield<sup>111</sup> and Louisa (Kate) Catherine Templeman<sup>110</sup> in October 1916.

**UNITED KINGDOM, LINCOLNSHIRE, STAMFORD**

Birth of Albert George Wakefield<sup>111</sup> on 12 March 1884.  
 Marriage of Amos Stimson Templeman<sup>108</sup> in April 1901.

**UNITED KINGDOM, MERSEYSIDE, ST. HELENS**

Marriage of Ian J Brown<sup>76</sup> and Judith Harwood<sup>75</sup> in 1989.

**UNITED KINGDOM, MIDDLESEX, WESTMINSTER**

Marriage of Janik Jablonski<sup>85</sup> and Brenda Jameson<sup>84</sup> on 24 October 1944.

**UNITED KINGDOM, NORTHAMPTONSHIRE, HUNTINGDONSHIRE, STAMFORD**

Death of Catherine Lattimore<sup>200</sup> in April 1867.

**UNITED KINGDOM, NORTHAMPTONSHIRE, WELLINGBOROUGH**

Death of John Cobb<sup>197</sup> in October 1872.

**UNITED KINGDOM, WEST MIDLANDS, WARWICKSHIRE, COVENTRY**

Death of Jane Stimson<sup>168</sup> in January 1901.

**UNITED KINGDOM, YORKSHIRE WEST RIDING**

Death of Alice Downham<sup>239</sup> in June 1840.

**VILNA POLAND**

Birth of Janik Jablonski<sup>85</sup> on 24 October 1912.

**WARWICKSHIRE, WARWICK**

Death of Amos Cobb<sup>167</sup> in 1888.

**WESTHOUGHTON BOLTON LANCASHIRE 8C / 219**

Birth of Amy Ann Woodward<sup>159</sup> in 1862.

**WESTMORLAND**

Death of Katharine Prickett<sup>235</sup> in December 1852.

**WESTMORLAND, WITHERSLACK, LOW WOOD**

Birth of Katharine Prickett<sup>235</sup> on 25 May 1763.

**WIGAN LANCASHIRE ENGLAND**

Birth of James Jameson<sup>265</sup> about 1723.

Death of Mary Woods<sup>252</sup> on 18 March 1807.

Death of James Jameson<sup>251</sup> on 4 January 1830.

**YORKSHIRE WEST RIDING, DONCASTER**

Death of Thomas Marsden<sup>176</sup> in January 1906.

**YORKSHIRE WEST RIDING, WAKEFIELD**

Death of James Altham Batty<sup>203</sup> in October 1878.

**YORKSHIRE, BURTON IN LONSDALE**

Birth of Thomas Batty<sup>236</sup> on 27 May 1751.

**8. INDEX OF DATES**

- 1687**  
Birth of Catherine Cubbon<sup>256</sup> on 1 June, in Jurby, Michael, Isle of Man.
- 1690**  
Birth of William Cowley<sup>255</sup> in Ballaugh, Michael, Isle of Man.
- 1692**  
Birth of Peter Marsden<sup>269</sup> in about 1692, in Standish, Lancashire, England.
- 1695**  
Birth of Patrick Corris<sup>253</sup> in Isle of Man.  
Birth of Catherine Callister<sup>254</sup> on 27 September, in Michael, Isle of Man, Isle of Man, United Kingdom.  
Birth of Anne Robinson<sup>270</sup> in about 1695, in Standish, Lancashire, England.
- 1711**  
Birth of Timothy Atkinson<sup>267</sup> in St Michael on Wyre, Lancashire, England.
- 1715**  
Birth of Elizabeth Higginson<sup>268</sup> in Pilling Lancashire.
- 1717**  
Marriage of Peter Marsden<sup>269</sup> and Anne Robinson<sup>270</sup> on 23 April, in Wigan, All Saints, Lancashire, England.
- 1719**  
Birth of Joshua Marsden<sup>261</sup> in about 1719, in Standish, Lancashire, England.
- 1720**  
Birth of Margaret Cowley<sup>217</sup> on 5 March, in Ballaugh, Michael, Isle of Man.  
Birth of William Corris<sup>216</sup> in Kirk German, Isle of Man, England.
- 1723**  
Birth of James Jameson<sup>265</sup> in about 1723, in Wigan Lancashire England.
- 1725**  
Birth of Alice Taylor<sup>264</sup> in Deane, Lancashire.  
Birth of James Roorcroft<sup>257</sup> on 21 October, in Ulnes Walton, Lancashire.
- 1728**  
Birth of Margaret Unknown<sup>266</sup> in of Wigan, Lancashire.
- 1730**  
Birth of George Harwood<sup>263</sup> in Bolton, Lancashire, England.
- 1731**  
Birth of Sarah Johnson<sup>258</sup> in June, in Ulnes Walton, Lancs.
- 1739**  
Birth of John Atkinson<sup>259</sup> in Pilling, Lancashire, England.
- 1740**  
Death of Catherine Cubbon<sup>256</sup> in April, in Michael, Isle of Man.  
Birth of Mary Whiteside<sup>260</sup> in Pilling Lancashire.
- 1742**  
Birth of Margaret Lyptrott<sup>262</sup> on 18 July, in Standish, Lancashire.
- 1743**  
Christening of James Jameson<sup>251</sup> on 25 March, in Wigan, Lancashire, England.  
Baptism of James Jameson<sup>251</sup> on 25 March, in Wigan, All Saints, Lancashire, England.  
Birth of James Jameson<sup>251</sup> in Wigan, Lancashire, England.
- 1744**  
Marriage of William Corris<sup>216</sup> and Margaret Cowley<sup>217</sup> on 14 August, in Patrick, Isle of Man, England.
- 1749**  
Birth of Jane Middleton<sup>221</sup> on 5 September, in Upton by Birkenhead, Cheshire, England.
- 1750**  
Death of Anne Robinson<sup>270</sup> in May, in Standish, Lancashire, England.
- 1751**  
Birth of Thomas Batty<sup>236</sup> on 27 May, in Burton in Lonsdale, Yorkshire.
- 1752**  
Birth of Thomas Oxton<sup>220</sup> in about 1752, in West Kirby, Cheshire, England.
- 1753**  
Marriage of Joshua Marsden<sup>261</sup> and Margaret Lyptrott<sup>262</sup> on 5 March, in Standish, Lancashire, England.  
Birth of Elizabeth Clague<sup>219</sup> in about 1753.  
Birth of Thomas Cowin<sup>218</sup> in about 1753.
- 1757**  
Birth of John Roorcroft<sup>232</sup> on 16 March, in Croston, Lancashire.  
Birth of Elizabeth Moore<sup>237</sup> on 12 June, in Linton, Cambridgeshire, England.
- 1758**  
Birth of Mary Woods<sup>252</sup> on 27 January, in Standishgate, Wigan, Lancashire, England.  
Death of Catherine Callister<sup>254</sup> in March, in Michael, Isle of Man (80).  
Birth of Peter Marsden<sup>244</sup> on 5 June, in Horwich.

- 1759**  
 Marriage of George Harwood<sup>263</sup> and Alice Taylor<sup>264</sup> on 2 January, in Deane Parish Church, Bolton, Lancashire.  
 Birth of William Wm Payne<sup>228</sup> on 19 February, in Northamptonshire, England.  
 Birth of Ann (Nancy) Harwood<sup>245</sup> in Heaton, Bolton, Lancashire.  
 Birth of Elizabeth Berry<sup>227</sup>.
- 1760**  
 Birth of Elizabeth Leggin<sup>229</sup> in about 1760, in Northamptonshire, England.
- 1761**  
 Birth of John Atkinson<sup>234</sup> in Westmoreland, England.  
 Birth of Robert Harwood<sup>246</sup> in Heaton, Deane, Bolton.
- 1762**  
 Birth of Elizabeth Rigby<sup>233</sup> in Upholland, Lancashire, England.
- 1763**  
 Birth of Katharine Prickett<sup>235</sup> on 25 May, in Low Wood, Witherslack, Westmorland.  
 Death of James Roorcroft<sup>257</sup> on 29 October, in Ulnes Walton, Croston, Lancashire.
- 1764**  
 Birth of Alice Downham<sup>239</sup> in Horton In Ribblesdale, Yorkshire, England.  
 Birth of William Brayshaw<sup>238</sup> in October, in Horton In Ribblesdale, Yorkshire, England.
- 1765**  
 Birth of William Cobb<sup>226</sup> in Wellingborough, All Hallows, Northamptonshire, England.  
 Birth of Betty Mary Schwab<sup>223</sup>.  
 Death of Peter Marsden<sup>269</sup> in Standish, Lancashire, England.
- 1766**  
 Birth of George Harwood<sup>247</sup> in Heaton, Deane, Bolton.  
 Birth of John Harwood<sup>248</sup> in about 1766, in Heaton, Deane, Bolton.
- 1768**  
 Birth of Thomas Wright<sup>242</sup> in Lancashire, England.
- 1769**  
 Birth of William Atkinson<sup>240</sup> on 20 February, in Stalmine Lancashire England.  
 Birth of William Roy Templeman<sup>222</sup> in June, in Carlby, Lincolnshire, England.  
 Marriage of Peter Marsden<sup>244</sup> and Ann (Nancy) Harwood<sup>245</sup> on 12 August, in Prestbury, Cheshire, England.  
 Birth of Peggy (Margaret) Huntington<sup>243</sup> in November, in Nateby, Lancashire, England.  
 Birth of Richard Harrison<sup>191</sup> in about 1769, in Thurstaton, Cheshire, England.
- 1770**  
 Birth of Robert Reedman<sup>224</sup> on 4 April, in Tallington West Deeping Lincolnshire.  
 Birth of Isabella Summers<sup>241</sup> in Lancashire England.  
 Death of John Harwood<sup>248</sup> in about January, in Heaton, Bolton, Lancashire.
- 1771**  
 Birth of Ann Batteram<sup>225</sup> in 1670580, Lincolnshire, England.
- 1773**  
 Birth of Elizabeth Cowin<sup>190</sup> on 10 October, in Isle of Man.
- 1774**  
 Death of William Corris<sup>216</sup> on 7 March, in Patrick, Glenfaba, Isle of Man.  
 Birth of Simon Corris<sup>189</sup> in Isle of Man.
- 1775**  
 Birth of Ann Norris<sup>231</sup> in about 1775, in Nassington, Northamptonshire, England.  
 Birth of Edward Green Lattimore<sup>230</sup> in about 1775, in Northamptonshire County, England, United Kingdom.
- 1776**  
 Birth of Alice Harwood<sup>249</sup> in about 1776, in Halliwell, Deane.
- 1777**  
 Marriage of James Jameson<sup>251</sup> and Mary Woods<sup>252</sup> on 21 September, in Upholland, St Thomas, Lancashire, England.
- 1779**  
 Birth of Margaret Jameson<sup>214</sup> on 26 August, in Wigan, Lancashire, England.  
 Baptism of Margaret Jameson<sup>214</sup> on 11 September, in Wigan, Lancashire, England.  
 Birth of John Harwood<sup>250</sup> in about 1779, in Halliwell, Bolton, Lancashire.
- 1780**  
 Marriage(?) of Peter Marsden<sup>244</sup> and Ann (Nancy) Harwood<sup>245</sup> on 13 September, in St Peter, Bolton-Le-Moors, Lancashire, England.  
 Birth of Ann Briggs<sup>196</sup> in about 1780.  
 Birth of Robert Allen<sup>195</sup> in about 1780, in Northamptonshire, England.  
 Birth of Mary Oxtan<sup>192</sup> in about 1780, in Greasby, Cheshire, England.
- 1781**  
 Death of Margaret Lyptrott<sup>262</sup> on 22 May, in Standish, Lancashire.
- 1783**  
 Death of Margaret Cowley<sup>217</sup> on 29 September, in Patrick Isle Of Man.

- 1784**  
Birth of John Bolton<sup>212</sup> in about 1784, in Wigan, Lancashire, England.
- 1785**  
Birth of Richard Rookcroft<sup>201</sup> on 24 January, in Ulnes Walton, Lancashire, England.  
Death of Patrick Corris<sup>253</sup>.  
Burial of Patrick Corris<sup>253</sup> on 19 October, in Patrick, Isle of Man.
- 1788**  
Birth of Rebecca Payne<sup>198</sup> on 28 October, in Warkton, Northamptonshire, England.
- 1789**  
Birth of Robert Templeman<sup>193</sup> on 8 November, in Market Deeping, Lincolnshire, England.
- 1790**  
Birth of Robert Marsden<sup>210</sup> on 3 September, in Dean, Lancashire, England.  
Baptism of Robert Marsden<sup>210</sup> on 29 September, in Horwich, Lancashire, England.
- 1792**  
Birth of Christopher Atkinson<sup>207</sup> in Stalmine, Lancashire, England.  
Birth of John Cobb<sup>197</sup> in about 1792, in Wellingborough, Northamptonshire, England.
- 1793**  
Birth of Mary Reedman<sup>194</sup> in Tallington, Lincolnshire, England.
- 1794**  
Marriage of Simon Corris<sup>189</sup> and Elizabeth Cowin<sup>190</sup> on 16 November, in Kirk German, Isle of Man, England.  
Death of George Harwood<sup>263</sup> in about January, in Blackburn, Lancashire.
- 1795**  
Birth of Mary Ann Brayshaw<sup>204</sup> in February, in Burton, Yorkshire, England.  
Birth of Catherine Lattimore<sup>200</sup> in Yarwell, Northamptonshire, England.  
Birth of William Stimson<sup>199</sup> in Stibbington, Huntingdonshire, England.  
Death of Betty Mary Schwab<sup>223</sup> in about 1795.
- 1797**  
Birth of Mary Bibby<sup>211</sup> in Levenshulme, Lancashire, England.
- 1798**  
Birth of James Altham Batty<sup>203</sup> on 27 April, in Burton in Lonsdale, Yorkshire, England.  
Birth of Catherine Charlotte Atkinson<sup>202</sup> on 9 December, in Milnthorpe, Westmorland, England.
- 1799**  
Marriage of William Gaskell<sup>215</sup> and Margaret Jameson<sup>214</sup> on 1 April, in Wigan, All Saints, Lancashire, England.  
Birth of Mary Wright<sup>208</sup> in about August, in Cabus, Lancashire, England.
- 1800**  
Birth of Peter Jameson<sup>186</sup> on 22 September, in Wigan, Lancashire, England.  
Baptism of Peter Jameson<sup>186</sup> on 13 October, in Wigan, All Saints, Lancashire, England.  
Birth of Frances (Fanny) Hadkin<sup>187</sup> in about 1800, in Wigan, Lancashire, England.
- 1801**  
Death of Margaret Unknown<sup>266</sup> on 6 November, in Standishgate, Wigan, Lancashire.  
Death of John Rookcroft<sup>232</sup> on 4 December, in Ulnes Walton, Croston, Lancashire.
- 1802**  
Death of John Atkinson<sup>259</sup> before 24 June.
- 1805**  
Birth of James Ashburn<sup>205</sup> in about 1805, in Manchester, Lancashire, England.
- 1807**  
Death of Mary Woods<sup>252</sup> on 18 March, in Wigan Lancashire England.  
Death of Ann Norris<sup>231</sup> in about 1807.
- 1809**  
Death of Sarah Johnson<sup>258</sup> in February, in Leyland, Lancs.
- 1814**  
Birth of Ann Allen<sup>166</sup> in June, in Essendine, Rutland.  
Birth of Ann Stimson<sup>180</sup>.  
Death of Elizabeth Rigby<sup>233</sup> in Croston, Chorley, Lancashire, England.  
Marriage of William Stimson<sup>199</sup> and Catherine Lattimore<sup>200</sup> on 11 July, in Yarwell, Northamptonshire, England.  
Baptism of Ann Stimson<sup>180</sup> on 27 November, in Yarwell, Northampton, England.
- 1815**  
Birth of Edward Corris<sup>163</sup> in January, in Patrick, Glenfaba, Isle of Man, Isle of Man, United Kingdom.  
Death of Joshua Marsden<sup>261</sup> in about 1815.
- 1816**  
Birth of Jane Harrison<sup>164</sup> on 20 December, in Tranmere, Cheshire, England.  
Birth of Elizabeth McAlpine<sup>206</sup> in about 1816, in Manchester, Lancashire, England.
- 1817**  
Death of Ann (Nancy) Harwood<sup>245</sup> on 26 February, in Halliwell, Lancashire.

- 1818**  
 Death of Elizabeth Moore<sup>237</sup> in January, in Cherry Hinton.  
 Death of Margaret Jameson<sup>214</sup> in October.
- 1819**  
 Birth of Sarah Hodson<sup>209</sup> in Bolton, Lancashire, England.  
 Death of William Wm Payne<sup>228</sup> in about 1819, in Warkton, Northamptonshire, England.
- 1820**  
 Birth of Sarah Posnette<sup>183</sup> in January, in Market Deeping, Lincolnshire, England.  
 Marriage of Christopher Atkinson<sup>207</sup> and Mary Wright<sup>208</sup> on 20 March, in Garstang, Lancashire, England.  
 Marriage of Peter Jameson<sup>186</sup> and Frances (Fanny) Hadkin<sup>187</sup> on 4 June, in Saint Peter, Bolton Le Moors, Lancashire, England.
- 1822**  
 Birth of William Templeman<sup>165</sup> in December, in Market Deeping, Lincolnshire.
- 1823**  
 Birth of John Stimson<sup>182</sup> in Garwell, Northamptonshire, England.  
 Baptism of John Stimson<sup>182</sup> on 27 July, in Northamptonshire, England.  
 Birth of Elizabeth Arrowsmith<sup>162</sup> in about 1823, in Winstanley, Lancashire, England.  
 Death of John Atkinson<sup>234</sup> in about 1823.
- 1824**  
 Birth of Sarah Bolton<sup>184</sup> in about 1824, in Bolton, Lancashire, England.  
 Birth of William Jameson<sup>161</sup> in about 1824, in Wigan, Lancashire, England.
- 1825**  
 Death of Peter Marsden<sup>244</sup> on 5 December, in Halliwell, Lancashire.
- 1826**  
 Birth of Amos Cobb<sup>167</sup> in Wellingbor, Northamptonshire, England.
- 1827**  
 Birth of Hannah Bolton<sup>185</sup>.  
 Birth of Elizabeth (Betty) Bolton<sup>177</sup> in Bolton, Lancashire, England.
- 1828**  
 Birth of Thomas Marsden<sup>176</sup> in Chorley, Lancashire, England.  
 Death of Thomas Batty<sup>236</sup>.  
 Birth of Jane Stimson<sup>168</sup> in about 1828, in Yarwell, Northamptonshire, England.
- 1830**  
 Death of James Jameson<sup>251</sup> on 4 January, in Wigan Lancashire England.  
 Burial of James Jameson<sup>251</sup> on 6 January, in Wigan, All Saints, Lancashire, England.  
 Death of Elizabeth Berry<sup>227</sup> in January, in Wellingborough, Northamptonshire, England.  
 Birth of Edward Roorcroft<sup>169</sup> in Cartmel, Lancashire, England.  
 Death of Edward Green Lattimore<sup>230</sup> in about 1830, in Cambridgeshire, England, United Kingdom.
- 1833**  
 Birth of James Atkinson<sup>173</sup> in Garstang, Lancashire, England.
- 1834**  
 Birth of Mary Batty<sup>170</sup> in about 1834, in Newton in Lonsdale.
- 1835**  
 Death of Robert Marsden<sup>210</sup> in Lancashire.  
 Death of Sarah Hodson<sup>209</sup> on 21 October, in Bolton, Lancashire, England.  
 Marriage of James Ashburn<sup>205</sup> and Elizabeth McAlpine<sup>206</sup> on 17 November, in Manchester, Lancashire, England.
- 1837**  
 Birth of Thomas Walsh Best<sup>171</sup> in Bolton, Lancashire, England.  
 Baptism of Thomas Walsh Best<sup>171</sup> on 13 August, in Bolton-le-Moors, St Peter, Lancashire, England.
- 1838**  
 Marriage of Edward Corris<sup>163</sup> on 6 September, in Lancashire, United Kingdom.  
 Marriage of Edward Corris<sup>163</sup> and Jane Harrison<sup>164</sup> on 6 September, in Liverpool, St Peter, Lancashire, England.  
 Birth of Jane Jameson<sup>178</sup> in about 1838, in Haigh, Lancashire, England.  
 Birth of Matthew Lofthouse<sup>175</sup> in about 1838, in Burley, Yorkshire, England.
- 1839**  
 Birth of Mary Ann Ashburn<sup>172</sup> in Bolton, Lancashire, England.  
 Birth of Jane Hodson<sup>174</sup> on 15 July, in Bolton, Lancashire, England.  
 Death of George Harwood<sup>247</sup> in December, in Bolton Lancashire 21 / 122.
- 1840**  
 Death of Alice Downham<sup>239</sup> in June, in Yorkshire West Riding, United Kingdom.
- 1841**  
 Residence of Robert Marsden<sup>210</sup> in Crumpsall, Manchester, Lancashire, England.  
 Death of Simon Corris<sup>189</sup> on 31 December, in Patrick Isle Of Man.
- 1842**  
 Death of Thomas Oxton<sup>220</sup> in June, in Storeton, Cheshire, England.

- 1844**  
Marriage of William Jameson<sup>161</sup> and Elizabeth Arrowsmith<sup>162</sup> on 19 February, in St John the Divine, Pemberton, Lancashire, England.
- 1845**  
Birth of Peter Jameson<sup>179</sup> in Haigh, Lancashire, England.  
Birth of Ellen Jameson<sup>141</sup> in September, in Wigan, Lancashire, England.  
Death of Richard Harrison<sup>191</sup> in about 1845, in Lower Tranmere, Cheshire, England.
- 1846**  
Birth of Mary Elizabeth Corris<sup>134</sup> in September, in Tranmere, Cheshire, England.
- 1847**  
Death of William Atkinson<sup>240</sup> on 8 March, in Newcastle-Upon-Tyne, England.
- 1849**  
Birth of William Thomas Marsden<sup>153</sup> in Oswaldtwistle, Lancashire, England.
- 1850**  
Death of Robert Templeman<sup>193</sup> on 21 March, in Market Deeping, Lincolnshire, England.  
Death of Thomas Wright<sup>242</sup> in May, in Garstang, Lancashire, England.  
Marriage(?) of James Ashburn<sup>205</sup> and Elizabeth McAlpine<sup>206</sup> on 19 June, in Manchester, St Mary, St Denys and St George, Lancashire, England.  
Birth of John Jameson<sup>133</sup> in Haigh, Lancashire, England.
- 1851**  
Death of Robert Reedman<sup>224</sup> in January, in Langtoft Lincolnshire.  
Residence of Peter Jameson<sup>186</sup> in Haigh, Lancashire, England.  
Residence of Elizabeth (Betty) Bolton<sup>177</sup> in Sharples, Lancashire, England.  
Residence of John Bolton<sup>212</sup> in Sharples, Lancashire, England.
- 1852**  
Death of Elizabeth Cowin<sup>190</sup> on 13 June, in Isle of Man, United Kingdom.  
Death of Elizabeth McAlpine<sup>206</sup> in June, in Lancashire, United Kingdom.  
Marriage of Edward Roorcroft<sup>169</sup> and Mary Batty<sup>170</sup> in Settle, Yorkshire, England.  
Death of Ann Batteram<sup>225</sup> in September, in 1670580, Lincolnshire, England.  
Death of Katharine Prickett<sup>235</sup> in December, in Westmorland.
- 1853**  
Birth of James Marsden<sup>154</sup> in Great Harwood, Lancashire, England.
- 1855**  
Birth of Martha Wilkinson<sup>156</sup> in Blackburn, Lancashire, England.  
Birth of Mary Jameson<sup>142</sup> in about 1855, in Wigan, Lancashire, England.
- 1856**  
Baptism of Jane Cobb<sup>136</sup> on 4 May, in St Thomas', Coventry, Warwick, England.  
Birth of Jane Cobb<sup>136</sup> in Coventry, Warwickshire, England.  
Birth of Robert Marsden<sup>155</sup> in Halliwell, Lancashire, England.  
Death of William Brayshaw<sup>238</sup> on 4 July, in Burton in Lonsdale, Yorkshire, England.  
Death of Mary Ann Brayshaw<sup>204</sup> on 4 July, in Burton in Lonsdale, Yorkshire, England.  
Marriage of James Atkinson<sup>173</sup> and Jane Hodson<sup>174</sup> on 19 November, in Bolton-le-Moors, Lancashire, England.  
Birth of Jane Anne Stimson<sup>160</sup> in about 1856, in Wansford, Northamptonshire, England.  
Death of Richard Roorcroft<sup>201</sup> in about 1856.
- 1857**  
Birth of Thomas Templeman<sup>135</sup> in Essendine, Rutland, England.  
Birth of Mary Atkinson<sup>148</sup> in Bolton, Lancashire, England.
- 1858**  
Birth of John Marsden<sup>157</sup> in Great Harwood, Lancashire, England.  
Death of Christopher Atkinson<sup>207</sup> in Bolton, Lancashire, England.  
Death of Frances (Fanny) Hadkin<sup>187</sup> in December, in Haigh, Wigan, Lancashire, England.
- 1859**  
Birth of Henry Atkinson<sup>149</sup> in Bolton, Lancashire, England.  
Birth of Fanny Elizabeth Jameson<sup>143</sup> in December, in Haigh, Lancashire, England.
- 1861**  
Birth of Mary Ellen Marsden<sup>140</sup> in April, in Halliwell, Bolton, Lancashire, England.  
Birth of Isabella Atkinson<sup>150</sup> in Bolton, Lancashire, England.  
Residence of William Thomas Marsden<sup>153</sup> in St Lawrence, Great Harwood, Lancashire, England.  
Residence of John Marsden<sup>157</sup> in St Lawrence, Great Harwood, Lancashire, England.  
Residence of Jane Cobb<sup>136</sup> in Coventry, St Thomas, Coventry St Michael, Warwickshire, England.  
Residence of James Marsden<sup>154</sup> in St Lawrence, Great Harwood, Lancashire, England.  
Residence of Elizabeth (Betty) Bolton<sup>177</sup> in St Lawrence, Great Harwood, Lancashire, England.  
Residence of Robert Marsden<sup>155</sup> in St Lawrence, Great Harwood, Lancashire, England.

- 1862**  
 Burial of William Thomas Marsden<sup>153</sup> on 2 June, in Great Harwood, Lancashire, England.  
 Birth of John Atkinson<sup>139</sup> on 8 June, in Bolton, Lancashire, England.  
 Birth of Amy Ann Woodward<sup>159</sup> in Westhoughton Bolton Lancashire 8c / 219.  
 Death of William Thomas Marsden<sup>153</sup> in about 1862.
- 1863**  
 Marriage of John Stimson<sup>182</sup> and Sarah Posnette<sup>183</sup> on 24 May, in Saint John, Coventry, Warwick, England.  
 Death of Peggy (Margaret) Huntington<sup>243</sup> in Garstang, Lancashire, England.
- 1865**  
 Birth of Robert Roocroft<sup>137</sup> on 1 January, in Bolton, Lancashire, England.  
 Baptism of Richard (Dick) Marsden<sup>158</sup> on 12 February, in Bolton-le-Moors, Lancashire, England.  
 Birth of Elizabeth Atkinson<sup>151</sup> in Bolton, Lancashire, England.  
 Birth of Richard (Dick) Marsden<sup>158</sup> in Bolton, Lancashire, England.
- 1866**  
 Death of Catherine Charlotte Atkinson<sup>202</sup> on 31 December, in Preston, Lancashire, England, United Kingdom.
- 1867**  
 Death of Catherine Lattimore<sup>200</sup> in April, in Stamford, Huntingdonshire, Northamptonshire, United Kingdom.  
 Death of William Stimson<sup>199</sup> in June, in Norfolk, England.  
 Birth of Edith Atkinson<sup>152</sup> in Bolton, Lancashire, England.
- 1868**  
 Death of Mary Wright<sup>208</sup> in Bolton, Lancashire, England.
- 1869**  
 Birth of Elizabeth Evelyne Best<sup>138</sup> in July, in Bolton, Lancashire, England.
- 1870**  
 Death of Rebecca Payne<sup>198</sup> on 26 February, in Wellingborough, Northamptonshire, England.  
 Birth of William Roocroft<sup>146</sup> on 11 April, in Bolton, Lancashire, England.
- 1871**  
 Burial of Ellen Jameson<sup>141</sup> on 19 July, in Haigh, Lancashire, England.  
 Death of Ellen Jameson<sup>141</sup> in about 1871.
- 1872**  
 Death of John Cobb<sup>197</sup> in October, in Wellingborough, Northamptonshire, United Kingdom.
- 1873**  
 Birth of Clara Talbot<sup>147</sup> on 18 February, in Bolton, Lancashire, England.  
 Death of Mary Bibby<sup>211</sup> in April, in Rochdale, Lancashire.
- 1875**  
 Death of Peter Jameson<sup>186</sup> on 16 January, in Wigan, Lancashire.  
 Burial of Peter Jameson<sup>186</sup> on 16 January, in Haigh, Lancashire, England.  
 Death of James Ashburn<sup>205</sup> in March, in Lancashire, United Kingdom.
- 1876**  
 Marriage of Robert Marsden<sup>155</sup> and Martha Wilkinson<sup>156</sup> in October, in Bolton Lancashire.
- 1877**  
 Birth of Thomas Marsden<sup>126</sup> on 18 September, in Little Hulton, Bolton, Lancashire, England.
- 1878**  
 Marriage of Thomas Templeman<sup>135</sup> in July, in Bourne, Lincolnshire, United Kingdom.  
 Marriage of John Jameson<sup>133</sup> and Mary Elizabeth Corris<sup>134</sup> on 31 July, in St Pauls, Tranmere, Cheshire, England.  
 Death of James Altham Batty<sup>203</sup> in October, in Wakefield, Yorkshire West Riding.  
 Death of Jane Harrison<sup>164</sup> on 7 November, in Rock Ferry, Cheshire, England, United Kingdom.  
 Birth of William Corris Jameson<sup>103</sup> in December, in Rock Ferry, Cheshire, England.
- 1879**  
 Death of Elizabeth (Betty) Bolton<sup>177</sup> in June.  
 Birth of Amos Stimson Templeman<sup>108</sup> in Carlby, Lincoln.  
 Birth of Katherine Sargeant<sup>109</sup> in Pickworth Rutland.
- 1880**  
 Birth of Edward Corris Jameson<sup>99</sup> on 30 April, in Wigan, Lancashire, England.
- 1881**  
 Burial of James Marsden<sup>154</sup> on 22 February, in Great Harwood, Lancashire, England.  
 Birth of Louisa (Kate) Catherine Templeman<sup>110</sup> on 17 March, in Carlby, Lincolnshire, England.  
 Birth of Lucy Pendlebury<sup>127</sup> on 6 April.  
 Baptism of Lucy Pendlebury<sup>127</sup> on 22 May, in Farnworth with Kearsley, St John The Evangelist, Lancashire, England.  
 Residence of Edward Roocroft<sup>169</sup> in Halliwell, Lancashire, England.  
 Death of James Marsden<sup>154</sup> in about 1881.
- 1882**  
 Birth of Jane Corris Jameson<sup>104</sup> in June, in Wigan, Lancashire, England.

**1883**

Death of Ann Allen<sup>166</sup> in February.  
 Birth of George O A Sellen<sup>106</sup> on 27 May.  
 Death of Mary Reedman<sup>194</sup> in June, in Lincolnshire, United Kingdom.

**1884**

Birth of Albert George Wakefield<sup>111</sup> on 12 March, in Stamford, Lincolnshire, United Kingdom.  
 Birth of Amelia Ann Jameson<sup>105</sup> on 24 November, in Patricroft, Lancashire, England.

**1885**

Marriage of John Atkinson<sup>139</sup> and Mary Ellen Marsden<sup>140</sup> in October, in Bolton, Lancashire, England.

**1886**

Death of Jane Corris Jameson<sup>104</sup> in September, in Lancashire, United Kingdom.

**1888**

Birth of Emma Templeman<sup>100</sup> on 26 May, in Carlby, Lincoln.  
 Death of Amos Cobb<sup>167</sup> in Warwick, Warwickshire.

**1889**

Death of Edward Roocroft<sup>169</sup> on 23 January, in Bolton, Lancashire, England.  
 Probate: Edward Roocroft<sup>169</sup> on 7 March, in Manchester, England.

**1890**

Death of James Atkinson<sup>173</sup> in April, in Bolton, Lancashire, England.

**1891**

Marriage of Matthew Lofthouse<sup>175</sup> and Jane Hodson<sup>174</sup> on 27 June, in Bolton, Lancashire, England.  
 Residence of Emma Templeman<sup>100</sup> in Carlby, Carlby, Carlby, Lincolnshire, England.  
 Residence of Thomas Marsden<sup>176</sup> in Ramsbottom, St Andrew, Tottington Lower End, Lancashire, England.  
 Residence of Louisa (Kate) Catherine Templeman<sup>110</sup> in Carlby, Carlby, Carlby, Lincolnshire, England.  
 Residence of Richard (Dick) Marsden<sup>158</sup> in Edge Fold, St George the Martyr, Middle Hulton, Lancashire, England.  
 Residence of Elizabeth (Betty) Bolton<sup>177</sup> in Edge Fold, St George the Martyr, Middle Hulton, Lancashire, England.  
 Birth of John Jameson<sup>107</sup> in about 1891, in Horwich, Lancashire, England.

**1892**

Birth of Charles Watkin Jones<sup>115</sup> in Horwich, Lancashire, England.

**1893**

Marriage of Robert Roocroft<sup>137</sup> and Elizabeth Evelyne Best<sup>138</sup> in April, in Bolton, Lancashire, England.  
 Birth of William Roocroft<sup>113</sup> in April, in Bolton, Lancashire, England.  
 Death of Edward Corris<sup>163</sup> in December, in Birkenhead, Cheshire, England.

**1894**

Birth of Alice Roocroft<sup>114</sup> on 21 January, in Bolton, Lancashire, England.

**1895**

Birth of Ethel Roocroft<sup>116</sup> on 17 April, in Bolton, Lancashire, England.

**1896**

Death of Henry Atkinson<sup>149</sup> on 31 December, in Bolton, Lancashire, England.

**1897**

Marriage of William Roocroft<sup>146</sup> in April, in Bolton, Lancashire, England.  
 Marriage of William Roocroft<sup>146</sup> and Clara Talbot<sup>147</sup> on 30 June, in Halliwell Rd Chapel, Bolton, Lancaster, England.  
 Birth of Edith Marsden<sup>128</sup> in Daubhill, Bolton, Lancashire, England.  
 Birth of Ernest Croft Wood<sup>121</sup> on 23 August, in Bolton, Lancashire, England.  
 Birth of James Roocroft<sup>101</sup> on 8 October, in Bolton, Lancashire, England.

**1898**

Birth of Linda Marsden Atkinson<sup>120</sup> in January, in Bolton, Lancashire, England.  
 Birth of Thomas Harold Roocroft<sup>118</sup> on 24 June, in Bolton, Lancashire, England.  
 Death of Elizabeth Arrowsmith<sup>162</sup> in August, in Wigan, Lancashire, United Kingdom.

**1899**

Birth of Mary (Polly) Elizabeth Marsden<sup>129</sup> in Bolton, Lancashire, England.  
 Birth of Dora Marsden Atkinson<sup>102</sup> on 16 December, in Bolton, Lancashire, England.  
 Birth of Edith Templeman<sup>112</sup> in about 1899, in Carlby, Lincolnshire, England.

**1900**

Death of Sarah Posnette<sup>183</sup> in March, in Long Ashton, Somerset, England.

- 1901**  
 Death of Jane Stimson<sup>168</sup> in January, in Coventry, Warwickshire, West Midlands, United Kingdom.  
 Marriage of Amos Stimson Templeman<sup>108</sup> in April, in Stamford, Lincolnshire, United Kingdom.  
 Residence of Robert Marsden<sup>155</sup> in Bolton, Daubhill, and Rumworth, Bolton, Lancashire, England.  
 Residence of Martha Wilkinson<sup>156</sup> in Bolton, Daubhill, and Rumworth, Bolton, Lancashire, England.  
 Residence of Thomas Templeman<sup>135</sup> in Carlby, Carlby, Lincolnshire, England.  
 Residence of Thomas Marsden<sup>126</sup> in Bolton, Daubhill, and Rumworth, Bolton, Lancashire, England.  
 Residence of Emma Templeman<sup>100</sup> in Carlby, Carlby, Lincolnshire, England.  
 Residence of Jane Cobb<sup>136</sup> in Carlby, Carlby, Lincolnshire, England.  
 Residence of Edith Templeman<sup>112</sup> in Carlby, Carlby, Lincolnshire, England.  
 Birth of Edward Walsh Roorcroft<sup>119</sup> on 5 September, in Bolton, Lancashire, England.  
 Death of Mary Batty<sup>170</sup> on 7 September, in Bolton, Lancashire, England.
- 1902**  
 Death of John Stimson<sup>182</sup> in April, in Long Ashton, Somerset, England.  
 Death of Jane Cobb<sup>136</sup> in June, in Lincolnshire, United Kingdom.  
 Marriage of Amos Stimson Templeman<sup>108</sup> and Katherine Sargeant<sup>109</sup>.  
 Birth of Elsie Marsden<sup>131</sup>.  
 Marriage of Thomas Marsden<sup>126</sup> and Lucy Pendlebury<sup>127</sup> in July, in Bolton, Lancashire, United Kingdom.  
 Birth of John Thomas Lomax<sup>130</sup> in about 1902.
- 1904**  
 Death of William Templeman<sup>165</sup> in January.  
 Death of Robert Marsden<sup>155</sup> in December, in Lancashire, United Kingdom.
- 1906**  
 Birth of Aileen Mary King<sup>123</sup> on 10 January, in Nottingham, Nottinghamshire, England.  
 Death of Thomas Marsden<sup>176</sup> in January, in Doncaster, Yorkshire West Riding.  
 Death of Mary Elizabeth Corris<sup>134</sup> in September, in Bolton, Lancashire, England.
- 1907**  
 Death of Thomas Walsh Best<sup>171</sup> on 23 January, in Lancashire, England.
- 1908**  
 Birth of Eric Talbot Roorcroft<sup>122</sup> on 18 August, in Bolton, Lancashire, England.
- 1911**  
 Residence of Louisa (Kate) Catherine Templeman<sup>110</sup> in Manthorpe and Carlby, Lincolnshire, England.  
 Residence of Amy Ann Woodward<sup>159</sup> in Bolton, Lancashire, England.  
 Residence of Thomas Templeman<sup>135</sup> in Manthorpe and Carlby, Lincolnshire, England.  
 Residence of Lucy Pendlebury<sup>127</sup> in Bolton, Lancashire, England.  
 Residence of William Roorcroft<sup>146</sup> in Bolton, Lancashire, England.  
 Death of Jane Hodson<sup>174</sup> in July, in Fylde, Lancashire.
- 1912**  
 Birth of Janik Jablonski<sup>85</sup> on 24 October, in Vilna Poland.
- 1913**  
 Marriage of Edward Corris Jameson<sup>99</sup> in April, in Bolton, Lancashire, England.  
 Marriage of Edward Corris Jameson<sup>99</sup> and Emma Templeman<sup>100</sup> on 25 June, in Bolton, Lancashire, England.  
 Marriage of Charles Watkin Jones<sup>115</sup> in October, in Bolton, Lancashire, England.
- 1914**  
 Birth of John Corris Jameson<sup>81</sup> on 19 March, in Bolton, Lancashire, England.  
 Death of Matthew Lofthouse<sup>175</sup> on 19 June, in Blackpool, Lancashire, England.  
 Birth of Sarah Gardiner<sup>82</sup> on 14 September, in Craghead, Co.Durham.
- 1915**  
 Residence of Robert Roorcroft<sup>137</sup> in Bolton, Lancashire, England.  
 Residence of James Roorcroft<sup>101</sup> in 139 Mere Hall St, Bolton.  
 Death of Mary Ellen Marsden<sup>140</sup> on 3 November, in Bolton, Lancashire, England.
- 1916**  
 Death of William Jameson<sup>161</sup> in May.  
 Marriage of Albert George Wakefield<sup>111</sup> and Louisa (Kate) Catherine Templeman<sup>110</sup> in October, in Bourne, Lincolnshire, United Kingdom.  
 Birth of Cissie Marsden<sup>124</sup> on 17 November.
- 1917**  
 Birth of Muriel Irene Jones<sup>92</sup> on 5 September, in Bolton, Lancashire, England.  
 Baptism of Muriel Irene Jones<sup>92</sup> on 9 December, in Bolton, Lancashire, England.
- 1919**  
 Death of Peter Jameson<sup>179</sup> on 5 October, in Wigan, Lancashire, England.
- 1920**  
 Birth of Edward Dennis Jameson<sup>83</sup> on 1 March, in Bolton, Lancashire, England.

**1921**

Birth of Audrey Templeman<sup>91</sup> in April, in Bourne, Lincolnshire.  
 Residence of Edith Marsden<sup>128</sup> in Kearsley, Lancashire, England.  
 Residence of Mary (Polly) Elizabeth Marsden<sup>129</sup> in Kearsley, Lancashire, England.  
 Residence of Elsie Marsden<sup>131</sup> in Kearsley, Lancashire, England.  
 Residence of Muriel Irene Jones<sup>92</sup> in Bolton, Lancashire, England.  
 Residence of Edward Corris Jameson<sup>99</sup> in Bolton, Lancashire, England.  
 Residence of John Corris Jameson<sup>81</sup> in Bolton, Lancashire, England.  
 Residence of Edward Dennis Jameson<sup>83</sup> in Bolton, Lancashire, England.  
 Residence of Alice Roocroft<sup>114</sup> in Bolton, Lancashire, England.  
 Residence of Emma Templeman<sup>100</sup> in Bolton, Lancashire, England.  
 Residence of Richard (Dick) Marsden<sup>158</sup> in Kearsley, Lancashire, England.  
 Residence of Charles Watkin Jones<sup>115</sup> in Bolton, Lancashire, England.  
 Residence of Amy Ann Woodward<sup>159</sup> in Kearsley, Lancashire, England.  
 Birth of Brenda Jameson<sup>84</sup> on 8 October, in Bolton, Lancashire, England.

**1922**

Death of Mary Ann Ashburn<sup>172</sup> in December, in Salford, Lancashire, England.

**1923**

Marriage of Herbert Campbell<sup>117</sup> and Ethel Roocroft<sup>116</sup> in April, in Bolton, Lancashire, England.  
 Death of Elizabeth Atkinson<sup>151</sup> in Bolton, Lancashire, England.  
 Birth of Kathleen Nina Jameson<sup>86</sup> on 14 July, in Bolton, Lancashire, England.  
 Marriage of Ernest Croft Wood<sup>121</sup> and Linda Marsden Atkinson<sup>120</sup> in July, in Bolton, Lancashire, England.  
 Death of Elizabeth Evelyne Best<sup>138</sup> in September, in Warrington, Lancashire, England.  
 Death of Lucy Pendlebury<sup>127</sup> in October, in Bolton, Lancashire, England.

**1924**

Death of Jane Anne Stimson<sup>160</sup> in January, in Kings Norton, Warwickshire, England.  
 Birth of Margaret Linda Wood<sup>93</sup> on 13 June, in Bolton, Lancashire, England.  
 Death of John Marsden<sup>157</sup>.  
 Birth of Leslie James Harwood<sup>94</sup> on 31 August, in St Helens, Lancashire, England.  
 Birth of Donald Templeman Jameson<sup>87</sup> on 29 December, in Bolton, Lancashire, England.

**1925**

Death of Edith Templeman<sup>112</sup> in January, in Bourne, Lincolnshire, England.  
 Death of Mary Atkinson<sup>148</sup> in Fylde, Lancashire, England.

**1926**

Birth of John Derek Wood<sup>95</sup> on 13 July, in Bolton, Lancashire, England.  
 Birth of Robert Bryan Jameson<sup>79</sup> in December, in Bolton, Lancashire, England.

**1927**

Birth of Barbara E Bibby<sup>96</sup>.  
 Marriage of James Roocroft<sup>101</sup> and Dora Marsden Atkinson<sup>102</sup> on 5 October, in Bolton, Lancashire, England.

**1928**

Death of Martha Wilkinson<sup>156</sup> in April, in Bolton Lancashire 8c / 352.  
 Birth of Mary Atkinson Roocroft<sup>80</sup> on 8 September.

**1930**

Marriage of John Thomas Lomax<sup>130</sup> and Mary (Polly) Elizabeth Marsden<sup>129</sup> on 4 March, in Bolton, Lancashire, England.  
 Birth of Sheila Sanderson<sup>88</sup> on 16 July, in Nelson, Lancashire, England.

**1931**

Birth of John Marsden Roocroft<sup>89</sup> in July, in Bolton, Lancashire, England.

**1935**

Marriage of Eric Talbot Roocroft<sup>122</sup> and Aileen Mary King<sup>123</sup> in April, in Bolton, Lancashire, England.

**1936**

Death of Robert Roocroft<sup>137</sup> in April, in Bolton, Lancashire, England.  
 Death of William Roocroft<sup>113</sup> on 25 April, in Glossop, Derbyshire, England.  
 Death of Amy Ann Woodward<sup>159</sup> in July, in Bolton, Lancashire, England.  
 Birth of David Ewart Roocroft<sup>97</sup> on 19 July, in Bolton, Lancashire, England.

**1937**

Birth of Irene Elizabeth McDonald Brock<sup>98</sup> in Bolton, Lancashire, England.  
 Birth of Joan Haddock<sup>90</sup> in July, in Bolton, Lancashire, England.

**1938**

Death of Thomas Templeman<sup>135</sup> in October, in Bourne, Lincolnshire, England.

- 1939**  
 Death of William Corris Jameson<sup>103</sup> on 4 January, in 21 Astbury Avenue Audenshaw Lancashire.  
 Birth of Paul Thomas O'Mara<sup>55</sup>.  
 Residence of Amelia Ann Jameson<sup>105</sup> in Lancashire, England.  
 Residence of George O A Sellen<sup>106</sup> in Lancashire, England.  
 Residence of Donald Templeman Jameson<sup>87</sup> in Lancashire, England.  
 Residence of John Corris Jameson<sup>81</sup> in Lancashire, England.  
 Residence of Kathleen Nina Jameson<sup>86</sup> in Lancashire, England.  
 Residence of Edward Dennis Jameson<sup>83</sup> in Lancashire, England.  
 Death of Edith Atkinson<sup>152</sup> in Blackpool, Lancashire, England.  
 Marriage of John Corris Jameson<sup>81</sup> and Sarah Gardiner<sup>82</sup> on 31 December, in Craghead, Durham, England.
- 1940**  
 Residence of Eric Talbot Roocroft<sup>122</sup> in Lancashire, England, United Kingdom.  
 Birth of Margaret Jameson<sup>48</sup> on 14 October, in Farnworth, Lancashire.
- 1941**  
 Birth of Roy Wardle<sup>49</sup> on 11 February, in Bolton, Lancashire, England.
- 1942**  
 Death of Mary Jameson<sup>142</sup>.
- 1943**  
 Death of William Roocroft<sup>146</sup> on 5 July, in Bolton, Lancashire, England.
- 1944**  
 Death of Edward Dennis Jameson<sup>83</sup> on 27 July, in Bolton, Lancashire, England.  
 Death of Richard (Dick) Marsden<sup>158</sup> in October.  
 Marriage of Janik Jablonski<sup>85</sup> and Brenda Jameson<sup>84</sup> on 24 October, in Westminster, Middlesex, United Kingdom.  
 Probate: Edward Dennis Jameson<sup>83</sup> on 16 November, in Llandudno.
- 1945**  
 Death of Isabella Atkinson<sup>150</sup> in Bolton.
- 1947**  
 Birth of Susan D Jameson<sup>50</sup> in January, in Farnworth, Lancashire.
- 1948**  
 Birth of Catherine R Warmington<sup>53</sup> in April, in Wells, Somerset.  
 Birth of Edwina M Jablonski<sup>54</sup> in July, in Bolton, Lancashire, England.  
 Marriage of Albert Lord<sup>132</sup> and Elsie Marsden<sup>131</sup> in October, in Bolton, Lancashire, England.
- 1949**  
 Birth of Janina M A Jablonski<sup>56</sup> in October, in Uxbridge, Middlesex.
- 1950**  
 Death of Albert George Wakefield<sup>111</sup> in June, in Stamford, Lincolnshire, England.
- 1951**  
 Marriage of Robert Bryan Jameson<sup>79</sup> and Mary Atkinson Roocroft<sup>80</sup> in January, in Bolton, Lancashire, England.  
 Death of Linda Marsden Atkinson<sup>120</sup> on 4 April, in Prescott, Lancashire.  
 Death of Edward Corris Jameson<sup>99</sup> on 13 April, in Bolton, Lancashire, England.
- 1952**  
 Birth of Andrew John Jameson<sup>40</sup> on 5 April, in Havercroft, Bolton, Lancashire, England.  
 Death of Fanny Elizabeth Jameson<sup>143</sup>.  
 Birth of Dennis C Jablonski<sup>58</sup> in July, in Uxbridge, Middlesex.
- 1953**  
 Marriage of John Derek Wood<sup>95</sup> and Barbara E Bibby<sup>96</sup> in January, in Bolton, Lancashire, England.  
 Death of John Atkinson<sup>139</sup>.  
 Death of Amelia Ann Jameson<sup>105</sup> on 14 July.  
 Burial of Amelia Ann Jameson<sup>105</sup> on 17 July, in Lancashire, England.  
 Birth of Sally Emerson<sup>43</sup> on 21 July, in Newcastle upon Tyne, Northumberland.  
 Marriage of Donald Templeman Jameson<sup>87</sup> and Sheila Sanderson<sup>88</sup> on 12 August, in Bolton, Lancashire, England.
- 1954**  
 Birth of Judith Anne Whitehurst<sup>41</sup> in May, in Stoke, Staffordshire.  
 Birth of Linda Jane Jameson<sup>44</sup> on 20 September, in Bolton, Lancashire, England.  
 Birth of Sheila Anne Jameson<sup>62</sup> in October, in Farnworth, Lancashire.  
 Birth of Andrew P Jablonski<sup>60</sup> in October, in Lewisham, Greater London.
- 1955**  
 Birth of Stephen Bailey<sup>74</sup> on 11 August.  
 Death of Thomas Harold Roocroft<sup>118</sup> on 13 August, in Vancouver, British Columbia, Canada.
- 1956**  
 Birth of Richard D Jameson<sup>64</sup> in January, in Bolton, Lancashire, England.  
 Marriage of Leslie James Harwood<sup>94</sup> and Margaret Linda Wood<sup>93</sup> in July, in Bolton, Lancashire, England.

**1957**

- Birth of Peter M Jameson<sup>65</sup> in April, in Bolton, Lancashire, England.  
 Birth of Jane Elizabeth Woods<sup>42</sup> on 25 May, in Preston, Lancashire, England.  
 Birth of Kathryn Mary Jameson<sup>46</sup> on 8 August, in Bolton, Lancashire, England.  
 Death of Clara Talbot<sup>147</sup> on 13 November, in Bolton, Lancashire, England.

**1958**

- Birth of Beverley J Thornley<sup>78</sup> in April, in Bolton, Lancashire, England.  
 Marriage of John Marsden Roorcroft<sup>89</sup> and Joan Haddock<sup>90</sup> in July, in Bolton, Lancashire, England.  
 Death of John Jameson<sup>107</sup> in July, in Fylde, Lancashire, England.  
 Birth of David J Roorcroft<sup>71</sup> on 26 August, in Farnworth, Lancashire.

**1959**

- Death of Alice Roorcroft<sup>114</sup> on 12 January, in Bolton, Lancashire, England.  
 Birth of Jean S Jameson<sup>66</sup> in October, in Bolton, Lancashire, England.  
 Birth of Ian J Brown<sup>76</sup> on 11 November.

**1960**

- Marriage of David Ewart Roorcroft<sup>97</sup> and Irene Elizabeth McDonald Brock<sup>98</sup> on 8 June, in Bolton, Lancashire, England.  
 Death of Edward Walsh Roorcroft<sup>119</sup> on 19 September, in Islington Brookfield, London, England.

**1961**

- Birth of Simon A Roorcroft<sup>77</sup> in October, in Bolton, Lancashire, England.

**1962**

- Birth of Carolyn Anne Harwood<sup>73</sup> in April, in Prescott, Lancashire.  
 Death of Thomas Marsden<sup>126</sup>.

**1963**

- Birth of Caroline Roorcroft<sup>72</sup> on 2 April.

**1964**

- Birth of Judith Harwood<sup>75</sup> in January, in Prescott, Lancashire.  
 Birth of Elizabeth H Jameson<sup>67</sup> in January, in Farnworth, Lancashire.

**1966**

- Marriage of Roy Wardle<sup>49</sup> and Margaret Jameson<sup>48</sup> on 20 July, in Bolton, Lancashire, England.  
 Death of Emma Templeman<sup>100</sup> on 25 December, in Bolton, Lancashire, England.

**1968**

- Death of Amos Stimson Templeman<sup>108</sup>.  
 Birth of Angela Ruth Jameson<sup>68</sup> in October, in Farnworth, Lancashire.

**1969**

- Birth of Robin Marcus Wardle<sup>21</sup> in January, in Bolton, Lancashire, England.  
 Marriage of Paul Thomas O'Mara<sup>55</sup> and Edwina M Jablonski<sup>54</sup> in July, in Chatham, Kent, United Kingdom.

**1970**

- Birth of Ian Robert Jameson<sup>70</sup> in July, in Blackpool, Lancashire.  
 Birth of Jason Andrew O'Mara<sup>28</sup> in October, in Wandsworth, London.

**1971**

- Birth of Edward Jonathan Wardle<sup>23</sup> in January, in Bolton, Lancashire, England.

**1972**

- Death of Louisa (Kate) Catherine Templeman<sup>110</sup> in April, in Stafford, Staffordshire, England.  
 Death of Albert Lord<sup>132</sup> on 10 May, in Bolton, Lancashire.

**1973**

- Marriage of John E Jablonski<sup>52</sup> and Catherine R Warmington<sup>53</sup> in January, in Andover, Hampshire, United Kingdom.  
 Marriage of Neil McLaren<sup>57</sup> and Janina M A Jablonski<sup>56</sup> in April, in Maidstone, Kent, United Kingdom.  
 Birth of Timothy James Wardle<sup>24</sup> in April, in Bolton, Lancashire, England.  
 Death of John Thomas Lomax<sup>130</sup> on 29 July.  
 Birth of Craig Antony O'Mara<sup>29</sup> in October, in Wandsworth, London.  
 Death of Ernest Croft Wood<sup>121</sup> in December, in Prescott, Lancashire, England.

**1975**

- Residence of Andrew John Jameson<sup>40</sup> in September, in Stornoway, Scotland.

**1976**

- Birth of Paula Elizabeth Anderson<sup>27</sup> in April, in Durham Northern, Durham.  
 Marriage of Andrew P Jablonski<sup>60</sup> and Anne J Crawley<sup>61</sup> in July, in High Peak, Derbyshire, United Kingdom.  
 Death of John Corris Jameson<sup>81</sup> on 4 November, in Withington Hospital, Manchester.  
 Burial of John Corris Jameson<sup>81</sup> on 10 November, in Lancashire, England.

**1977**

- Death of Elsie Marsden<sup>131</sup> on 6 January, in Bolton, Lancashire.  
 Residence of Andrew John Jameson<sup>40</sup> in January, in Black Isle, Scotland.  
 Death of Mary (Polly) Elizabeth Marsden<sup>129</sup> on 29 August, in Bolton, Lancashire.  
 Marriage of Andrew John Jameson<sup>40</sup> and Judith Anne Whitehurst<sup>41</sup> in December, in Bolton, Lancashire, England.

- 1978**  
 Birth of Scott McLaren<sup>30</sup> in April, in Surrey South Western, Surrey.  
 Death of Ethel Roocroft<sup>116</sup> on 2 July, in Bolton, Lancashire, England.  
 Birth of James Richard Somersall<sup>26</sup> in July, in N E Hants, Oxfordshire, Isle of Wight, Hampshire, Berkshire.  
 Birth of Pauline Anne Jablonski<sup>32</sup> in July, in Derby, Derbyshire.
- 1979**  
 Birth of Simon Andrew Jablonski<sup>33</sup> in October, in Derby, Derbyshire.
- 1980**  
 Birth of Amy McLaren<sup>31</sup> in January, in Surrey South Western, Surrey.  
 Death of Edith Marsden<sup>128</sup> on 13 February, in Bolton, Lancashire.  
 Marriage of Philip Booth<sup>63</sup> and Sheila Anne Jameson<sup>62</sup> in April, in Blackpool & Fylde, Lancashire, United Kingdom.
- 1981**  
 Birth of John Ross Jameson<sup>6</sup> on 16 May, in Raigmore, Inverness.  
 Death of Dora Marsden Atkinson<sup>102</sup> on 24 December, in Bolton, Lancashire, England.  
 Burial of Dora Marsden Atkinson<sup>102</sup> on 31 December, in Lancashire, England.
- 1982**  
 Birth of Timothy John Jablonski<sup>34</sup> in January, in Derby, Derbyshire.
- 1983**  
 Marriage of Dennis C Jablonski<sup>58</sup> and Laura E Slater<sup>59</sup> in July, in Chatham, Kent, United Kingdom.
- 1984**  
 Death of James Roocroft<sup>101</sup> on 22 February, in Bolton, Lancashire, England.  
 Burial of James Roocroft<sup>101</sup> on 28 February, in Lancashire, England.  
 Probate: James Roocroft<sup>101</sup> on 30 April, in Manchester, Lancashire, England.  
 Residence of David Ewart Roocroft<sup>97</sup> in Bolton, Lancashire, England.
- 1985**  
 Death of Janik Jablonski<sup>85</sup> on 19 April, in Chatham, Kent, England.  
 Birth of Robert Anthony Jablonski<sup>35</sup> in June, in Derby, Derbyshire.  
 Residence of Judith Anne Whitehurst<sup>41</sup> in Andover, Hampshire, England.  
 Residence of Andrew John Jameson<sup>40</sup> in September, in Appleshaw, Hampshire, England.  
 Birth of Linda Charlotte Vickers<sup>17</sup> on 20 November, in Bolton, Lancashire, England.
- 1986**  
 Birth of Roberto Camblor Jameson<sup>12</sup> on 26 March, in Madrid, Spain.
- 1987**  
 Birth of Thomas William Vickers<sup>19</sup> on 15 May, in Bolton, Lancashire, England.  
 Death of Eric Talbot Roocroft<sup>122</sup> on 28 May, in Bolton, Lancashire, England.  
 Marriage of Simon A Roocroft<sup>77</sup> and Beverley J Thornley<sup>78</sup> in Bolton, Lancashire, England.  
 Birth of Richard Manu<sup>11</sup>.  
 Birth of Robert Cameron Jameson<sup>7</sup> on 10 August, in Winchester, Hampshire.
- 1988**  
 Birth of Nicholas Camblor Jameson<sup>13</sup> on 10 February, in Santander, Cantabria, Spain.
- 1989**  
 Death of Aileen Mary King<sup>123</sup> on 7 February, in Lancashire, England.  
 Birth of Michael Lee Slack<sup>9</sup> on 3 March, in Sutton In Ashfield, Nottinghamshire, England.  
 Birth of Benjamin James Vickers<sup>20</sup> on 7 April, in Bolton, Lancashire, England.  
 Marriage of Ian J Brown<sup>76</sup> and Judith Harwood<sup>75</sup> in St. Helens, Merseyside, United Kingdom.  
 Divorce of Andrew John Jameson<sup>40</sup> and Judith Anne Whitehurst<sup>41</sup>.
- 1990**  
 Birth of Rachel Jane Watts<sup>8</sup> on 24 March, in Preston, Lancashire, England.
- 1991**  
 Residence of Andrew John Jameson<sup>40</sup> in January, in Dean Village, Edinburgh.  
 Birth of Mateo Camblor Jameson<sup>14</sup> on 13 March, in Santander, Cantabria, Spain.
- 1992**  
 Marriage of Robin Marcus Wardle<sup>21</sup> and Elizabeth J Stone<sup>22</sup> in Bromley, Greater London, United Kingdom.  
 Birth of Catherine Jane Emerson<sup>10</sup> on 19 November, in Hackney, London, England.
- 1993**  
 Birth of Martin Brown<sup>36</sup> on 21 January.  
 Birth of Sofia Camblor Jameson<sup>15</sup> on 13 September, in Santander, Cantabria, Spain.
- 1994**  
 Death of Cissie Marsden<sup>124</sup> on 25 April, in Stockport, Greater Manchester, England.  
 Marriage of Stephen Bailey<sup>74</sup> and Carolyn Anne Harwood<sup>73</sup> in Warrington, Cheshire, United Kingdom.
- 1995**  
 Residence of Andrew John Jameson<sup>40</sup> in June, in North Berwick, East Lothian, Scotland.  
 Separation: Andrew John Jameson<sup>40</sup> and Sally Emerson<sup>43</sup>.  
 Birth of Christopher Brown<sup>38</sup> on 19 September.  
 Birth of Linda Camblor Jameson<sup>16</sup> on 2 November, in Santander, Cantabria, Spain.

- 1996**  
Death of Sarah Gardiner<sup>82</sup> on 26 April, in Durham, Co.Durham.
- 1997**  
Birth of Nathan James Somersall<sup>4</sup> in June, in Durham Northern, Durham.
- 1999**  
Residence of Andrew John Jameson<sup>40</sup> in September, in Chorlton cum Hardy, Lancashire, England.
- 2000**  
Marriage of David A B Potts<sup>69</sup> and Angela Ruth Jameson<sup>68</sup> in Whitehaven, Cumbria, United Kingdom.
- 2001**  
Death of Kathleen Nina Jameson<sup>86</sup> on 10 January, in Bolton, Lancashire, England.
- 2002**  
Marriage of James Richard Somersall<sup>26</sup> and Paula Elizabeth Anderson<sup>27</sup> in Durham Northern, Durham, United Kingdom.
- 2003**  
Birth of Tristan Thomas Somersall<sup>5</sup> in August, in Durham Central, Durham.  
Residence of Andrew John Jameson<sup>40</sup> in August, in Astley village, Chorley, Lancashire, England.
- 2004**  
Marriage of Timothy James Wardle<sup>24</sup> and Jacqueline A Thornes<sup>25</sup> in Isle of Wight, Isle of Wight, United Kingdom.
- 2005**  
Death of Donald Templeman Jameson<sup>87</sup> on 23 September, in Thornton Cleveleys, Lancashire, England.
- 2006**  
Death of Leslie James Harwood<sup>94</sup> in Warrington, Cheshire, England.
- 2007**  
Residence of John Ross Jameson<sup>6</sup> in Andover, Hampshire, England, United Kingdom.
- 2009**  
Address: Jane Elizabeth Woods<sup>42</sup> in Pechon, Santander Province, Cantabria, Spain.  
Address: Andrew John Jameson<sup>40</sup> in Pechón, Spain.
- 2010**  
Death of John Marsden Rookcroft<sup>89</sup> on 16 December.  
Death of Paul Thomas O'Mara<sup>55</sup> on 30 December.
- 2011**  
Death of Margaret Linda Wood<sup>93</sup> in Warrington, Lancashire, England.
- 2012**  
Death of Robert Bryan Jameson<sup>79</sup> on 16 April, in Bolton, Lancashire, England.  
Death of Roy Wardle<sup>49</sup> on 8 December, in Bolton, Lancashire, England.
- 2013**  
Residence of John Ross Jameson<sup>6</sup> in Andover, Hampshire, England.
- 2014**  
Death of Brenda Jameson<sup>84</sup> on 21 March, in Canterbury, Kent, England.  
Residence of Sheila Sanderson<sup>88</sup> in York, North Yorkshire, England.  
Residence of Andrew John Jameson<sup>40</sup> in Pechón, Spain.  
Hoshika - Our Shiba Inu (D.O.B. : 12 September 2014Breeder : Jaquelin / Raquel Rodríguez, Amatsu Kami, Cartagena, Murcia, Spain): Jane Elizabeth Woods<sup>42</sup> on 12 September, in Pechón, Santander Province, Cantabria, Spain.
- 2015**  
Marriage of Michael Lee Slack<sup>9</sup> and Rachel Jane Watts<sup>8</sup> on 10 October, in London Zoo, Westminster, London, England.
- 2016**  
Death of Sheila Sanderson<sup>88</sup> on 20 July, in York, Yorkshire, England.
- 2017**  
Death of David J Rookcroft<sup>71</sup> on 25 August.
- 2018**  
Marriage of Richard Manu<sup>11</sup> and Catherine Jane Emerson<sup>10</sup> on 7 April, in Ghana.  
Marriage of Andrew John Jameson<sup>40</sup> and Jane Elizabeth Woods<sup>42</sup> on 19 May, in Contin, Ross-shire, Scotland.
- 2019**  
Death of Margaret Jameson<sup>48</sup> on 11 April, in Bolton, Lancashire, England.  
Death of Barbara E Bibby<sup>96</sup>.  
Death of Irene Elizabeth McDonald Brock<sup>98</sup> on 21 December.
- 2020**  
Death of John Derek Wood<sup>95</sup>.
- 2021**  
Residence of Andrew John Jameson<sup>40</sup> on 21 October, in Alyth, Perthshire, Scotland.
- 2024**  
Death of Jane Elizabeth Woods<sup>42</sup> on 27 September, in Alyth, Perthshire, Scotland.

**9. INDEX OF ANNIVERSARIES****JANUARY**

1. Birth of Robert Roocroft<sup>137</sup> in Bolton, Lancashire, England, in 1865
2. Marriage of George Harwood<sup>263</sup> and Alice Taylor<sup>264</sup> in Deane Parish Church, Bolton, Lancashire, in 1759
4. Death of James Jameson<sup>251</sup> in Wigan Lancashire England, in 1830  
Death of William Corris Jameson<sup>703</sup> in 21 Astbury Avenue Audenshaw Lancashire, in 1939
6. Burial of James Jameson<sup>251</sup> in Wigan, All Saints, Lancashire, England, in 1830  
Death of Elsie Marsden<sup>131</sup> in Bolton, Lancashire, in 1977
10. Birth of Aileen Mary King<sup>123</sup> in Nottingham, Nottinghamshire, England, in 1906  
Death of Kathleen Nina Jameson<sup>86</sup> in Bolton, Lancashire, England, in 2001
12. Death of Alice Roocroft<sup>114</sup> in Bolton, Lancashire, England, in 1959
16. Death of Peter Jameson<sup>186</sup> in Wigan, Lancashire, in 1875  
Burial of Peter Jameson<sup>186</sup> in Haigh, Lancashire, England, in 1875
21. Birth of Alice Roocroft<sup>114</sup> in Bolton, Lancashire, England, in 1894  
Birth of Martin Brown<sup>36</sup>, in 1993
23. Death of Edward Roocroft<sup>169</sup> in Bolton, Lancashire, England, in 1889  
Death of Thomas Walsh Best<sup>171</sup> in Lancashire, England, in 1907
24. Birth of Richard Roocroft<sup>201</sup> in Ulnes Walton, Lancashire, England, in 1785
27. Birth of Mary Woods<sup>252</sup> in Standishgate, Wigan, Lancashire, England, in 1758  
Death of John Harwood<sup>248</sup> in Heaton, Bolton, Lancashire, in 1770  
Death of George Harwood<sup>263</sup> in Blackburn, Lancashire, in 1794  
Birth of Edward Corris<sup>163</sup> in Patrick, Glenfaba, Isle of Man, Isle of Man, United Kingdom, in 1815  
Death of Elizabeth Moore<sup>237</sup> in Cherry Hinton, in 1818  
Birth of Sarah Posnette<sup>183</sup> in Market Deeping, Lincolnshire, England, in 1820  
Death of Elizabeth Berry<sup>227</sup> in Wellingborough, Northamptonshire, England, in 1830  
Death of Robert Reedman<sup>224</sup> in Langtoft Lincolnshire, in 1851  
Birth of Linda Marsden Atkinson<sup>120</sup> in Bolton, Lancashire, England, in 1898  
Death of Jane Stimson<sup>168</sup> in Coventry, Warwickshire, West Midlands, United Kingdom, in 1901  
Death of William Templeman<sup>165</sup>, in 1904  
Death of Thomas Marsden<sup>176</sup> in Doncaster, Yorkshire West Riding, in 1906  
Death of Jane Anne Stimson<sup>160</sup> in Kings Norton, Warwickshire, England, in 1924  
Death of Edith Templeman<sup>112</sup> in Bourne, Lincolnshire, England, in 1925  
Birth of Susan D Jameson<sup>50</sup> in Farnworth, Lancashire, in 1947  
Marriage of Robert Bryan Jameson<sup>79</sup> and Mary Atkinson Roocroft<sup>80</sup> in Bolton, Lancashire, England, in 1951  
Marriage of John Derek Wood<sup>95</sup> and Barbara E Bibby<sup>96</sup> in Bolton, Lancashire, England, in 1953  
Birth of Richard D Jameson<sup>64</sup> in Bolton, Lancashire, England, in 1956  
Birth of Elizabeth H Jameson<sup>67</sup> in Farnworth, Lancashire, in 1964  
Birth of Judith Harwood<sup>75</sup> in Prescott, Lancashire, in 1964  
Birth of Robin Marcus Wardle<sup>21</sup> in Bolton, Lancashire, England, in 1969  
Birth of Edward Jonathan Wardle<sup>23</sup> in Bolton, Lancashire, England, in 1971  
Marriage of John E Jablonski<sup>52</sup> and Catherine R Warmingtton<sup>53</sup> in Andover, Hampshire, United Kingdom, in 1973  
Residence of Andrew John Jameson<sup>40</sup> in Black Isle, Scotland, in 1977  
Birth of Amy McLaren<sup>31</sup> in Surrey South Western, Surrey, in 1980  
Birth of Timothy John Jablonski<sup>34</sup> in Derby, Derbyshire, in 1982  
Residence of Andrew John Jameson<sup>40</sup> in Dean Village, Edinburgh, in 1991

**FEBRUARY**

7. Death of Aileen Mary King<sup>123</sup> in Lancashire, England, in 1989
10. Birth of Nicholas Cambler Jameson<sup>13</sup> in Santander, Cantabria, Spain, in 1988
11. Birth of Roy Wardle<sup>49</sup> in Bolton, Lancashire, England, in 1941
12. Baptism of Richard (Dick) Marsden<sup>158</sup> in Bolton-le-Moors, Lancashire, England, in 1865
13. Death of Edith Marsden<sup>128</sup> in Bolton, Lancashire, in 1980
18. Birth of Clara Talbot<sup>147</sup> in Bolton, Lancashire, England, in 1873
19. Birth of William Wm Payne<sup>228</sup> in Northamptonshire, England, in 1759  
Marriage of William Jameson<sup>161</sup> and Elizabeth Arrowsmith<sup>162</sup> in St John the Divine, Pemberton, Lancashire, England, in 1844
20. Birth of William Atkinson<sup>240</sup> in Stalmine Lancashire England, in 1769
22. Burial of James Marsden<sup>154</sup> in Great Harwood, Lancashire, England, in 1881  
Death of James Roocroft<sup>101</sup> in Bolton, Lancashire, England, in 1984
26. Death of Ann (Nancy) Harwood<sup>245</sup> in Halliwell, Lancashire, in 1817

**FEBRUARY (Continued)**

- 26. Death of Rebecca Payne<sup>198</sup> in Wellingborough, Northamptonshire, England, in 1870
- 28. Burial of James Roocroft<sup>101</sup> in Lancashire, England, in 1984
- Birth of Mary Ann Brayshaw<sup>204</sup> in Burton, Yorkshire, England, in 1795
- Death of Sarah Johnson<sup>258</sup> in Leyland, Lancs, in 1809
- Death of Ann Allen<sup>166</sup>, in 1883

**MARCH**

- 1. Birth of Edward Dennis Jameson<sup>83</sup> in Bolton, Lancashire, England, in 1920
- 3. Birth of Michael Lee Slack<sup>9</sup> in Sutton In Ashfield, Nottinghamshire, England, in 1989
- 4. Marriage of John Thomas Lomax<sup>130</sup> and Mary (Polly) Elizabeth Marsden<sup>129</sup> in Bolton, Lancashire, England, in 1930
- 5. Birth of Margaret Cowley<sup>217</sup> in Ballaugh, Michael, Isle of Man, in 1720
- Marriage of Joshua Marsden<sup>261</sup> and Margaret Lyptrott<sup>262</sup> in Standish, Lancashire, England, in 1753
- 7. Death of William Corris<sup>216</sup> in Patrick, Glenfaba, Isle of Man, in 1774
- Probate: Edward Roocroft<sup>169</sup> in Manchester, England, in 1889
- 8. Death of William Atkinson<sup>240</sup> in Newcastle-Upon-Tyne, England, in 1847
- 12. Birth of Albert George Wakefield<sup>111</sup> in Stamford, Lincolnshire, United Kingdom, in 1884
- 13. Birth of Mateo Camblor Jameson<sup>14</sup> in Santander, Cantabria, Spain, in 1991
- 16. Birth of John Roocroft<sup>232</sup> in Croston, Lancashire, in 1757
- 17. Birth of Louisa (Kate) Catherine Templeman<sup>110</sup> in Carlby, Lincolnshire, England, in 1881
- 18. Death of Mary Woods<sup>252</sup> in Wigan Lancashire England, in 1807
- 19. Birth of John Corris Jameson<sup>81</sup> in Bolton, Lancashire, England, in 1914
- 20. Marriage of Christopher Atkinson<sup>207</sup> and Mary Wright<sup>208</sup> in Garstang, Lancashire, England, in 1820
- 21. Death of Robert Templeman<sup>193</sup> in Market Deeping, Lincolnshire, England, in 1850
- Death of Brenda Jameson<sup>84</sup> in Canterbury, Kent, England, in 2014
- 24. Birth of Rachel Jane Watts<sup>8</sup> in Preston, Lancashire, England, in 1990
- 25. Baptism of James Jameson<sup>251</sup> in Wigan, All Saints, Lancashire, England, in 1743
- Christening of James Jameson<sup>251</sup> in Wigan, Lancashire, England, in 1743
- 26. Birth of Roberto Camblor Jameson<sup>12</sup> in Madrid, Spain, in 1986
- Death of Catherine Callister<sup>254</sup> in Michael, Isle of Man (80), in 1758
- Death of James Ashburn<sup>205</sup> in Lancashire, United Kingdom, in 1875
- Death of Sarah Posnette<sup>183</sup> in Long Ashton, Somerset, England, in 1900

**APRIL**

- 1. Marriage of William Gaskell<sup>215</sup> and Margaret Jameson<sup>214</sup> in Wigan, All Saints, Lancashire, England, in 1799
- 2. Birth of Caroline Roocroft<sup>72</sup>, in 1963
- 4. Birth of Robert Reedman<sup>224</sup> in Tallington West Deeping Lincolnshire, in 1770
- Death of Linda Marsden Atkinson<sup>120</sup> in Prescot, Lancashire, in 1951
- 5. Birth of Andrew John Jameson<sup>40</sup> in Havercroft, Bolton, Lancashire, England, in 1952
- 6. Birth of Lucy Pendlebury<sup>127</sup>, in 1881
- 7. Birth of Benjamin James Vickers<sup>20</sup> in Bolton, Lancashire, England, in 1989
- Marriage of Richard Manu<sup>11</sup> and Catherine Jane Emerson<sup>10</sup> in Ghana, in 2018
- 11. Birth of William Roocroft<sup>146</sup> in Bolton, Lancashire, England, in 1870
- Death of Margaret Jameson<sup>48</sup> in Bolton, Lancashire, England, in 2019
- 13. Death of Edward Corris Jameson<sup>99</sup> in Bolton, Lancashire, England, in 1951
- 16. Death of Robert Bryan Jameson<sup>79</sup> in Bolton, Lancashire, England, in 2012
- 17. Birth of Ethel Roocroft<sup>116</sup> in Bolton, Lancashire, England, in 1895
- 19. Death of Janik Jablonski<sup>85</sup> in Chatham, Kent, England, in 1985
- 23. Marriage of Peter Marsden<sup>269</sup> and Anne Robinson<sup>270</sup> in Wigan, All Saints, Lancashire, England, in 1717
- 25. Death of William Roocroft<sup>113</sup> in Glossop, Derbyshire, England, in 1936
- Death of Cissie Marsden<sup>124</sup> in Stockport, Greater Manchester, England, in 1994
- 26. Death of Sarah Gardiner<sup>82</sup> in Durham, Co.Durham, in 1996
- 27. Birth of James Altham Batty<sup>203</sup> in Burton in Lonsdale, Yorkshire, England, in 1798
- 30. Birth of Edward Corris Jameson<sup>99</sup> in Wigan, Lancashire, England, in 1880
- Probate: James Roocroft<sup>101</sup> in Manchester, Lancashire, England, in 1984
- Death of Catherine Cubbon<sup>256</sup> in Michael, Isle of Man, in 1740
- Birth of Mary Ellen Marsden<sup>140</sup> in Halliwell, Bolton, Lancashire, England, in 1861
- Death of Catherine Lattimore<sup>200</sup> in Stamford, Huntingdonshire, Northamptonshire, United Kingdom, in 1867
- Death of Mary Bibby<sup>211</sup> in Rochdale, Lancashire, in 1873
- Death of James Atkinson<sup>173</sup> in Bolton, Lancashire, England, in 1890

**APRIL (Continued)**

- Marriage of Robert Roocroft<sup>137</sup> and Elizabeth Evelyne Best<sup>138</sup> in Bolton, Lancashire, England, in 1893  
 Birth of William Roocroft<sup>113</sup> in Bolton, Lancashire, England, in 1893  
 Marriage of William Roocroft<sup>146</sup> in Bolton, Lancashire, England, in 1897  
 Marriage of Amos Stimson Templeman<sup>108</sup> in Stamford, Lincolnshire, United Kingdom, in 1901  
 Death of John Stimson<sup>182</sup> in Long Ashton, Somerset, England, in 1902  
 Marriage of Edward Corris Jameson<sup>99</sup> in Bolton, Lancashire, England, in 1913  
 Birth of Audrey Templeman<sup>91</sup> in Bourne, Lincolnshire, in 1921  
 Marriage of Herbert Campbell<sup>117</sup> and Ethel Roocroft<sup>116</sup> in Bolton, Lancashire, England, in 1923  
 Death of Martha Wilkinson<sup>156</sup> in Bolton Lancashire 8c / 352, in 1928  
 Marriage of Eric Talbot Roocroft<sup>122</sup> and Aileen Mary King<sup>123</sup> in Bolton, Lancashire, England, in 1935  
 Death of Robert Roocroft<sup>137</sup> in Bolton, Lancashire, England, in 1936  
 Birth of Catherine R Warmington<sup>53</sup> in Wells, Somerset, in 1948  
 Birth of Peter M Jameson<sup>63</sup> in Bolton, Lancashire, England, in 1957  
 Birth of Beverley J Thornley<sup>78</sup> in Bolton, Lancashire, England, in 1958  
 Birth of Carolyn Anne Harwood<sup>73</sup> in Prescott, Lancashire, in 1962  
 Death of Louisa (Kate) Catherine Templeman<sup>110</sup> in Stafford, Staffordshire, England, in 1972  
 Marriage of Neil McLaren<sup>57</sup> and Janina M A Jablonski<sup>56</sup> in Maidstone, Kent, United Kingdom, in 1973  
 Birth of Timothy James Wardle<sup>24</sup> in Bolton, Lancashire, England, in 1973  
 Birth of Paula Elizabeth Anderson<sup>27</sup> in Durham Northern, Durham, in 1976  
 Birth of Scott McLaren<sup>30</sup> in Surrey South Western, Surrey, in 1978  
 Marriage of Philip Booth<sup>63</sup> and Sheila Anne Jameson<sup>62</sup> in Blackpool & Fylde, Lancashire, United Kingdom, in 1980

**MAY**

4. Baptism of Jane Cobb<sup>136</sup> in St Thomas', Coventry, Warwick, England, in 1856  
 10. Death of Albert Lord<sup>132</sup> in Bolton, Lancashire, in 1972  
 15. Birth of Thomas William Vickers<sup>19</sup> in Bolton, Lancashire, England, in 1987  
 16. Birth of John Ross Jameson<sup>6</sup> in Raigmore, Inverness, in 1981  
 19. Marriage of Andrew John Jameson<sup>40</sup> and Jane Elizabeth Woods<sup>42</sup> in Contin, Ross-shire, Scotland, in 2018  
 22. Death of Margaret Lyptrott<sup>262</sup> in Standish, Lancashire, in 1781  
 Baptism of Lucy Pendlebury<sup>127</sup> in Farnworth with Kearsley, St John The Evangelist, Lancashire, England, in 1881  
 24. Marriage of John Stimson<sup>182</sup> and Sarah Posnette<sup>183</sup> in Saint John, Coventry, Warwick, England, in 1863  
 25. Birth of Katharine Prickett<sup>235</sup> in Low Wood, Witherslack, Westmorland, in 1763  
 Birth of Jane Elizabeth Woods<sup>42</sup> in Preston, Lancashire, England, in 1957  
 26. Birth of Emma Templeman<sup>100</sup> in Carlby, Lincoln, in 1888  
 27. Birth of Thomas Batty<sup>236</sup> in Burton in Lonsdale, Yorkshire, in 1751  
 Birth of George O A Sellen<sup>106</sup>, in 1883  
 28. Death of Eric Talbot Roocroft<sup>122</sup> in Bolton, Lancashire, England, in 1987  
 Death of Anne Robinson<sup>270</sup> in Standish, Lancashire, England, in 1750  
 Death of Thomas Wright<sup>242</sup> in Garstang, Lancashire, England, in 1850  
 Death of William Jameson<sup>161</sup>, in 1916  
 Birth of Judith Anne Whitehurst<sup>41</sup> in Stoke, Staffordshire, in 1954

**JUNE**

1. Birth of Catherine Cubbon<sup>256</sup> in Jurby, Michael, Isle of Man, in 1687  
 2. Burial of William Thomas Marsden<sup>153</sup> in Great Harwood, Lancashire, England, in 1862  
 4. Marriage of Peter Jameson<sup>186</sup> and Frances (Fanny) Hadkin<sup>187</sup> in Saint Peter, Bolton Le Moors, Lancashire, England, in 1820  
 5. Birth of Peter Marsden<sup>244</sup> in Horwich, in 1758  
 8. Birth of John Atkinson<sup>139</sup> in Bolton, Lancashire, England, in 1862  
 Marriage of David Ewart Roocroft<sup>97</sup> and Irene Elizabeth McDonald Brock<sup>98</sup> in Bolton, Lancashire, England, in 1960  
 12. Birth of Elizabeth Moore<sup>237</sup> in Linton, Cambridgeshire, England, in 1757  
 13. Death of Elizabeth Cowin<sup>190</sup> in Isle of Man, United Kingdom, in 1852  
 Birth of Margaret Linda Wood<sup>93</sup> in Bolton, Lancashire, England, in 1924  
 19. Marriage(?) of James Ashburn<sup>205</sup> and Elizabeth McAlpine<sup>206</sup> in Manchester, St Mary, St Denys and St George, Lancashire, England, in 1850  
 Death of Matthew Lofthouse<sup>175</sup> in Blackpool, Lancashire, England, in 1914  
 24. Death of John Atkinson<sup>259</sup>, in 1802  
 Birth of Thomas Harold Roocroft<sup>118</sup> in Bolton, Lancashire, England, in 1898  
 25. Marriage of Edward Corris Jameson<sup>99</sup> and Emma Templeman<sup>100</sup> in Bolton, Lancashire, England, in 1913

**JUNE (Continued)**

27. Marriage of Matthew Lofthouse<sup>175</sup> and Jane Hodson<sup>174</sup> in Bolton, Lancashire, England, in 1891  
 30. Marriage of William Roocroft<sup>146</sup> and Clara Talbot<sup>147</sup> in Halliwell Rd Chapel, Bolton, Lancaster, England, in 1897  
 Birth of Sarah Johnson<sup>258</sup> in Ulnes Walton, Lancs, in 1731  
 Birth of William Roy Templeman<sup>222</sup> in Carlby, Lincolnshire, England, in 1769  
 Birth of Ann Allen<sup>166</sup> in Essendine, Rutland, in 1814  
 Death of Alice Downham<sup>239</sup> in Yorkshire West Riding, United Kingdom, in 1840  
 Death of Thomas Oxton<sup>220</sup> in Storeton, Cheshire, England, in 1842  
 Death of Elizabeth McAlpine<sup>206</sup> in Lancashire, United Kingdom, in 1852  
 Death of William Stimson<sup>199</sup> in Norfolk, England, in 1867  
 Death of Elizabeth (Betty) Bolton<sup>177</sup>, in 1879  
 Birth of Jane Corris Jameson<sup>104</sup> in Wigan, Lancashire, England, in 1882  
 Death of Mary Reedman<sup>194</sup> in Lincolnshire, United Kingdom, in 1883  
 Death of Jane Cobb<sup>136</sup> in Lincolnshire, United Kingdom, in 1902  
 Death of Albert George Wakefield<sup>111</sup> in Stamford, Lincolnshire, England, in 1950  
 Birth of Robert Anthony Jablonski<sup>35</sup> in Derby, Derbyshire, in 1985  
 Residence of Andrew John Jameson<sup>40</sup> in North Berwick, East Lothian, Scotland, in 1995  
 Birth of Nathan James Somersall<sup>4</sup> in Durham Northern, Durham, in 1997

**JULY**

2. Death of Ethel Roocroft<sup>116</sup> in Bolton, Lancashire, England, in 1978  
 4. Death of William Brayshaw<sup>238</sup> in Burton in Lonsdale, Yorkshire, England, in 1856  
 Death of Mary Ann Brayshaw<sup>204</sup> in Burton in Lonsdale, Yorkshire, England, in 1856  
 5. Death of William Roocroft<sup>146</sup> in Bolton, Lancashire, England, in 1943  
 11. Marriage of William Stimson<sup>199</sup> and Catherine Lattimore<sup>200</sup> in Yarwell, Northamptonshire, England, in 1814  
 13. Birth of John Derek Wood<sup>95</sup> in Bolton, Lancashire, England, in 1926  
 14. Birth of Kathleen Nina Jameson<sup>86</sup> in Bolton, Lancashire, England, in 1923  
 Death of Amelia Ann Jameson<sup>105</sup>, in 1953  
 15. Birth of Jane Hodson<sup>174</sup> in Bolton, Lancashire, England, in 1839  
 16. Birth of Sheila Sanderson<sup>88</sup> in Nelson, Lancashire, England, in 1930  
 17. Burial of Amelia Ann Jameson<sup>105</sup> in Lancashire, England, in 1953  
 18. Birth of Margaret Lyptrott<sup>262</sup> in Standish, Lancashire, in 1742  
 19. Burial of Ellen Jameson<sup>141</sup> in Haigh, Lancashire, England, in 1871  
 Birth of David Ewart Roocroft<sup>97</sup> in Bolton, Lancashire, England, in 1936  
 20. Marriage of Roy Wardle<sup>49</sup> and Margaret Jameson<sup>48</sup> in Bolton, Lancashire, England, in 1966  
 Death of Sheila Sanderson<sup>88</sup> in York, Yorkshire, England, in 2016  
 21. Birth of Sally Emerson<sup>43</sup> in Newcastle upon Tyne, Northumberland, in 1953  
 27. Baptism of John Stimson<sup>182</sup> in Northamptonshire, England, in 1823  
 Death of Edward Dennis Jameson<sup>83</sup> in Bolton, Lancashire, England, in 1944  
 29. Death of John Thomas Lomax<sup>130</sup>, in 1973  
 31. Marriage of John Jameson<sup>133</sup> and Mary Elizabeth Corris<sup>134</sup> in St Pauls, Tranmere, Cheshire, England, in 1878  
 Birth of Elizabeth Evelyne Best<sup>138</sup> in Bolton, Lancashire, England, in 1869  
 Marriage of Thomas Templeman<sup>135</sup> in Bourne, Lincolnshire, United Kingdom, in 1878  
 Marriage of Thomas Marsden<sup>126</sup> and Lucy Pendlebury<sup>127</sup> in Bolton, Lancashire, United Kingdom, in 1902  
 Death of Jane Hodson<sup>174</sup> in Fylde, Lancashire, in 1911  
 Marriage of Ernest Croft Wood<sup>121</sup> and Linda Marsden Atkinson<sup>120</sup> in Bolton, Lancashire, England, in 1923  
 Birth of John Marsden Roocroft<sup>89</sup> in Bolton, Lancashire, England, in 1931  
 Death of Amy Ann Woodward<sup>159</sup> in Bolton, Lancashire, England, in 1936  
 Birth of Joan Haddock<sup>90</sup> in Bolton, Lancashire, England, in 1937  
 Birth of Edwina M Jablonski<sup>54</sup> in Bolton, Lancashire, England, in 1948  
 Birth of Dennis C Jablonski<sup>58</sup> in Uxbridge, Middlesex, in 1952  
 Marriage of Leslie James Harwood<sup>94</sup> and Margaret Linda Wood<sup>93</sup> in Bolton, Lancashire, England, in 1956  
 Marriage of John Marsden Roocroft<sup>89</sup> and Joan Haddock<sup>90</sup> in Bolton, Lancashire, England, in 1958  
 Death of John Jameson<sup>107</sup> in Fylde, Lancashire, England, in 1958  
 Marriage of Paul Thomas O'Mara<sup>55</sup> and Edwina M Jablonski<sup>54</sup> in Chatham, Kent, United Kingdom, in 1969  
 Birth of Ian Robert Jameson<sup>70</sup> in Blackpool, Lancashire, in 1970  
 Marriage of Andrew P Jablonski<sup>60</sup> and Anne J Crawley<sup>61</sup> in High Peak, Derbyshire, United Kingdom, in 1976  
 Birth of Pauline Anne Jablonski<sup>32</sup> in Derby, Derbyshire, in 1978  
 Birth of James Richard Somersall<sup>26</sup> in N E Hants, Oxfordshire, Isle of Wight, Hampshire, Berkshire, in 1978  
 Marriage of Dennis C Jablonski<sup>58</sup> and Laura E Slater<sup>59</sup> in Chatham, Kent, United Kingdom, in 1983

**AUGUST**

8. Birth of Kathryn Mary Jameson<sup>46</sup> in Bolton, Lancashire, England, in 1957
10. Birth of Robert Cameron Jameson<sup>7</sup> in Winchester, Hampshire, in 1987
11. Birth of Stephen Bailey<sup>74</sup>, in 1955
12. Marriage of Peter Marsden<sup>244</sup> and Ann (Nancy) Harwood<sup>245</sup> in Prestbury, Cheshire, England, in 1769  
Marriage of Donald Templeman Jameson<sup>87</sup> and Sheila Sanderson<sup>88</sup> in Bolton, Lancashire, England, in 1953
13. Baptism of Thomas Walsh Best<sup>171</sup> in Bolton-le-Moors, St Peter, Lancashire, England, in 1837  
Death of Thomas Harold Roocroft<sup>118</sup> in Vancouver, British Columbia, Canada, in 1955
14. Marriage of William Corris<sup>216</sup> and Margaret Cowley<sup>217</sup> in Patrick, Isle of Man, England, in 1744
18. Birth of Eric Talbot Roocroft<sup>122</sup> in Bolton, Lancashire, England, in 1908
23. Birth of Ernest Croft Wood<sup>121</sup> in Bolton, Lancashire, England, in 1897
25. Death of David J Roocroft<sup>71</sup>, in 2017
26. Birth of Margaret Jameson<sup>214</sup> in Wigan, Lancashire, England, in 1779  
Birth of David J Roocroft<sup>71</sup> in Farnworth, Lancashire, in 1958
29. Death of Mary (Polly) Elizabeth Marsden<sup>129</sup> in Bolton, Lancashire, in 1977
31. Birth of Leslie James Harwood<sup>94</sup> in St Helens, Lancashire, England, in 1924  
Birth of Mary Wright<sup>208</sup> in Cabus, Lancashire, England, in 1799  
Death of Elizabeth Arrowsmith<sup>162</sup> in Wigan, Lancashire, United Kingdom, in 1898  
Residence of Andrew John Jameson<sup>40</sup> in Astley village, Chorley, Lancashire, England, in 2003  
Birth of Tristan Thomas Somersall<sup>5</sup> in Durham Central, Durham, in 2003

**SEPTEMBER**

3. Birth of Robert Marsden<sup>210</sup> in Dean, Lancashire, England, in 1790
5. Birth of Jane Middleton<sup>221</sup> in Upton by Birkenhead, Cheshire, England, in 1749  
Birth of Edward Walsh Roocroft<sup>119</sup> in Bolton, Lancashire, England, in 1901  
Birth of Muriel Irene Jones<sup>92</sup> in Bolton, Lancashire, England, in 1917
6. Marriage of Edward Corris<sup>163</sup> in Lancashire, United Kingdom, in 1838  
Marriage of Edward Corris<sup>163</sup> and Jane Harrison<sup>164</sup> in Liverpool, St Peter, Lancashire, England, in 1838
7. Death of Mary Batty<sup>170</sup> in Bolton, Lancashire, England, in 1901
8. Birth of Mary Atkinson Roocroft<sup>80</sup>, in 1928
11. Baptism of Margaret Jameson<sup>214</sup> in Wigan, Lancashire, England, in 1779
12. Hoshika - Our Shiba Inu (D.O.B. : 12 September 2014 Breeder : Jaquelin / Raquel Rodríguez, Amatsu Kami, Cartagena, Murcia, Spain): Jane Elizabeth Woods<sup>42</sup> in Pechón, Santander Province, Cantabria, Spain, in 2014
13. Marriage(?) of Peter Marsden<sup>244</sup> and Ann (Nancy) Harwood<sup>245</sup> in St Peter, Bolton-Le-Moors, Lancashire, England, in 1780  
Birth of Sofia Cambor Jameson<sup>15</sup> in Santander, Cantabria, Spain, in 1993
14. Birth of Sarah Gardiner<sup>82</sup> in Craghead, Co.Durham, in 1914
18. Birth of Thomas Marsden<sup>126</sup> in Little Hulton, Bolton, Lancashire, England, in 1877
19. Death of Edward Walsh Roocroft<sup>119</sup> in Islington Brookfield, London, England, in 1960  
Birth of Christopher Brown<sup>38</sup>, in 1995
20. Birth of Linda Jane Jameson<sup>44</sup> in Bolton, Lancashire, England, in 1954
21. Marriage of James Jameson<sup>251</sup> and Mary Woods<sup>252</sup> in Upholland, St Thomas, Lancashire, England, in 1777
22. Birth of Peter Jameson<sup>186</sup> in Wigan, Lancashire, England, in 1800
23. Death of Donald Templeman Jameson<sup>87</sup> in Thornton Cleveleys, Lancashire, England, in 2005
27. Birth of Catherine Callister<sup>254</sup> in Michael, Isle of Man, Isle of Man, United Kingdom, in 1695  
Death of Jane Elizabeth Woods<sup>42</sup> in Alyth, Perthshire, Scotland, in 2024
29. Death of Margaret Cowley<sup>217</sup> in Patrick Isle Of Man, in 1783  
Baptism of Robert Marsden<sup>210</sup> in Horwich, Lancashire, England, in 1790  
Birth of Ellen Jameson<sup>141</sup> in Wigan, Lancashire, England, in 1845  
Birth of Mary Elizabeth Corris<sup>134</sup> in Tranmere, Cheshire, England, in 1846  
Death of Ann Batteram<sup>225</sup> in 1670580, Lincolnshire, England, in 1852  
Death of Jane Corris Jameson<sup>104</sup> in Lancashire, United Kingdom, in 1886  
Death of Mary Elizabeth Corris<sup>134</sup> in Bolton, Lancashire, England, in 1906  
Death of Elizabeth Evelyne Best<sup>138</sup> in Warrington, Lancashire, England, in 1923  
Residence of Andrew John Jameson<sup>40</sup> in Stornoway, Scotland, in 1975  
Residence of Andrew John Jameson<sup>40</sup> in Appleshaw, Hampshire, England, in 1985  
Residence of Andrew John Jameson<sup>40</sup> in Chorlton cum Hardy, Lancashire, England, in 1999

**OCTOBER**

5. Death of Peter Jameson<sup>179</sup> in Wigan, Lancashire, England, in 1919  
Marriage of James Roocroft<sup>101</sup> and Dora Marsden Atkinson<sup>102</sup> in Bolton, Lancashire, England, in 1927
8. Birth of James Roocroft<sup>101</sup> in Bolton, Lancashire, England, in 1897  
Birth of Brenda Jameson<sup>84</sup> in Bolton, Lancashire, England, in 1921
10. Birth of Elizabeth Cowin<sup>190</sup> in Isle of Man, in 1773  
Marriage of Michael Lee Slack<sup>9</sup> and Rachel Jane Watts<sup>8</sup> in London Zoo, Westminster, London, England, in 2015
13. Baptism of Peter Jameson<sup>186</sup> in Wigan, All Saints, Lancashire, England, in 1800
14. Birth of Margaret Jameson<sup>48</sup> in Farnworth, Lancashire, in 1940
19. Burial of Patrick Corris<sup>253</sup> in Patrick, Isle of Man, in 1785
21. Birth of James Roocroft<sup>257</sup> in Ulnes Walton, Lancashire, in 1725  
Death of Sarah Hodson<sup>209</sup> in Bolton, Lancashire, England, in 1835  
Residence of Andrew John Jameson<sup>40</sup> in Alyth, Perthshire, Scotland, in 2021
24. Birth of Janik Jablonski<sup>85</sup> in Vilna Poland, in 1912  
Marriage of Janik Jablonski<sup>85</sup> and Brenda Jameson<sup>84</sup> in Westminster, Middlesex, United Kingdom, in 1944
28. Birth of Rebecca Payne<sup>198</sup> in Warkton, Northamptonshire, England, in 1788
29. Death of James Roocroft<sup>257</sup> in Ulnes Walton, Croston, Lancashire, in 1763  
Birth of William Brayshaw<sup>238</sup> in Horton In Ribblesdale, Yorkshire, England, in 1764  
Death of Margaret Jameson<sup>214</sup>, in 1818  
Death of John Cobb<sup>197</sup> in Wellingborough, Northamptonshire, United Kingdom, in 1872  
Marriage of Robert Marsden<sup>155</sup> and Martha Wilkinson<sup>156</sup> in Bolton Lancashire, in 1876  
Death of James Altham Batty<sup>203</sup> in Wakefield, Yorkshire West Riding, in 1878  
Marriage of John Atkinson<sup>139</sup> and Mary Ellen Marsden<sup>140</sup> in Bolton, Lancashire, England, in 1885  
Marriage of Charles Watkin Jones<sup>115</sup> in Bolton, Lancashire, England, in 1913  
Marriage of Albert George Wakefield<sup>111</sup> and Louisa (Kate) Catherine Templeman<sup>110</sup> in Bourne, Lincolnshire, United Kingdom, in 1916  
Death of Lucy Pendlebury<sup>127</sup> in Bolton, Lancashire, England, in 1923  
Death of Thomas Templeman<sup>135</sup> in Bourne, Lincolnshire, England, in 1938  
Death of Richard (Dick) Marsden<sup>138</sup>, in 1944  
Marriage of Albert Lord<sup>132</sup> and Elsie Marsden<sup>131</sup> in Bolton, Lancashire, England, in 1948  
Birth of Janina M A Jablonski<sup>56</sup> in Uxbridge, Middlesex, in 1949  
Birth of Andrew P Jablonski<sup>60</sup> in Lewisham, Greater London, in 1954  
Birth of Sheila Anne Jameson<sup>62</sup> in Farnworth, Lancashire, in 1954  
Birth of Jean S Jameson<sup>66</sup> in Bolton, Lancashire, England, in 1959  
Birth of Simon A Roocroft<sup>77</sup> in Bolton, Lancashire, England, in 1961  
Birth of Angela Ruth Jameson<sup>68</sup> in Farnworth, Lancashire, in 1968  
Birth of Jason Andrew O'Mara<sup>28</sup> in Wandsworth, London, in 1970  
Birth of Craig Antony O'Mara<sup>29</sup> in Wandsworth, London, in 1973  
Birth of Simon Andrew Jablonski<sup>33</sup> in Derby, Derbyshire, in 1979

**NOVEMBER**

2. Birth of Linda Camblor Jameson<sup>16</sup> in Santander, Cantabria, Spain, in 1995
3. Death of Mary Ellen Marsden<sup>140</sup> in Bolton, Lancashire, England, in 1915
4. Death of John Corris Jameson<sup>81</sup> in Withington Hospital, Manchester, in 1976
6. Death of Margaret Unknown<sup>266</sup> in Standishgate, Wigan, Lancashire, in 1801
7. Death of Jane Harrison<sup>164</sup> in Rock Ferry, Cheshire, England, United Kingdom, in 1878
8. Birth of Robert Templeman<sup>193</sup> in Market Deeping, Lincolnshire, England, in 1789
10. Burial of John Corris Jameson<sup>81</sup> in Lancashire, England, in 1976
11. Birth of Ian J Brown<sup>76</sup>, in 1959
13. Death of Clara Talbot<sup>147</sup> in Bolton, Lancashire, England, in 1957
16. Marriage of Simon Corris<sup>189</sup> and Elizabeth Cowin<sup>190</sup> in Kirk German, Isle of Man, England, in 1794  
Probate: Edward Dennis Jameson<sup>83</sup> in Llandudno, in 1944
17. Marriage of James Ashburn<sup>205</sup> and Elizabeth McAlpine<sup>206</sup> in Manchester, Lancashire, England, in 1835  
Birth of Cissie Marsden<sup>124</sup>, in 1916
19. Marriage of James Atkinson<sup>173</sup> and Jane Hodson<sup>174</sup> in Bolton-le-Moors, Lancashire, England, in 1856  
Birth of Catherine Jane Emerson<sup>10</sup> in Hackney, London, England, in 1992
20. Birth of Linda Charlotte Vickers<sup>17</sup> in Bolton, Lancashire, England, in 1985
24. Birth of Amelia Ann Jameson<sup>105</sup> in Patricroft, Lancashire, England, in 1884
27. Baptism of Ann Stimson<sup>180</sup> in Yarwell, Northampton, England, in 1814  
Birth of Peggy (Margaret) Huntington<sup>243</sup> in Nateby, Lancashire, England, in 1769

**DECEMBER**

4. Death of John Roocroft<sup>232</sup> in Ulnes Walton, Croston, Lancashire, in 1801
5. Death of Peter Marsden<sup>244</sup> in Halliwell, Lancashire, in 1825
8. Death of Roy Wardle<sup>49</sup> in Bolton, Lancashire, England, in 2012
9. Birth of Catherine Charlotte Atkinson<sup>202</sup> in Milnthorpe, Westmorland, England, in 1798  
Baptism of Muriel Irene Jones<sup>92</sup> in Bolton, Lancashire, England, in 1917
16. Birth of Dora Marsden Atkinson<sup>102</sup> in Bolton, Lancashire, England, in 1899  
Death of John Marsden Roocroft<sup>89</sup>, in 2010
20. Birth of Jane Harrison<sup>164</sup> in Tranmere, Cheshire, England, in 1816
21. Death of Irene Elizabeth McDonald Brock<sup>98</sup>, in 2019
24. Death of Dora Marsden Atkinson<sup>102</sup> in Bolton, Lancashire, England, in 1981
25. Death of Emma Templeman<sup>100</sup> in Bolton, Lancashire, England, in 1966
29. Birth of Donald Templeman Jameson<sup>87</sup> in Bolton, Lancashire, England, in 1924
30. Death of Paul Thomas O'Mara<sup>55</sup>, in 2010
31. Death of Simon Corris<sup>189</sup> in Patrick Isle Of Man, in 1841  
Death of Catherine Charlotte Atkinson<sup>202</sup> in Preston, Lancashire, England, United Kingdom, in 1866  
Death of Henry Atkinson<sup>149</sup> in Bolton, Lancashire, England, in 1896  
Marriage of John Corris Jameson<sup>81</sup> and Sarah Gardiner<sup>82</sup> in Craghead, Durham, England, in 1939  
Burial of Dora Marsden Atkinson<sup>102</sup> in Lancashire, England, in 1981
- Birth of William Templeman<sup>165</sup> in Market Deeping, Lincolnshire, in 1822
- Death of George Harwood<sup>247</sup> in Bolton Lancashire 21 / 122, in 1839
- Death of Katharine Prickett<sup>235</sup> in Westmorland, in 1852
- Death of Frances (Fanny) Hadkin<sup>187</sup> in Haigh, Wigan, Lancashire, England, in 1858
- Birth of Fanny Elizabeth Jameson<sup>143</sup> in Haigh, Lancashire, England, in 1859
- Birth of William Corris Jameson<sup>103</sup> in Rock Ferry, Cheshire, England, in 1878
- Death of Edward Corris<sup>163</sup> in Birkenhead, Cheshire, England, in 1893
- Death of Robert Marsden<sup>155</sup> in Lancashire, United Kingdom, in 1904
- Death of Mary Ann Ashburn<sup>172</sup> in Salford, Lancashire, England, in 1922
- Birth of Robert Bryan Jameson<sup>79</sup> in Bolton, Lancashire, England, in 1926
- Death of Ernest Croft Wood<sup>121</sup> in Prescott, Lancashire, England, in 1973
- Marriage of Andrew John Jameson<sup>40</sup> and Judith Anne Whitehurst<sup>41</sup> in Bolton, Lancashire, England, in 1977

## 10. RELATIONSHIP PATHS

This section details the relationship of each connected individual to Andrew John Jameson.

To facilitate cross-referencing, the relationship reference number in this section is shown with the relationship description within the other sections.

### **IMMEDIATE FAMILY**

1. ROBERT BRYAN JAMESON<sup>79</sup>. Father
2. MARY ATKINSON ROOCROFT<sup>80</sup>. Mother
3. LINDA JANE JAMESON<sup>44</sup>. Sister
4. KATHRYN MARY JAMESON<sup>46</sup>. Sister
5. SALLY EMERSON<sup>43</sup>. Wife
6. JANE ELIZABETH WOODS<sup>42</sup>. Wife
7. JUDITH ANNE WHITEHURST<sup>41</sup>. Wife
8. ROBERT CAMERON JAMESON<sup>7</sup>. Son
9. JOHN ROSS JAMESON<sup>6</sup>. Son
10. CATHERINE JANE EMERSON<sup>10</sup>. Daughter
11. RACHEL JANE WATTS<sup>8</sup>. Daughter

### **1 STEP REMOVED**

12. EDWARD CORRIS JAMESON<sup>99</sup>. Father of Robert Bryan Jameson, father
13. EMMA TEMPLEMAN<sup>100</sup>. Mother of Robert Bryan Jameson, father
14. JOHN CORRIS JAMESON<sup>81</sup>. Brother of Robert Bryan Jameson, father
15. EDWARD DENNIS JAMESON<sup>83</sup>. Brother of Robert Bryan Jameson, father
16. DONALD TEMPLEMAN JAMESON<sup>87</sup>. Brother of Robert Bryan Jameson, father
17. KATHLEEN NINA JAMESON<sup>86</sup>. Sister of Robert Bryan Jameson, father
18. BRENDA JAMESON<sup>84</sup>. Sister of Robert Bryan Jameson, father
19. JAMES ROOCROFT<sup>101</sup>. Father of Mary Atkinson Roocroft, mother
20. DORA MARSDEN ATKINSON<sup>102</sup>. Mother of Mary Atkinson Roocroft, mother
21. JOHN MARSDEN ROOCROFT<sup>89</sup>. Brother of Mary Atkinson Roocroft, mother
22. WILLIAM LESLIE VICKERS<sup>47</sup>. Husband of Kathryn Mary Jameson, sister
23. CÉSAR CAMBLOR<sup>45</sup>. Husband of Linda Jane Jameson, sister
24. NICHOLAS CAMBLOR JAMESON<sup>13</sup>. Son of Linda Jane Jameson, sister
25. THOMAS WILLIAM VICKERS<sup>19</sup>. Son of Kathryn Mary Jameson, sister
26. BENJAMIN JAMES VICKERS<sup>20</sup>. Son of Kathryn Mary Jameson, sister
27. MATEO CAMBLOR JAMESON<sup>14</sup>. Son of Linda Jane Jameson, sister
28. ROBERTO CAMBLOR JAMESON<sup>12</sup>. Son of Linda Jane Jameson, sister
29. LINDA CHARLOTTE VICKERS<sup>17</sup>. Daughter of Kathryn Mary Jameson, sister
30. SOFIA CAMBLOR JAMESON<sup>15</sup>. Daughter of Linda Jane Jameson, sister
31. LINDA CAMBLOR JAMESON<sup>16</sup>. Daughter of Linda Jane Jameson, sister
32. MICHAEL LEE SLACK<sup>9</sup>. Husband of Rachel Jane Watts, daughter
33. RICHARD MANU<sup>11</sup>. Husband of Catherine Jane Emerson, daughter

### **2 STEPS REMOVED**

34. JOHN JAMESON<sup>133</sup>. Father of Edward Corris Jameson, father of Robert Bryan Jameson, father
35. MARY ELIZABETH CORRIS<sup>134</sup>. Mother of Edward Corris Jameson, father of Robert Bryan Jameson, father
36. WILLIAM CORRIS JAMESON<sup>103</sup>. Brother of Edward Corris Jameson, father of Robert Bryan Jameson, father
37. JOHN JAMESON<sup>107</sup>. Brother of Edward Corris Jameson, father of Robert Bryan Jameson, father
38. AMELIA ANN JAMESON<sup>105</sup>. Sister of Edward Corris Jameson, father of Robert Bryan Jameson, father
39. JANE CORRIS JAMESON<sup>104</sup>. Sister of Edward Corris Jameson, father of Robert Bryan Jameson, father
40. THOMAS TEMPLEMAN<sup>135</sup>. Father of Emma Templeman, mother of Robert Bryan Jameson, father
41. JANE COBB<sup>136</sup>. Mother of Emma Templeman, mother of Robert Bryan Jameson, father
42. AMOS STIMSON TEMPLEMAN<sup>108</sup>. Brother of Emma Templeman, mother of Robert Bryan Jameson, father
43. LOUISA (KATE) CATHERINE TEMPLEMAN<sup>110</sup>. Sister of Emma Templeman, mother of Robert Bryan Jameson, father
44. EDITH TEMPLEMAN<sup>112</sup>. Sister of Emma Templeman, mother of Robert Bryan Jameson, father
45. SARAH GARDINER<sup>82</sup>. Wife of John Corris Jameson, brother of Robert Bryan Jameson, father
46. SHEILA SANDERSON<sup>88</sup>. Wife of Donald Templeman Jameson, brother of Robert Bryan Jameson, father
47. IAN ROBERT JAMESON<sup>70</sup>. Son of Donald Templeman Jameson, brother of Robert Bryan Jameson, father
48. PETER M JAMESON<sup>65</sup>. Son of Donald Templeman Jameson, brother of Robert Bryan Jameson, father
49. RICHARD D JAMESON<sup>64</sup>. Son of Donald Templeman Jameson, brother of Robert Bryan Jameson, father
50. SUSAN D JAMESON<sup>50</sup>. Daughter of John Corris Jameson, brother of Robert Bryan Jameson, father
51. ANGELA RUTH JAMESON<sup>68</sup>. Daughter of Donald Templeman Jameson, brother of Robert Bryan Jameson, father

**2 STEPS REMOVED (Continued)**

52. MARGARET JAMESON<sup>148</sup>. Daughter of John Corris Jameson, brother of Robert Bryan Jameson, father
53. JEAN S JAMESON<sup>166</sup>. Daughter of Donald Templeman Jameson, brother of Robert Bryan Jameson, father
54. ELIZABETH H JAMESON<sup>67</sup>. Daughter of Donald Templeman Jameson, brother of Robert Bryan Jameson, father
55. SHEILA ANNE JAMESON<sup>62</sup>. Daughter of Donald Templeman Jameson, brother of Robert Bryan Jameson, father
56. JANIK JABLONSKI<sup>85</sup>. Husband of Brenda Jameson, sister of Robert Bryan Jameson, father
57. JOHN E JABLONSKI<sup>52</sup>. Son of Brenda Jameson, sister of Robert Bryan Jameson, father
58. ANDREW P JABLONSKI<sup>60</sup>. Son of Brenda Jameson, sister of Robert Bryan Jameson, father
59. DENNIS C JABLONSKI<sup>58</sup>. Son of Brenda Jameson, sister of Robert Bryan Jameson, father
60. EDWINA M JABLONSKI<sup>54</sup>. Daughter of Brenda Jameson, sister of Robert Bryan Jameson, father
61. JANINA M A JABLONSKI<sup>56</sup>. Daughter of Brenda Jameson, sister of Robert Bryan Jameson, father
62. ROBERT ROOCROFT<sup>137</sup>. Father of James Roocroft, father of Mary Atkinson Roocroft, mother
63. ELIZABETH EVELYNE BEST<sup>138</sup>. Mother of James Roocroft, father of Mary Atkinson Roocroft, mother
64. THOMAS HAROLD ROOCROFT<sup>118</sup>. Brother of James Roocroft, father of Mary Atkinson Roocroft, mother
65. WILLIAM ROOCROFT<sup>113</sup>. Brother of James Roocroft, father of Mary Atkinson Roocroft, mother
66. EDWARD WALSH ROOCROFT<sup>119</sup>. Brother of James Roocroft, father of Mary Atkinson Roocroft, mother
67. ALICE ROOCROFT<sup>114</sup>. Sister of James Roocroft, father of Mary Atkinson Roocroft, mother
68. ETHEL ROOCROFT<sup>116</sup>. Sister of James Roocroft, father of Mary Atkinson Roocroft, mother
69. JOHN ATKINSON<sup>139</sup>. Father of Dora Marsden Atkinson, mother of Mary Atkinson Roocroft, mother
70. MARY ELLEN MARSDEN<sup>140</sup>. Mother of Dora Marsden Atkinson, mother of Mary Atkinson Roocroft, mother
71. LINDA MARSDEN ATKINSON<sup>120</sup>. Sister of Dora Marsden Atkinson, mother of Mary Atkinson Roocroft, mother
72. JOAN HADDOCK<sup>90</sup>. Wife of John Marsden Roocroft, brother of Mary Atkinson Roocroft, mother
73. DAVID J ROOCROFT<sup>71</sup>. Son of John Marsden Roocroft, brother of Mary Atkinson Roocroft, mother
74. CAROLINE ROOCROFT<sup>72</sup>. Daughter of John Marsden Roocroft, brother of Mary Atkinson Roocroft, mother
75. ADAM BAIRD-FRASER<sup>18</sup>. Husband of Linda Charlotte Vickers, daughter of Kathryn Mary Jameson, sister

**3 STEPS REMOVED**

76. WILLIAM JAMESON<sup>161</sup>. Father of John Jameson, father of Edward Corris Jameson, father of Robert Bryan Jameson, father
77. ELIZABETH ARROWSMITH<sup>162</sup>. Mother of John Jameson, father of Edward Corris Jameson, father of Robert Bryan Jameson, father
78. MARY JAMESON<sup>142</sup>. Sister of John Jameson, father of Edward Corris Jameson, father of Robert Bryan Jameson, father
79. FANNY ELIZABETH JAMESON<sup>143</sup>. Sister of John Jameson, father of Edward Corris Jameson, father of Robert Bryan Jameson, father
80. ELLEN JAMESON<sup>141</sup>. Sister of John Jameson, father of Edward Corris Jameson, father of Robert Bryan Jameson, father
81. EDWARD CORRIS<sup>163</sup>. Father of Mary Elizabeth Corris, mother of Edward Corris Jameson, father of Robert Bryan Jameson, father
82. JANE HARRISON<sup>164</sup>. Mother of Mary Elizabeth Corris, mother of Edward Corris Jameson, father of Robert Bryan Jameson, father
83. GEORGE O A SELLEN<sup>106</sup>. Husband of Amelia Ann Jameson, sister of Edward Corris Jameson, father of Robert Bryan Jameson, father
84. WILLIAM TEMPLEMAN<sup>165</sup>. Father of Thomas Templeman, father of Emma Templeman, mother of Robert Bryan Jameson, father
85. ANN ALLEN<sup>166</sup>. Mother of Thomas Templeman, father of Emma Templeman, mother of Robert Bryan Jameson, father
86. WILLIAM TEMPLEMAN<sup>144</sup>. Brother of Thomas Templeman, father of Emma Templeman, mother of Robert Bryan Jameson, father
87. HENRY TEMPLEMAN<sup>145</sup>. Brother of Thomas Templeman, father of Emma Templeman, mother of Robert Bryan Jameson, father
88. AMOS COBB<sup>167</sup>. Father of Jane Cobb, mother of Emma Templeman, mother of Robert Bryan Jameson, father
89. JANE STIMSON<sup>168</sup>. Mother of Jane Cobb, mother of Emma Templeman, mother of Robert Bryan Jameson, father
90. KATHERINE SARGEANT<sup>109</sup>. Wife of Amos Stimson Templeman, brother of Emma Templeman, mother of Robert Bryan Jameson, father
91. ALBERT GEORGE WAKEFIELD<sup>111</sup>. Husband of Louisa (Kate) Catherine Templeman, sister of Emma Templeman, mother of Robert Bryan Jameson, father
92. AUDREY TEMPLEMAN<sup>91</sup>. Daughter of Edith Templeman, sister of Emma Templeman, mother of Robert Bryan Jameson, father
93. DAVID A B POTTS<sup>69</sup>. Husband of Angela Ruth Jameson, daughter of Donald Templeman Jameson, brother of Robert Bryan Jameson, father

**3 STEPS REMOVED (Continued)**

94. ROY WARDLE<sup>49</sup>. Husband of Margaret Jameson, daughter of John Corris Jameson, brother of Robert Bryan Jameson, father
95. PHILIP BOOTH<sup>63</sup>. Husband of Sheila Anne Jameson, daughter of Donald Templeman Jameson, brother of Robert Bryan Jameson, father
96. MEL SOMERSALL<sup>51</sup>. Husband of Susan D Jameson, daughter of John Corris Jameson, brother of Robert Bryan Jameson, father
97. TIMOTHY JAMES WARDLE<sup>24</sup>. Son of Margaret Jameson, daughter of John Corris Jameson, brother of Robert Bryan Jameson, father
98. ROBIN MARCUS WARDLE<sup>21</sup>. Son of Margaret Jameson, daughter of John Corris Jameson, brother of Robert Bryan Jameson, father
99. EDWARD JONATHAN WARDLE<sup>23</sup>. Son of Margaret Jameson, daughter of John Corris Jameson, brother of Robert Bryan Jameson, father
100. JAMES RICHARD SOMERSALL<sup>26</sup>. Son of Susan D Jameson, daughter of John Corris Jameson, brother of Robert Bryan Jameson, father
101. CATHERINE R WARMINGTON<sup>53</sup>. Wife of John E Jablonski, son of Brenda Jameson, sister of Robert Bryan Jameson, father
102. ANNE J CRAWLEY<sup>61</sup>. Wife of Andrew P Jablonski, son of Brenda Jameson, sister of Robert Bryan Jameson, father
103. LAURA E SLATER<sup>59</sup>. Wife of Dennis C Jablonski, son of Brenda Jameson, sister of Robert Bryan Jameson, father
104. ROBERT ANTHONY JABLONSKI<sup>35</sup>. Son of Andrew P Jablonski, son of Brenda Jameson, sister of Robert Bryan Jameson, father
105. SIMON ANDREW JABLONSKI<sup>33</sup>. Son of Andrew P Jablonski, son of Brenda Jameson, sister of Robert Bryan Jameson, father
106. TIMOTHY JOHN JABLONSKI<sup>34</sup>. Son of Andrew P Jablonski, son of Brenda Jameson, sister of Robert Bryan Jameson, father
107. PAULINE ANNE JABLONSKI<sup>32</sup>. Daughter of Andrew P Jablonski, son of Brenda Jameson, sister of Robert Bryan Jameson, father
108. NEIL MCLAREN<sup>27</sup>. Husband of Janina M A Jablonski, daughter of Brenda Jameson, sister of Robert Bryan Jameson, father
109. PAUL THOMAS O'MARA<sup>55</sup>. Husband of Edwina M Jablonski, daughter of Brenda Jameson, sister of Robert Bryan Jameson, father
110. CRAIG ANTONY O'MARA<sup>29</sup>. Son of Edwina M Jablonski, daughter of Brenda Jameson, sister of Robert Bryan Jameson, father
111. SCOTT MCLAREN<sup>30</sup>. Son of Janina M A Jablonski, daughter of Brenda Jameson, sister of Robert Bryan Jameson, father
112. JASON ANDREW O'MARA<sup>28</sup>. Son of Edwina M Jablonski, daughter of Brenda Jameson, sister of Robert Bryan Jameson, father
113. AMY MCLAREN<sup>31</sup>. Daughter of Janina M A Jablonski, daughter of Brenda Jameson, sister of Robert Bryan Jameson, father
114. EDWARD ROOCROFT<sup>169</sup>. Father of Robert Roocroft, father of James Roocroft, father of Mary Atkinson Roocroft, mother
115. MARY BATTY<sup>170</sup>. Mother of Robert Roocroft, father of James Roocroft, father of Mary Atkinson Roocroft, mother
116. WILLIAM ROOCROFT<sup>146</sup>. Brother of Robert Roocroft, father of James Roocroft, father of Mary Atkinson Roocroft, mother
117. THOMAS WALSH BEST<sup>171</sup>. Father of Elizabeth Evelyne Best, mother of James Roocroft, father of Mary Atkinson Roocroft, mother
118. MARY ANN ASHBURN<sup>172</sup>. Mother of Elizabeth Evelyne Best, mother of James Roocroft, father of Mary Atkinson Roocroft, mother
119. HERBERT CAMPBELL<sup>117</sup>. Husband of Ethel Roocroft, sister of James Roocroft, father of Mary Atkinson Roocroft, mother
120. CHARLES WATKIN JONES<sup>115</sup>. Husband of Alice Roocroft, sister of James Roocroft, father of Mary Atkinson Roocroft, mother
121. MURIEL IRENE JONES<sup>92</sup>. Daughter of Alice Roocroft, sister of James Roocroft, father of Mary Atkinson Roocroft, mother
122. JAMES ATKINSON<sup>173</sup>. Father of John Atkinson, father of Dora Marsden Atkinson, mother of Mary Atkinson Roocroft, mother
123. JANE HODSON<sup>174</sup>. Mother of John Atkinson, father of Dora Marsden Atkinson, mother of Mary Atkinson Roocroft, mother
124. HENRY ATKINSON<sup>149</sup>. Brother of John Atkinson, father of Dora Marsden Atkinson, mother of Mary Atkinson Roocroft, mother
125. MARY ATKINSON<sup>148</sup>. Sister of John Atkinson, father of Dora Marsden Atkinson, mother of Mary Atkinson Roocroft, mother

**3 STEPS REMOVED (Continued)**

126. ELIZABETH ATKINSON<sup>151</sup>. Sister of John Atkinson, father of Dora Marsden Atkinson, mother of Mary Atkinson Roocroft, mother
127. EDITH ATKINSON<sup>152</sup>. Sister of John Atkinson, father of Dora Marsden Atkinson, mother of Mary Atkinson Roocroft, mother
128. ISABELLA ATKINSON<sup>150</sup>. Sister of John Atkinson, father of Dora Marsden Atkinson, mother of Mary Atkinson Roocroft, mother
129. THOMAS MARSDEN<sup>176</sup>. Father of Mary Ellen Marsden, mother of Dora Marsden Atkinson, mother of Mary Atkinson Roocroft, mother
130. ELIZABETH (BETTY) BOLTON<sup>177</sup>. Mother of Mary Ellen Marsden, mother of Dora Marsden Atkinson, mother of Mary Atkinson Roocroft, mother
131. RICHARD (DICK) MARSDEN<sup>158</sup>. Brother of Mary Ellen Marsden, mother of Dora Marsden Atkinson, mother of Mary Atkinson Roocroft, mother
132. WILLIAM THOMAS MARSDEN<sup>153</sup>. Brother of Mary Ellen Marsden, mother of Dora Marsden Atkinson, mother of Mary Atkinson Roocroft, mother
133. ROBERT MARSDEN<sup>155</sup>. Brother of Mary Ellen Marsden, mother of Dora Marsden Atkinson, mother of Mary Atkinson Roocroft, mother
134. JOHN MARSDEN<sup>157</sup>. Brother of Mary Ellen Marsden, mother of Dora Marsden Atkinson, mother of Mary Atkinson Roocroft, mother
135. JAMES MARSDEN<sup>154</sup>. Brother of Mary Ellen Marsden, mother of Dora Marsden Atkinson, mother of Mary Atkinson Roocroft, mother
136. ERNEST CROFT WOOD<sup>121</sup>. Husband of Linda Marsden Atkinson, sister of Dora Marsden Atkinson, mother of Mary Atkinson Roocroft, mother
137. JOHN DEREK WOOD<sup>95</sup>. Son of Linda Marsden Atkinson, sister of Dora Marsden Atkinson, mother of Mary Atkinson Roocroft, mother
138. MARGARET LINDA WOOD<sup>93</sup>. Daughter of Linda Marsden Atkinson, sister of Dora Marsden Atkinson, mother of Mary Atkinson Roocroft, mother

**4 STEPS REMOVED**

139. PETER JAMESON<sup>186</sup>. Father of William Jameson, father of John Jameson, father of Edward Corris Jameson, father of Robert Bryan Jameson, father
140. FRANCES (FANNY) HADKIN<sup>187</sup>. Mother of William Jameson, father of John Jameson, father of Edward Corris Jameson, father of Robert Bryan Jameson, father
141. PETER JAMESON<sup>179</sup>. Brother of William Jameson, father of John Jameson, father of Edward Corris Jameson, father of Robert Bryan Jameson, father
142. JANE JAMESON<sup>178</sup>. Sister of William Jameson, father of John Jameson, father of Edward Corris Jameson, father of Robert Bryan Jameson, father
143. JOHN ARROWSMITH<sup>188</sup>. Father of Elizabeth Arrowsmith, mother of John Jameson, father of Edward Corris Jameson, father of Robert Bryan Jameson, father
144. SIMON CORRIS<sup>189</sup>. Father of Edward Corris, father of Mary Elizabeth Corris, mother of Edward Corris Jameson, father of Robert Bryan Jameson, father
145. ELIZABETH COWIN<sup>190</sup>. Mother of Edward Corris, father of Mary Elizabeth Corris, mother of Edward Corris Jameson, father of Robert Bryan Jameson, father
146. RICHARD HARRISON<sup>191</sup>. Father of Jane Harrison, mother of Mary Elizabeth Corris, mother of Edward Corris Jameson, father of Robert Bryan Jameson, father
147. MARY OXTON<sup>192</sup>. Mother of Jane Harrison, mother of Mary Elizabeth Corris, mother of Edward Corris Jameson, father of Robert Bryan Jameson, father
148. ROBERT TEMPLEMAN<sup>193</sup>. Father of William Templeman, father of Thomas Templeman, father of Emma Templeman, mother of Robert Bryan Jameson, father
149. MARY REEDMAN<sup>194</sup>. Mother of William Templeman, father of Thomas Templeman, father of Emma Templeman, mother of Robert Bryan Jameson, father
150. ROBERT ALLEN<sup>195</sup>. Father of Ann Allen, mother of Thomas Templeman, father of Emma Templeman, mother of Robert Bryan Jameson, father
151. ANN BRIGGS<sup>196</sup>. Mother of Ann Allen, mother of Thomas Templeman, father of Emma Templeman, mother of Robert Bryan Jameson, father
152. JOHN COBB<sup>197</sup>. Father of Amos Cobb, father of Jane Cobb, mother of Emma Templeman, mother of Robert Bryan Jameson, father
153. REBECCA PAYNE<sup>198</sup>. Mother of Amos Cobb, father of Jane Cobb, mother of Emma Templeman, mother of Robert Bryan Jameson, father
154. WILLIAM STIMSON<sup>199</sup>. Father of Jane Stimson, mother of Jane Cobb, mother of Emma Templeman, mother of Robert Bryan Jameson, father
155. CATHERINE LATTIMORE<sup>200</sup>. Mother of Jane Stimson, mother of Jane Cobb, mother of Emma Templeman, mother of Robert Bryan Jameson, father
156. JOHN STIMSON<sup>182</sup>. Brother of Jane Stimson, mother of Jane Cobb, mother of Emma Templeman, mother of Robert Bryan Jameson, father

**4 STEPS REMOVED (Continued)**

157. ANN STIMSON<sup>180</sup>. Sister of Jane Stimson, mother of Jane Cobb, mother of Emma Templeman, mother of Robert Bryan Jameson, father
158. JACQUELINE A THORNES<sup>25</sup>. Wife of Timothy James Wardle, son of Margaret Jameson, daughter of John Corris Jameson, brother of Robert Bryan Jameson, father
159. PAULA ELIZABETH ANDERSON<sup>27</sup>. Wife of James Richard Somersall, son of Susan D Jameson, daughter of John Corris Jameson, brother of Robert Bryan Jameson, father
160. ELIZABETH J STONE<sup>22</sup>. Wife of Robin Marcus Wardle, son of Margaret Jameson, daughter of John Corris Jameson, brother of Robert Bryan Jameson, father
161. TRISTAN THOMAS SOMERSALL<sup>5</sup>. Son of James Richard Somersall, son of Susan D Jameson, daughter of John Corris Jameson, brother of Robert Bryan Jameson, father
162. MR. SOMERSALL<sup>3</sup>. Son of James Richard Somersall, son of Susan D Jameson, daughter of John Corris Jameson, brother of Robert Bryan Jameson, father
163. NATHAN JAMES SOMERSALL<sup>4</sup>. Son of James Richard Somersall, son of Susan D Jameson, daughter of John Corris Jameson, brother of Robert Bryan Jameson, father
164. MS. WARDLE<sup>2</sup>. Daughter of Timothy James Wardle, son of Margaret Jameson, daughter of John Corris Jameson, brother of Robert Bryan Jameson, father
165. MS. WARDLE<sup>1</sup>. Daughter of Timothy James Wardle, son of Margaret Jameson, daughter of John Corris Jameson, brother of Robert Bryan Jameson, father
166. RICHARD ROOCROFT<sup>201</sup>. Father of Edward Roocroft, father of Robert Roocroft, father of James Roocroft, father of Mary Atkinson Roocroft, mother
167. CATHERINE CHARLOTTE ATKINSON<sup>202</sup>. Mother of Edward Roocroft, father of Robert Roocroft, father of James Roocroft, father of Mary Atkinson Roocroft, mother
168. JAMES ALTHAM BATTY<sup>203</sup>. Father of Mary Batty, mother of Robert Roocroft, father of James Roocroft, father of Mary Atkinson Roocroft, mother
169. MARY ANN BRAYSHAW<sup>204</sup>. Mother of Mary Batty, mother of Robert Roocroft, father of James Roocroft, father of Mary Atkinson Roocroft, mother
170. CLARA TALBOT<sup>147</sup>. Wife of William Roocroft, brother of Robert Roocroft, father of James Roocroft, father of Mary Atkinson Roocroft, mother
171. ERIC TALBOT ROOCROFT<sup>122</sup>. Son of William Roocroft, brother of Robert Roocroft, father of James Roocroft, father of Mary Atkinson Roocroft, mother
172. JAMES ASHBURN<sup>205</sup>. Father of Mary Ann Ashburn, mother of Elizabeth Evelyne Best, mother of James Roocroft, father of Mary Atkinson Roocroft, mother
173. ELIZABETH MCALPINE<sup>206</sup>. Mother of Mary Ann Ashburn, mother of Elizabeth Evelyne Best, mother of James Roocroft, father of Mary Atkinson Roocroft, mother
174. CHRISTOPHER ATKINSON<sup>207</sup>. Father of James Atkinson, father of John Atkinson, father of Dora Marsden Atkinson, mother of Mary Atkinson Roocroft, mother
175. MARY WRIGHT<sup>208</sup>. Mother of James Atkinson, father of John Atkinson, father of Dora Marsden Atkinson, mother of Mary Atkinson Roocroft, mother
176. SARAH HODSON<sup>209</sup>. Mother of Jane Hodson, mother of John Atkinson, father of Dora Marsden Atkinson, mother of Mary Atkinson Roocroft, mother
177. MATTHEW LOFTHOUSE<sup>175</sup>. Husband of Jane Hodson, mother of John Atkinson, father of Dora Marsden Atkinson, mother of Mary Atkinson Roocroft, mother
178. ROBERT MARSDEN<sup>210</sup>. Father of Thomas Marsden, father of Mary Ellen Marsden, mother of Dora Marsden Atkinson, mother of Mary Atkinson Roocroft, mother
179. MARY BIBBY<sup>211</sup>. Mother of Thomas Marsden, father of Mary Ellen Marsden, mother of Dora Marsden Atkinson, mother of Mary Atkinson Roocroft, mother
180. JOHN BOLTON<sup>212</sup>. Father of Elizabeth (Betty) Bolton, mother of Mary Ellen Marsden, mother of Dora Marsden Atkinson, mother of Mary Atkinson Roocroft, mother
181. SARAH MORRIS<sup>213</sup>. Mother of Elizabeth (Betty) Bolton, mother of Mary Ellen Marsden, mother of Dora Marsden Atkinson, mother of Mary Atkinson Roocroft, mother
182. HANNAH BOLTON<sup>185</sup>. Sister of Elizabeth (Betty) Bolton, mother of Mary Ellen Marsden, mother of Dora Marsden Atkinson, mother of Mary Atkinson Roocroft, mother
183. SARAH BOLTON<sup>184</sup>. Sister of Elizabeth (Betty) Bolton, mother of Mary Ellen Marsden, mother of Dora Marsden Atkinson, mother of Mary Atkinson Roocroft, mother
184. AMY ANN WOODWARD<sup>159</sup>. Wife of Richard (Dick) Marsden, brother of Mary Ellen Marsden, mother of Dora Marsden Atkinson, mother of Mary Atkinson Roocroft, mother
185. MARTHA WILKINSON<sup>156</sup>. Wife of Robert Marsden, brother of Mary Ellen Marsden, mother of Dora Marsden Atkinson, mother of Mary Atkinson Roocroft, mother
186. THOMAS MARSDEN<sup>126</sup>. Son of Robert Marsden, brother of Mary Ellen Marsden, mother of Dora Marsden Atkinson, mother of Mary Atkinson Roocroft, mother
187. EDITH MARSDEN<sup>128</sup>. Daughter of Richard (Dick) Marsden, brother of Mary Ellen Marsden, mother of Dora Marsden Atkinson, mother of Mary Atkinson Roocroft, mother
188. CISSIE MARSDEN<sup>124</sup>. Daughter of Robert Marsden, brother of Mary Ellen Marsden, mother of Dora Marsden Atkinson, mother of Mary Atkinson Roocroft, mother

**4 STEPS REMOVED (Continued)**

189. ELSIE MARSDEN<sup>131</sup>. Daughter of Richard (Dick) Marsden, brother of Mary Ellen Marsden, mother of Dora Marsden Atkinson, mother of Mary Atkinson Roocroft, mother
190. MARY (POLLY) ELIZABETH MARSDEN<sup>129</sup>. Daughter of Richard (Dick) Marsden, brother of Mary Ellen Marsden, mother of Dora Marsden Atkinson, mother of Mary Atkinson Roocroft, mother
191. BARBARA E BIBBY<sup>96</sup>. Wife of John Derek Wood, son of Linda Marsden Atkinson, sister of Dora Marsden Atkinson, mother of Mary Atkinson Roocroft, mother
192. LESLIE JAMES HARWOOD<sup>94</sup>. Husband of Margaret Linda Wood, daughter of Linda Marsden Atkinson, sister of Dora Marsden Atkinson, mother of Mary Atkinson Roocroft, mother
193. JUDITH HARWOOD<sup>75</sup>. Daughter of Margaret Linda Wood, daughter of Linda Marsden Atkinson, sister of Dora Marsden Atkinson, mother of Mary Atkinson Roocroft, mother
194. CAROLYN ANNE HARWOOD<sup>73</sup>. Daughter of Margaret Linda Wood, daughter of Linda Marsden Atkinson, sister of Dora Marsden Atkinson, mother of Mary Atkinson Roocroft, mother

**5 STEPS REMOVED**

195. MARGARET JAMESON<sup>214</sup>. Mother of Peter Jameson, father of William Jameson, father of John Jameson, father of Edward Corris Jameson, father of Robert Bryan Jameson, father
196. WILLIAM CORRIS<sup>216</sup>. Father of Simon Corris, father of Edward Corris, father of Mary Elizabeth Corris, mother of Edward Corris Jameson, father of Robert Bryan Jameson, father
197. MARGARET COWLEY<sup>217</sup>. Mother of Simon Corris, father of Edward Corris, father of Mary Elizabeth Corris, mother of Edward Corris Jameson, father of Robert Bryan Jameson, father
198. THOMAS COWIN<sup>218</sup>. Father of Elizabeth Cowin, mother of Edward Corris, father of Mary Elizabeth Corris, mother of Edward Corris Jameson, father of Robert Bryan Jameson, father
199. ELIZABETH CLAGUE<sup>219</sup>. Mother of Elizabeth Cowin, mother of Edward Corris, father of Mary Elizabeth Corris, mother of Edward Corris Jameson, father of Robert Bryan Jameson, father
200. THOMAS OXTON<sup>220</sup>. Father of Mary Oxton, mother of Jane Harrison, mother of Mary Elizabeth Corris, mother of Edward Corris Jameson, father of Robert Bryan Jameson, father
201. JANE MIDDLETON<sup>221</sup>. Mother of Mary Oxton, mother of Jane Harrison, mother of Mary Elizabeth Corris, mother of Edward Corris Jameson, father of Robert Bryan Jameson, father
202. WILLIAM ROY TEMPLEMAN<sup>222</sup>. Father of Robert Templeman, father of William Templeman, father of Thomas Templeman, father of Emma Templeman, mother of Robert Bryan Jameson, father
203. BETTY MARY SCHWAB<sup>223</sup>. Mother of Robert Templeman, father of William Templeman, father of Thomas Templeman, father of Emma Templeman, mother of Robert Bryan Jameson, father
204. ROBERT REEDMAN<sup>224</sup>. Father of Mary Reedman, mother of William Templeman, father of Thomas Templeman, father of Emma Templeman, mother of Robert Bryan Jameson, father
205. ANN BATTERAM<sup>225</sup>. Mother of Mary Reedman, mother of William Templeman, father of Thomas Templeman, father of Emma Templeman, mother of Robert Bryan Jameson, father
206. WILLIAM COBB<sup>226</sup>. Father of John Cobb, father of Amos Cobb, father of Jane Cobb, mother of Emma Templeman, mother of Robert Bryan Jameson, father
207. ELIZABETH BERRY<sup>227</sup>. Mother of John Cobb, father of Amos Cobb, father of Jane Cobb, mother of Emma Templeman, mother of Robert Bryan Jameson, father
208. WILLIAM WM PAYNE<sup>228</sup>. Father of Rebecca Payne, mother of Amos Cobb, father of Jane Cobb, mother of Emma Templeman, mother of Robert Bryan Jameson, father
209. ELIZABETH LEGGIN<sup>229</sup>. Mother of Rebecca Payne, mother of Amos Cobb, father of Jane Cobb, mother of Emma Templeman, mother of Robert Bryan Jameson, father
210. EDWARD GREEN LATTIMORE<sup>230</sup>. Father of Catherine Lattimore, mother of Jane Stimson, mother of Jane Cobb, mother of Emma Templeman, mother of Robert Bryan Jameson, father
211. ANN NORRIS<sup>231</sup>. Mother of Catherine Lattimore, mother of Jane Stimson, mother of Jane Cobb, mother of Emma Templeman, mother of Robert Bryan Jameson, father
212. SARAH POSNETTE<sup>183</sup>. Wife of John Stimson, brother of Jane Stimson, mother of Jane Cobb, mother of Emma Templeman, mother of Robert Bryan Jameson, father
213. JANE ANNE STIMSON<sup>160</sup>. Daughter of John Stimson, brother of Jane Stimson, mother of Jane Cobb, mother of Emma Templeman, mother of Robert Bryan Jameson, father
214. MR. PEASGOOD<sup>181</sup>. Husband of Ann Stimson, sister of Jane Stimson, mother of Jane Cobb, mother of Emma Templeman, mother of Robert Bryan Jameson, father
215. JOHN ROOCROFT<sup>232</sup>. Father of Richard Roocroft, father of Edward Roocroft, father of Robert Roocroft, father of James Roocroft, father of Mary Atkinson Roocroft, mother
216. ELIZABETH RIGBY<sup>233</sup>. Mother of Richard Roocroft, father of Edward Roocroft, father of Robert Roocroft, father of James Roocroft, father of Mary Atkinson Roocroft, mother
217. JOHN ATKINSON<sup>234</sup>. Father of Catherine Charlotte Atkinson, mother of Edward Roocroft, father of Robert Roocroft, father of James Roocroft, father of Mary Atkinson Roocroft, mother
218. KATHARINE PRICKETT<sup>235</sup>. Mother of Catherine Charlotte Atkinson, mother of Edward Roocroft, father of Robert Roocroft, father of James Roocroft, father of Mary Atkinson Roocroft, mother
219. THOMAS BATTY<sup>236</sup>. Father of James Altham Batty, father of Mary Batty, mother of Robert Roocroft, father of James Roocroft, father of Mary Atkinson Roocroft, mother

**5 STEPS REMOVED (Continued)**

220. ELIZABETH MOORE<sup>237</sup>. Mother of James Altham Batty, father of Mary Batty, mother of Robert Roocroft, father of James Roocroft, father of Mary Atkinson Roocroft, mother
221. WILLIAM BRAYSHAW<sup>238</sup>. Father of Mary Ann Brayshaw, mother of Mary Batty, mother of Robert Roocroft, father of James Roocroft, father of Mary Atkinson Roocroft, mother
222. ALICE DOWNHAM<sup>239</sup>. Mother of Mary Ann Brayshaw, mother of Mary Batty, mother of Robert Roocroft, father of James Roocroft, father of Mary Atkinson Roocroft, mother
223. AILEEN MARY KING<sup>123</sup>. Wife of Eric Talbot Roocroft, son of William Roocroft, brother of Robert Roocroft, father of James Roocroft, father of Mary Atkinson Roocroft, mother
224. DAVID EWART ROOCROFT<sup>97</sup>. Son of Eric Talbot Roocroft, son of William Roocroft, brother of Robert Roocroft, father of James Roocroft, father of Mary Atkinson Roocroft, mother
225. WILLIAM ATKINSON<sup>240</sup>. Father of Christopher Atkinson, father of James Atkinson, father of John Atkinson, father of Dora Marsden Atkinson, mother of Mary Atkinson Roocroft, mother
226. ISABELLA SUMMERS<sup>241</sup>. Mother of Christopher Atkinson, father of James Atkinson, father of John Atkinson, father of Dora Marsden Atkinson, mother of Mary Atkinson Roocroft, mother
227. THOMAS WRIGHT<sup>242</sup>. Father of Mary Wright, mother of James Atkinson, father of John Atkinson, father of Dora Marsden Atkinson, mother of Mary Atkinson Roocroft, mother
228. PEGGY (MARGARET) HUNTINGTON<sup>243</sup>. Mother of Mary Wright, mother of James Atkinson, father of John Atkinson, father of Dora Marsden Atkinson, mother of Mary Atkinson Roocroft, mother
229. PETER MARSDEN<sup>244</sup>. Father of Robert Marsden, father of Thomas Marsden, father of Mary Ellen Marsden, mother of Dora Marsden Atkinson, mother of Mary Atkinson Roocroft, mother
230. ANN (NANCY) HARWOOD<sup>245</sup>. Mother of Robert Marsden, father of Thomas Marsden, father of Mary Ellen Marsden, mother of Dora Marsden Atkinson, mother of Mary Atkinson Roocroft, mother
231. LUCY PENDLEBURY<sup>127</sup>. Wife of Thomas Marsden, son of Robert Marsden, brother of Mary Ellen Marsden, mother of Dora Marsden Atkinson, mother of Mary Atkinson Roocroft, mother
232. BERT WILKINSON<sup>125</sup>. Husband of Cissie Marsden, daughter of Robert Marsden, brother of Mary Ellen Marsden, mother of Dora Marsden Atkinson, mother of Mary Atkinson Roocroft, mother
233. JOHN THOMAS LOMAX<sup>130</sup>. Husband of Mary (Polly) Elizabeth Marsden, daughter of Richard (Dick) Marsden, brother of Mary Ellen Marsden, mother of Dora Marsden Atkinson, mother of Mary Atkinson Roocroft, mother
234. ALBERT LORD<sup>132</sup>. Husband of Elsie Marsden, daughter of Richard (Dick) Marsden, brother of Mary Ellen Marsden, mother of Dora Marsden Atkinson, mother of Mary Atkinson Roocroft, mother
235. STEPHEN BAILEY<sup>74</sup>. Husband of Carolyn Anne Harwood, daughter of Margaret Linda Wood, daughter of Linda Marsden Atkinson, sister of Dora Marsden Atkinson, mother of Mary Atkinson Roocroft, mother
236. IAN J BROWN<sup>76</sup>. Husband of Judith Harwood, daughter of Margaret Linda Wood, daughter of Linda Marsden Atkinson, sister of Dora Marsden Atkinson, mother of Mary Atkinson Roocroft, mother
237. CHRISTOPHER BROWN<sup>38</sup>. Son of Judith Harwood, daughter of Margaret Linda Wood, daughter of Linda Marsden Atkinson, sister of Dora Marsden Atkinson, mother of Mary Atkinson Roocroft, mother
238. MARTIN BROWN<sup>36</sup>. Son of Judith Harwood, daughter of Margaret Linda Wood, daughter of Linda Marsden Atkinson, sister of Dora Marsden Atkinson, mother of Mary Atkinson Roocroft, mother

**6 STEPS REMOVED**

239. JAMES JAMESON<sup>251</sup>. Father of Margaret Jameson, mother of Peter Jameson, father of William Jameson, father of John Jameson, father of Edward Corris Jameson, father of Robert Bryan Jameson, father
240. MARY WOODS<sup>252</sup>. Mother of Margaret Jameson, mother of Peter Jameson, father of William Jameson, father of John Jameson, father of Edward Corris Jameson, father of Robert Bryan Jameson, father
241. WILLIAM GASKELL<sup>215</sup>. Husband of Margaret Jameson, mother of Peter Jameson, father of William Jameson, father of John Jameson, father of Edward Corris Jameson, father of Robert Bryan Jameson, father
242. PATRICK CORRIS<sup>253</sup>. Father of William Corris, father of Simon Corris, father of Edward Corris, father of Mary Elizabeth Corris, mother of Edward Corris Jameson, father of Robert Bryan Jameson, father
243. CATHERINE CALLISTER<sup>254</sup>. Mother of William Corris, father of Simon Corris, father of Edward Corris, father of Mary Elizabeth Corris, mother of Edward Corris Jameson, father of Robert Bryan Jameson, father
244. WILLIAM COWLEY<sup>255</sup>. Father of Margaret Cowley, mother of Simon Corris, father of Edward Corris, father of Mary Elizabeth Corris, mother of Edward Corris Jameson, father of Robert Bryan Jameson, father
245. CATHERINE CUBBON<sup>256</sup>. Mother of Margaret Cowley, mother of Simon Corris, father of Edward Corris, father of Mary Elizabeth Corris, mother of Edward Corris Jameson, father of Robert Bryan Jameson, father
246. JAMES ROOCROFT<sup>257</sup>. Father of John Roocroft, father of Richard Roocroft, father of Edward Roocroft, father of Robert Roocroft, father of James Roocroft, father of Mary Atkinson Roocroft, mother
247. SARAH JOHNSON<sup>258</sup>. Mother of John Roocroft, father of Richard Roocroft, father of Edward Roocroft, father of Robert Roocroft, father of James Roocroft, father of Mary Atkinson Roocroft, mother
248. IRENE ELIZABETH MCDONALD BROCK<sup>98</sup>. Wife of David Ewart Roocroft, son of Eric Talbot Roocroft, son of William Roocroft, brother of Robert Roocroft, father of James Roocroft, father of Mary Atkinson Roocroft, mother
249. SIMON A ROOCROFT<sup>77</sup>. Son of David Ewart Roocroft, son of Eric Talbot Roocroft, son of William Roocroft, brother of Robert Roocroft, father of James Roocroft, father of Mary Atkinson Roocroft, mother
250. JOHN ATKINSON<sup>259</sup>. Father of William Atkinson, father of Christopher Atkinson, father of James Atkinson, father of John Atkinson, father of Dora Marsden Atkinson, mother of Mary Atkinson Roocroft, mother

**6 STEPS REMOVED (Continued)**

251. MARY WHITESIDE<sup>260</sup>. Mother of William Atkinson, father of Christopher Atkinson, father of James Atkinson, father of John Atkinson, father of Dora Marsden Atkinson, mother of Mary Atkinson Roocroft, mother
252. JOSHUA MARSDEN<sup>261</sup>. Father of Peter Marsden, father of Robert Marsden, father of Thomas Marsden, father of Mary Ellen Marsden, mother of Dora Marsden Atkinson, mother of Mary Atkinson Roocroft, mother
253. MARGARET LYPTROTT<sup>262</sup>. Mother of Peter Marsden, father of Robert Marsden, father of Thomas Marsden, father of Mary Ellen Marsden, mother of Dora Marsden Atkinson, mother of Mary Atkinson Roocroft, mother
254. GEORGE HARWOOD<sup>263</sup>. Father of Ann (Nancy) Harwood, mother of Robert Marsden, father of Thomas Marsden, father of Mary Ellen Marsden, mother of Dora Marsden Atkinson, mother of Mary Atkinson Roocroft, mother
255. ALICE TAYLOR<sup>264</sup>. Mother of Ann (Nancy) Harwood, mother of Robert Marsden, father of Thomas Marsden, father of Mary Ellen Marsden, mother of Dora Marsden Atkinson, mother of Mary Atkinson Roocroft, mother
256. JOHN HARWOOD<sup>248</sup>. Brother of Ann (Nancy) Harwood, mother of Robert Marsden, father of Thomas Marsden, father of Mary Ellen Marsden, mother of Dora Marsden Atkinson, mother of Mary Atkinson Roocroft, mother
257. ROBERT HARWOOD<sup>246</sup>. Brother of Ann (Nancy) Harwood, mother of Robert Marsden, father of Thomas Marsden, father of Mary Ellen Marsden, mother of Dora Marsden Atkinson, mother of Mary Atkinson Roocroft, mother
258. GEORGE HARWOOD<sup>247</sup>. Brother of Ann (Nancy) Harwood, mother of Robert Marsden, father of Thomas Marsden, father of Mary Ellen Marsden, mother of Dora Marsden Atkinson, mother of Mary Atkinson Roocroft, mother
259. JOHN HARWOOD<sup>250</sup>. Brother of Ann (Nancy) Harwood, mother of Robert Marsden, father of Thomas Marsden, father of Mary Ellen Marsden, mother of Dora Marsden Atkinson, mother of Mary Atkinson Roocroft, mother
260. ALICE HARWOOD<sup>249</sup>. Sister of Ann (Nancy) Harwood, mother of Robert Marsden, father of Thomas Marsden, father of Mary Ellen Marsden, mother of Dora Marsden Atkinson, mother of Mary Atkinson Roocroft, mother
261. MEGAN STOBBE<sup>39</sup>. Wife of Christopher Brown, son of Judith Harwood, daughter of Margaret Linda Wood, daughter of Linda Marsden Atkinson, sister of Dora Marsden Atkinson, mother of Mary Atkinson Roocroft, mother
262. XIMENG LUCY FAN<sup>37</sup>. Wife of Martin Brown, son of Judith Harwood, daughter of Margaret Linda Wood, daughter of Linda Marsden Atkinson, sister of Dora Marsden Atkinson, mother of Mary Atkinson Roocroft, mother

**7 STEPS REMOVED**

263. JAMES JAMESON<sup>265</sup>. Father of James Jameson, father of Margaret Jameson, mother of Peter Jameson, father of William Jameson, father of John Jameson, father of Edward Corris Jameson, father of Robert Bryan Jameson, father
264. MARGARET UNKNOWN<sup>266</sup>. Mother of James Jameson, father of Margaret Jameson, mother of Peter Jameson, father of William Jameson, father of John Jameson, father of Edward Corris Jameson, father of Robert Bryan Jameson, father
265. BEVERLEY J THORNLEY<sup>78</sup>. Wife of Simon A Roocroft, son of David Ewart Roocroft, son of Eric Talbot Roocroft, son of William Roocroft, brother of Robert Roocroft, father of James Roocroft, father of Mary Atkinson Roocroft, mother
266. TIMOTHY ATKINSON<sup>267</sup>. Father of John Atkinson, father of William Atkinson, father of Christopher Atkinson, father of James Atkinson, father of John Atkinson, father of Dora Marsden Atkinson, mother of Mary Atkinson Roocroft, mother
267. ELIZABETH HIGGINSON<sup>268</sup>. Mother of John Atkinson, father of William Atkinson, father of Christopher Atkinson, father of James Atkinson, father of John Atkinson, father of Dora Marsden Atkinson, mother of Mary Atkinson Roocroft, mother
268. PETER MARSDEN<sup>269</sup>. Father of Joshua Marsden, father of Peter Marsden, father of Robert Marsden, father of Thomas Marsden, father of Mary Ellen Marsden, mother of Dora Marsden Atkinson, mother of Mary Atkinson Roocroft, mother
269. ANNE ROBINSON<sup>270</sup>. Mother of Joshua Marsden, father of Peter Marsden, father of Robert Marsden, father of Thomas Marsden, father of Mary Ellen Marsden, mother of Dora Marsden Atkinson, mother of Mary Atkinson Roocroft, mother

**11. INDEX OF INDIVIDUALS**

<u>Ref.</u>	<u>Tree</u>	<u>Name (Relationship)</u>
266	74	UNKNOWN, Margaret (Andrew's six-times-great-grandmother <sup>264</sup> ).
166	50	ALLEN, Ann (Andrew's great-great-grandmother <sup>85</sup> ).
195	50	..... Robert (Andrew's great-great-great-grandfather <sup>150</sup> ).
27	6	ANDERSON, Paula Elizabeth (Andrew's cousin's wife, once removed <sup>159</sup> ).
162	57	ARROWSMITH, Elizabeth (Andrew's great-great-grandmother <sup>77</sup> ).
188	57	..... John (Andrew's great-great-great-grandfather <sup>143</sup> ).
205	51	ASHBURN, James (Andrew's great-great-great-grandfather <sup>172</sup> ).
172	51	..... Mary Ann (Andrew's great-great-grandmother <sup>118</sup> ).
202	61	ATKINSON, Catherine Charlotte (Andrew's great-great-great-grandmother <sup>167</sup> ).
207	76	..... Christopher (Andrew's great-great-great-grandfather <sup>174</sup> ).
102	52	..... Dora Marsden (Andrew's grandmother <sup>20</sup> ).
152	62	..... Edith (Andrew's great-great-aunt <sup>127</sup> ).
151	62	..... Elizabeth (Andrew's great-great-aunt <sup>126</sup> ).
149	62	..... Henry (Andrew's great-great-uncle <sup>124</sup> ).
150	62	..... Isabella (Andrew's great-great-aunt <sup>128</sup> ).
173	71	..... James (Andrew's great-great-grandfather <sup>122</sup> ).
259	76	..... John (Andrew's five-times-great-grandfather <sup>250</sup> ).
139	62	..... John (Andrew's great-grandfather <sup>69</sup> ).
234	61	..... John (Andrew's four-times-great-grandfather <sup>217</sup> ).
120	52	..... Linda Marsden (Andrew's great-aunt <sup>71</sup> ).
148	62	..... Mary (Andrew's great-great-aunt <sup>125</sup> ).
267	76	..... Timothy (Andrew's six-times-great-grandfather <sup>266</sup> ).
240	76	..... William (Andrew's four-times-great-grandfather <sup>225</sup> ).
74	24	BAILEY, Stephen (Andrew's second cousin's husband <sup>235</sup> ).
18	3	BAIRD-FRASER, Adam (Andrew's niece's husband <sup>75</sup> ).
225	59	BATTERAM, Ann (Andrew's four-times-great-grandmother <sup>205</sup> ).
203	61	BATTY, James Altham (Andrew's great-great-great-grandfather <sup>168</sup> ).
170	61	..... Mary (Andrew's great-great-grandmother <sup>115</sup> ).
236	61	..... Thomas (Andrew's four-times-great-grandfather <sup>219</sup> ).
227	60	BERRY, Elizabeth (Andrew's four-times-great-grandmother <sup>207</sup> ).
138	51	BEST, Elizabeth Evelyne (Andrew's great-grandmother <sup>63</sup> ).
171	51	..... Thomas Walsh (Andrew's great-great-grandfather <sup>117</sup> ).
96	33	BIBBY, Barbara E (Andrew's cousin's wife, once removed <sup>191</sup> ).
211	72	..... Mary (Andrew's great-great-great-grandmother <sup>179</sup> ).
177	73	BOLTON, Elizabeth (Betty) (Andrew's great-great-grandmother <sup>130</sup> ).
185	73	..... Hannah (Andrew's great-great-great-aunt <sup>182</sup> ).
212	73	..... John (Andrew's great-great-great-grandfather <sup>180</sup> ).
184	73	..... Sarah (Andrew's great-great-great-aunt <sup>183</sup> ).
63	22	BOOTH, Philip (Andrew's cousin's husband <sup>95</sup> ).
204	61	BRAYSHAW, Mary Ann (Andrew's great-great-grandmother <sup>169</sup> ).
238	61	..... William (Andrew's four-times-great-grandfather <sup>221</sup> ).
196	50	BRIGGS, Ann (Andrew's great-great-great-grandmother <sup>151</sup> ).
98	34	BROCK, Irene Elizabeth McDonald (Andrew's second cousin's wife, once removed <sup>248</sup> ).
38	25	BROWN, Christopher (Andrew's second cousin, once removed <sup>237</sup> ).
76	25	..... Ian J (Andrew's second cousin's husband <sup>236</sup> ).
36	25	..... Martin (Andrew's second cousin, once removed <sup>238</sup> ).
254	68	CALLISTER, Catherine (Andrew's five-times-great-grandmother <sup>243</sup> ).
16	13	CAMBLOR JAMESON, Linda (Andrew's niece <sup>31</sup> ).
14	13	..... Mateo (Andrew's nephew <sup>27</sup> ).
13	13	..... Nicholas (Andrew's nephew <sup>24</sup> ).
12	13	..... Roberto (Andrew's nephew <sup>28</sup> ).
15	13	..... Sofia (Andrew's niece <sup>30</sup> ).
45	13	CAMBLOR, César (Andrew's brother-in-law <sup>23</sup> ).
117	42	CAMPBELL, Herbert (Andrew's great-uncle by marriage <sup>119</sup> ).
219	58	CLAGUE, Elizabeth (Andrew's four-times-great-grandmother <sup>199</sup> ).
167	60	COBB, Amos (Andrew's great-great-grandfather <sup>88</sup> ).
136	60	..... Jane (Andrew's great-grandmother <sup>41</sup> ).
197	60	..... John (Andrew's great-great-great-grandfather <sup>152</sup> ).
226	60	..... William (Andrew's four-times-great-grandfather <sup>206</sup> ).
163	68	CORRIS, Edward (Andrew's great-great-grandfather <sup>81</sup> ).

<u>Ref.</u>	<u>Tree</u>	<u>Name (Relationship)</u>
134	58	CORRIS, Mary Elizabeth (Andrew's great-grandmother <sup>35</sup> ).
253	68	..... Patrick (Andrew's five-times-great-grandfather <sup>242</sup> ).
189	68	..... Simon (Andrew's great-great-great-grandfather <sup>144</sup> ).
216	68	..... William (Andrew's four-times-great-grandfather <sup>196</sup> ).
190	58	COWIN, Elizabeth (Andrew's great-great-great-grandmother <sup>145</sup> ).
218	58	..... Thomas (Andrew's four-times-great-grandfather <sup>198</sup> ).
217	68	COWLEY, Margaret (Andrew's four-times-great-grandmother <sup>197</sup> ).
255	68	..... William (Andrew's five-times-great-grandfather <sup>244</sup> ).
61	21	CRAWLEY, Anne J (Andrew's cousin's wife <sup>102</sup> ).
256	68	CUBBON, Catherine (Andrew's five-times-great-grandmother <sup>245</sup> ).
239	61	DOWNHAM, Alice (Andrew's four-times-great-grandmother <sup>222</sup> ).
10	11	EMERSON, Catherine Jane (Andrew's daughter <sup>10</sup> ).
43	11	..... Sally (Andrew's wife <sup>5</sup> ).
37	7	FAN, Ximeng Lucy (Andrew's second cousin's wife, once removed <sup>262</sup> ).
82	28	GARDINER, Sarah (Andrew's aunt by marriage <sup>45</sup> ).
215	74	GASKELL, William (Andrew's four-times-great-grandmother's husband <sup>241</sup> ).
90	31	HADDOCK, Joan (Andrew's aunt by marriage <sup>72</sup> ).
187	67	HADKIN, Frances (Fanny) (Andrew's great-great-great-grandmother <sup>140</sup> ).
164	58	HARRISON, Jane (Andrew's great-great-grandmother <sup>82</sup> ).
191	58	..... Richard (Andrew's great-great-great-grandfather <sup>146</sup> ).
249	78	HARWOOD, Alice (Andrew's four-times-great-great-aunt <sup>260</sup> ).
245	78	..... Ann (Nancy) (Andrew's four-times-great-grandmother <sup>230</sup> ).
73	32	..... Carolyn Anne (Andrew's second cousin <sup>194</sup> ).
247	78	..... George (Andrew's four-times-great-great-uncle <sup>258</sup> ).
263	78	..... George (Andrew's five-times-great-grandfather <sup>254</sup> ).
250	78	..... John (Andrew's four-times-great-great-uncle <sup>259</sup> ).
248	78	..... John (Andrew's four-times-great-great-uncle <sup>256</sup> ).
75	32	..... Judith (Andrew's second cousin <sup>193</sup> ).
94	32	..... Leslie James (Andrew's cousin's husband, once removed <sup>192</sup> ).
246	78	..... Robert (Andrew's four-times-great-great-uncle <sup>257</sup> ).
268	76	HIGGINSON, Elizabeth (Andrew's six-times-great-grandmother <sup>267</sup> ).
174	63	HODSON, Jane (Andrew's great-great-grandmother <sup>123</sup> ).
209	63	..... Sarah (Andrew's great-great-great-grandmother <sup>176</sup> ).
243	62	HUNTINGTON, Peggy (Margaret) (Andrew's four-times-great-grandmother <sup>228</sup> ).
60	29	JABLONSKI, Andrew P (Andrew's cousin <sup>58</sup> ).
58	29	..... Dennis C (Andrew's cousin <sup>59</sup> ).
54	29	..... Edwina M (Andrew's cousin <sup>60</sup> ).
85	29	..... Janik (Andrew's uncle by marriage <sup>56</sup> ).
56	29	..... Janina M A (Andrew's cousin <sup>61</sup> ).
52	29	..... John E (Andrew's cousin <sup>57</sup> ).
32	21	..... Pauline Anne (Andrew's cousin, once removed <sup>107</sup> ).
35	21	..... Robert Anthony (Andrew's cousin, once removed <sup>104</sup> ).
33	21	..... Simon Andrew (Andrew's cousin, once removed <sup>105</sup> ).
34	21	..... Timothy John (Andrew's cousin, once removed <sup>106</sup> ).
105	49	JAMESON, Amelia Ann (Andrew's great-aunt <sup>38</sup> ).
40	27	..... Andrew John (The subject of this report).
68	30	..... Angela Ruth (Andrew's cousin <sup>51</sup> ).
84	35	..... Brenda (Andrew's aunt <sup>18</sup> ).
87	35	..... Donald Templeman (Andrew's uncle <sup>16</sup> ).
99	49	..... Edward Corris (Andrew's grandfather <sup>12</sup> ).
83	35	..... Edward Dennis (Andrew's uncle <sup>13</sup> ).
67	30	..... Elizabeth H (Andrew's cousin <sup>54</sup> ).
141	57	..... Ellen (Andrew's great-great-aunt <sup>80</sup> ).
143	57	..... Fanny Elizabeth (Andrew's great-great-aunt <sup>79</sup> ).
70	30	..... Ian Robert (Andrew's cousin <sup>47</sup> ).
251	74	..... James (Andrew's five-times-great-grandfather <sup>239</sup> ).
265	74	..... James (Andrew's six-times-great-grandfather <sup>263</sup> ).
178	67	..... Jane (Andrew's great-great-great-aunt <sup>142</sup> ).
104	49	..... Jane Corris (Andrew's great-aunt <sup>39</sup> ).
66	30	..... Jean S (Andrew's cousin <sup>53</sup> ).

<u>Ref.</u>	<u>Tree</u>	<u>Name (Relationship)</u>
133	57	JAMESON, John (Andrew's great-grandfather <sup>34</sup> ).
107	49	..... John (Andrew's great-uncle <sup>37</sup> ).
81	35	..... John Corris (Andrew's uncle <sup>14</sup> ).
6	9	..... John Ross (Andrew's son <sup>9</sup> ).
86	35	..... Kathleen Nina (Andrew's aunt <sup>17</sup> ).
46	27	..... Kathryn Mary (Andrew's sister <sup>4</sup> ).
44	27	..... Linda Jane (Andrew's sister <sup>3</sup> ).
214	74	..... Margaret (Andrew's four-times-great-grandmother <sup>195</sup> ).
48	28	..... Margaret (Andrew's cousin <sup>52</sup> ).
142	57	..... Mary (Andrew's great-great-aunt <sup>78</sup> ).
179	67	..... Peter (Andrew's great-great-great-uncle <sup>141</sup> ).
186	75	..... Peter (Andrew's great-great-great-grandfather <sup>139</sup> ).
65	30	..... Peter M (Andrew's cousin <sup>48</sup> ).
64	30	..... Richard D (Andrew's cousin <sup>49</sup> ).
79	35	..... Robert Bryan (Andrew's father <sup>1</sup> ).
7	9	..... Robert Cameron (Andrew's son <sup>8</sup> ).
62	30	..... Sheila Anne (Andrew's cousin <sup>53</sup> ).
50	28	..... Susan D (Andrew's cousin <sup>50</sup> ).
161	67	..... William (Andrew's great-great-grandfather <sup>76</sup> ).
103	49	..... William Corris (Andrew's great-uncle <sup>36</sup> ).
258	70	JOHNSON, Sarah (Andrew's five-times-great-grandmother <sup>247</sup> ).
115	41	JONES, Charles Watkin (Andrew's great-uncle by marriage <sup>120</sup> ).
92	41	..... Muriel Irene (Andrew's cousin, once removed <sup>121</sup> ).
123	44	KING, Aileen Mary (Andrew's cousin's wife, twice removed <sup>223</sup> ).
200	60	LATTIMORE, Catherine (Andrew's great-great-great-grandmother <sup>155</sup> ).
230	60	..... Edward Green (Andrew's four-times-great-grandfather <sup>210</sup> ).
229	60	LEGGIN, Elizabeth (Andrew's four-times-great-grandmother <sup>209</sup> ).
175	63	LOFTHOUSE, Matthew (Andrew's step-great-great-grandfather <sup>177</sup> ).
130	47	LOMAX, John Thomas (Andrew's cousin's husband, twice removed <sup>233</sup> ).
132	48	LORD, Albert (Andrew's cousin's husband, twice removed <sup>234</sup> ).
262	77	LYPTROTT, Margaret (Andrew's five-times-great-grandmother <sup>253</sup> ).
11	2	MANU, Richard (Andrew's son-in-law <sup>33</sup> ).
124	55	MARSDEN, Cissie (Andrew's cousin, twice removed <sup>188</sup> ).
128	56	..... Edith (Andrew's cousin, twice removed <sup>187</sup> ).
131	56	..... Elsie (Andrew's cousin, twice removed <sup>189</sup> ).
154	64	..... James (Andrew's great-great-uncle <sup>135</sup> ).
157	64	..... John (Andrew's great-great-uncle <sup>134</sup> ).
261	77	..... Joshua (Andrew's five-times-great-grandfather <sup>252</sup> ).
129	56	..... Mary (Polly) Elizabeth (Andrew's cousin, twice removed <sup>190</sup> ).
140	64	..... Mary Ellen (Andrew's great-grandmother <sup>70</sup> ).
269	77	..... Peter (Andrew's six-times-great-grandfather <sup>268</sup> ).
244	77	..... Peter (Andrew's four-times-great-grandfather <sup>229</sup> ).
158	64	..... Richard (Dick) (Andrew's great-great-uncle <sup>131</sup> ).
155	64	..... Robert (Andrew's great-great-uncle <sup>133</sup> ).
210	77	..... Robert (Andrew's great-great-great-grandfather <sup>178</sup> ).
176	72	..... Thomas (Andrew's great-great-grandfather <sup>129</sup> ).
126	54	..... Thomas (Andrew's cousin, twice removed <sup>186</sup> ).
153	64	..... William Thomas (Andrew's great-great-uncle <sup>132</sup> ).
206	51	MCALPINE, Elizabeth (Andrew's great-great-great-grandmother <sup>173</sup> ).
31	19	MCLAREN, Amy (Andrew's cousin, once removed <sup>173</sup> ).
57	19	..... Neil (Andrew's cousin's husband <sup>108</sup> ).
30	19	..... Scott (Andrew's cousin, once removed <sup>111</sup> ).
221	58	MIDDLETON, Jane (Andrew's four-times-great-grandmother <sup>201</sup> ).
237	61	MOORE, Elizabeth (Andrew's four-times-great-grandmother <sup>220</sup> ).
213	73	MORRIS, Sarah (Andrew's great-great-great-grandmother <sup>181</sup> ).
231	60	NORRIS, Ann (Andrew's four-times-great-grandmother <sup>211</sup> ).
29	18	O'MARA, Craig Antony (Andrew's cousin, once removed <sup>110</sup> ).
28	18	..... Jason Andrew (Andrew's cousin, once removed <sup>112</sup> ).
55	18	..... Paul Thomas (Andrew's cousin's husband <sup>109</sup> ).
192	58	OXTON, Mary (Andrew's great-great-great-grandmother <sup>147</sup> ).

<u>Ref.</u>	<u>Tree</u>	<u>Name (Relationship)</u>
220	58	OXTON, Thomas (Andrew's four-times-great-grandfather <sup>200</sup> ).
198	60	PAYNE, Rebecca (Andrew's great-great-great-grandmother <sup>153</sup> ).
228	60	..... William Wm (Andrew's four-times-great-grandfather <sup>208</sup> ).
181	65	PEASGOOD, Mr. (Andrew's great-great-great-uncle by marriage <sup>214</sup> ).
127	46	PENDLEBURY, Lucy (Andrew's cousin's wife, twice removed <sup>231</sup> ).
183	66	POSNETTE, Sarah (Andrew's great-great-great-aunt by marriage <sup>212</sup> ).
69	23	POTTS, David A B (Andrew's cousin's husband <sup>93</sup> ).
235	61	PRICKETT, Katharine (Andrew's four-times-great-grandmother <sup>218</sup> ).
194	59	REEDMAN, Mary (Andrew's great-great-great-grandmother <sup>149</sup> ).
224	59	..... Robert (Andrew's four-times-great-grandfather <sup>204</sup> ).
233	70	RIGBY, Elizabeth (Andrew's four-times-great-grandmother <sup>216</sup> ).
270	77	ROBINSON, Anne (Andrew's six-times-great-grandmother <sup>269</sup> ).
114	51	ROOCROFT, Alice (Andrew's great-aunt <sup>67</sup> ).
72	31	..... Caroline (Andrew's cousin <sup>74</sup> ).
97	44	..... David Ewart (Andrew's second cousin, once removed <sup>224</sup> ).
71	31	..... David J (Andrew's cousin <sup>73</sup> ).
169	70	..... Edward (Andrew's great-great-grandfather <sup>114</sup> ).
119	51	..... Edward Walsh (Andrew's great-uncle <sup>66</sup> ).
122	53	..... Eric Talbot (Andrew's cousin, twice removed <sup>171</sup> ).
116	51	..... Ethel (Andrew's great-aunt <sup>68</sup> ).
257	70	..... James (Andrew's five-times-great-grandfather <sup>246</sup> ).
101	51	..... James (Andrew's grandfather <sup>19</sup> ).
232	70	..... John (Andrew's four-times-great-grandfather <sup>215</sup> ).
89	36	..... John Marsden (Andrew's uncle <sup>21</sup> ).
80	36	..... Mary Atkinson (Andrew's mother <sup>2</sup> ).
201	70	..... Richard (Andrew's great-great-great-grandfather <sup>166</sup> ).
137	61	..... Robert (Andrew's great-grandfather <sup>62</sup> ).
77	34	..... Simon A (Andrew's third cousin <sup>249</sup> ).
118	51	..... Thomas Harold (Andrew's great-uncle <sup>64</sup> ).
146	61	..... William (Andrew's great-great-uncle <sup>116</sup> ).
113	51	..... William (Andrew's great-uncle <sup>65</sup> ).
88	30	SANDERSON, Sheila (Andrew's aunt by marriage <sup>46</sup> ).
109	38	SARGEANT, Katherine (Andrew's great-aunt by marriage <sup>90</sup> ).
223	59	SCHWAB, Betty Mary (Andrew's four-times-great-grandmother <sup>203</sup> ).
106	37	SELLEN, George O A (Andrew's great-uncle by marriage <sup>83</sup> ).
9	1	SLACK, Michael Lee (Andrew's son-in-law <sup>32</sup> ).
59	20	SLATER, Laura E (Andrew's cousin's wife <sup>103</sup> ).
3	6	SOMERSALL, Mr. (Andrew's cousin, twice removed <sup>162</sup> ).
26	16	..... James Richard (Andrew's cousin, once removed <sup>100</sup> ).
51	16	..... Mel (Andrew's cousin's husband <sup>96</sup> ).
4	6	..... Nathan James (Andrew's cousin, twice removed <sup>163</sup> ).
5	6	..... Tristan Thomas (Andrew's cousin, twice removed <sup>161</sup> ).
180	69	STIMSON, Ann (Andrew's great-great-great-aunt <sup>157</sup> ).
168	69	..... Jane (Andrew's great-great-grandmother <sup>89</sup> ).
160	66	..... Jane Anne (Andrew's cousin, three times removed <sup>213</sup> ).
182	69	..... John (Andrew's great-great-great-uncle <sup>156</sup> ).
199	69	..... William (Andrew's great-great-great-grandfather <sup>154</sup> ).
39	8	STOBBE, Megan (Andrew's second cousin's wife, once removed <sup>261</sup> ).
22	4	STONE, Elizabeth J (Andrew's cousin's wife, once removed <sup>160</sup> ).
241	76	SUMMERS, Isabella (Andrew's four-times-great-grandmother <sup>226</sup> ).
147	53	TALBOT, Clara (Andrew's great-great-aunt by marriage <sup>170</sup> ).
264	78	TAYLOR, Alice (Andrew's five-times-great-grandmother <sup>235</sup> ).
108	50	TEMPLEMAN, Amos Stimson (Andrew's great-uncle <sup>42</sup> ).
91	40	..... Audrey (Andrew's cousin, once removed <sup>92</sup> ).
112	50	..... Edith (Andrew's great-aunt <sup>44</sup> ).
100	50	..... Emma (Andrew's grandmother <sup>13</sup> ).
145	59	..... Henry (Andrew's great-great-uncle <sup>87</sup> ).
110	50	..... Louisa (Kate) Catherine (Andrew's great-aunt <sup>43</sup> ).
193	59	..... Robert (Andrew's great-great-great-grandfather <sup>148</sup> ).
135	59	..... Thomas (Andrew's great-grandfather <sup>40</sup> ).

<u>Ref.</u>	<u>Tree</u>	<u>Name (Relationship)</u>
165	59	TEMPLEMAN, William (Andrew's great-great-grandfather <sup>84</sup> ).
144	59	..... William (Andrew's great-great-uncle <sup>86</sup> ).
222	59	..... William Roy (Andrew's four-times-great-grandfather <sup>202</sup> ).
25	5	THORNES, Jacqueline A (Andrew's cousin's wife, once removed <sup>158</sup> ).
78	26	THORNLEY, Beverley J (Andrew's third cousin's wife <sup>265</sup> ).
20	14	VICKERS, Benjamin James (Andrew's nephew <sup>26</sup> ).
17	14	..... Linda Charlotte (Andrew's niece <sup>29</sup> ).
19	14	..... Thomas William (Andrew's nephew <sup>25</sup> ).
47	14	..... William Leslie (Andrew's brother-in-law <sup>22</sup> ).
111	39	WAKEFIELD, Albert George (Andrew's great-uncle by marriage <sup>91</sup> ).
2	5	WARDLE, Ms. (Andrew's cousin, twice removed <sup>164</sup> ).
1	5	..... Ms. (Andrew's cousin, twice removed <sup>165</sup> ).
23	15	..... Edward Jonathan (Andrew's cousin, once removed <sup>99</sup> ).
21	15	..... Robin Marcus (Andrew's cousin, once removed <sup>98</sup> ).
49	15	..... Roy (Andrew's cousin's husband <sup>94</sup> ).
24	15	..... Timothy James (Andrew's cousin, once removed <sup>97</sup> ).
53	17	WARMINGTON, Catherine R (Andrew's cousin's wife <sup>101</sup> ).
8	12	WATTS, Rachel Jane (Andrew's daughter <sup>11</sup> ).
41	9	WHITEHURST, Judith Anne (Andrew's wife <sup>7</sup> ).
260	76	WHITESIDE, Mary (Andrew's five-times-great-grandmother <sup>251</sup> ).
125	45	WILKINSON, Bert (Andrew's cousin's husband, twice removed <sup>232</sup> ).
156	54	..... Martha (Andrew's great-great-aunt by marriage <sup>185</sup> ).
121	43	WOOD, Ernest Croft (Andrew's great-uncle by marriage <sup>136</sup> ).
95	43	..... John Derek (Andrew's cousin, once removed <sup>137</sup> ).
93	43	..... Margaret Linda (Andrew's cousin, once removed <sup>138</sup> ).
42	10	WOODS, Jane Elizabeth (Andrew's wife <sup>6</sup> ).
252	74	..... Mary (Andrew's five-times-great-grandmother <sup>240</sup> ).
159	56	WOODWARD, Amy Ann (Andrew's great-great-aunt by marriage <sup>184</sup> ).
208	62	WRIGHT, Mary (Andrew's great-great-great-grandmother <sup>175</sup> ).
242	62	..... Thomas (Andrew's four-times-great-grandfather <sup>227</sup> ).



**A Genealogy Report For**

**JUDITH ANNE WHITEHURST**



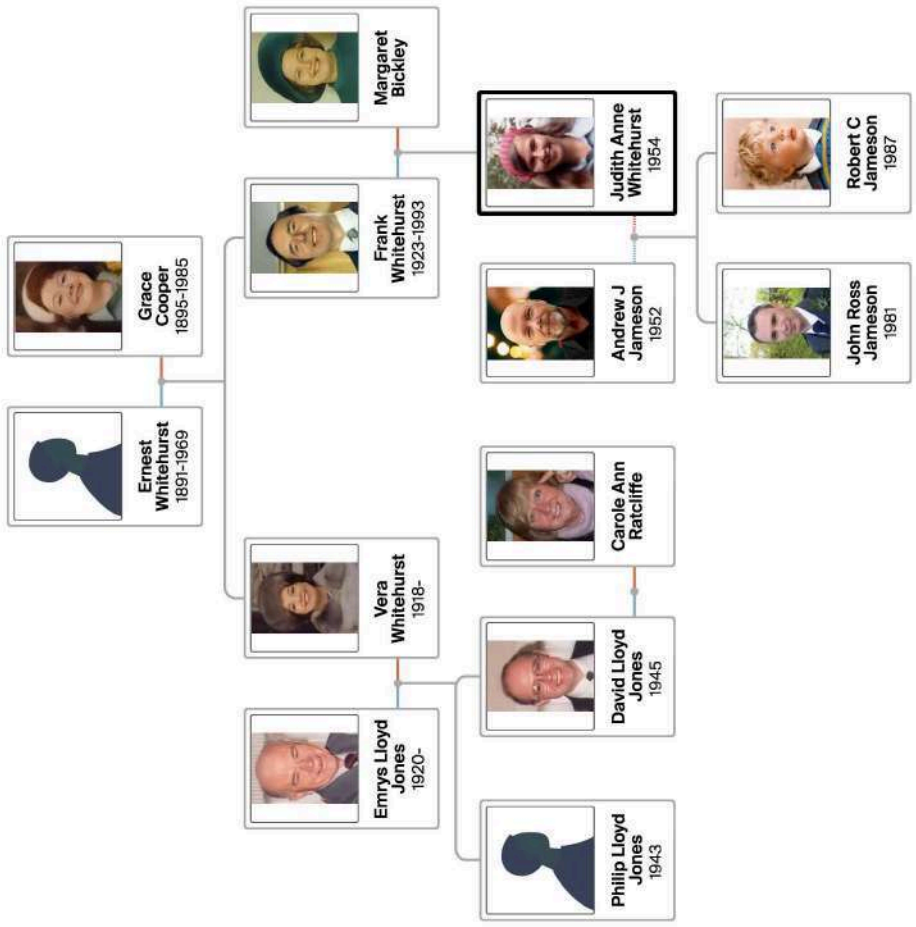



**CONTENTS**

- 1. INTRODUCTION**
- 2. PATERNAL ANCESTRY**
- 3. MATERNAL ANCESTRY**
- 4. DESCENDANTS**
- 5. DIRECT RELATIONS**
- 6. FAMILY TREES**
- 7. INDEX OF PLACES**
- 8. INDEX OF DATES**
- 9. INDEX OF ANNIVERSARIES**
- 10. RELATIONSHIP PATHS**
- 11. INDEX OF INDIVIDUALS**



## **1. INTRODUCTION**

### **STATISTICS**

This document reports the details of 13 individuals, of which 8 are male and 5 are female. Of the 3 individuals with recorded birth and death dates, the average lifespan was 79 years. Of these, 2 males averaged 73.5 years, and 1 females averaged 90 years.

The longest living male was Ernest Whitehurst<sup>12</sup>, who died aged 77. The longest living female was Grace Cooper<sup>13</sup>, who died aged 90.

There are 7 families reported. 6 of these families are reported as having children, with an average of 1.5 children per family.

### **THE NARRATIVE SECTIONS**

The "Direct Relations" section reports the details of individuals who have a direct family connection to Judith Anne Whitehurst<sup>3</sup>. The section is broken into sub-sections for each generation, within which the individuals are listed in order of closeness of relationship. The sequence numbers are used throughout the document to cross-reference back to the detailed entry of an individual.

With a narrative section, each generation is shown as a separate subsection, within which the individuals are listed in order of the closeness of their relationship to Judith Anne Whitehurst<sup>3</sup>.

### **FAMILY TREES SECTION**

Each family tree shows the reported children, parents, grandparents and great-grandparents of a family group. In order to reduce redundancy, any family group which is wholly included within another family tree may not be reported separately.

Above each of the great-grandparent boxes (top row), a continuation family tree reference number is shown if the great-grandparent is recorded as a child in the continuation tree. A continuation reference number is also shown to the left of a grandparent or parent box if that individual has siblings reported in the continuation tree; and beneath a child box (bottom row) if that individual has children reported in the continuation tree.

In cases of multiple marriages, a continuation reference number preceded by "=" is shown to the right of a parent box. This number references the previous and/or next tree in which that individual is shown with another partner.

**2. PATERNAL ANCESTRY**

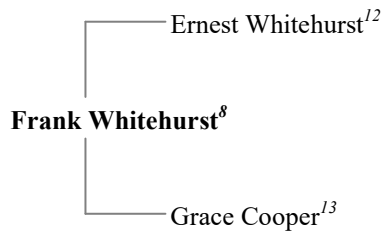

**3. MATERNAL ANCESTRY**

**Margaret Bickley<sup>9</sup>**

**4. DESCENDANTS**

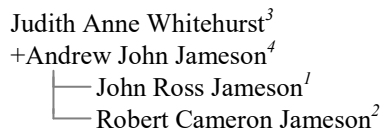

## 5. DIRECT RELATIONS

### Generation of Children

1. JOHN ROSS JAMESON (Judith's son<sup>4</sup>, see Descendants) was born on 16 May 1981, in Raigmore, Inverness, to Andrew John Jameson<sup>4</sup> and Judith Anne Whitehurst<sup>3</sup>, as shown in family tree 1. In 2007, aged about 26, he resided in Andover, Hampshire, England, United Kingdom. In 2013, aged about 32, he resided in Andover, Hampshire, England.



2. ROBERT CAMERON JAMESON (Judith's son<sup>5</sup>, see Descendants) was born on 10 August 1987, in Winchester, Hampshire, to Andrew John Jameson<sup>4</sup> and Judith Anne Whitehurst<sup>3</sup>, as shown in family tree 1.



### Generation of Peers

3. JUDITH ANNE WHITEHURST (The subject of this report) was born in May 1954, in Stoke, Staffordshire, to Frank Whitehurst<sup>8</sup> and Margaret Bickley<sup>9</sup>, as shown within family tree 1. In 1985, aged about 31, she resided in Andover, Hampshire, England.



4. ANDREW JOHN JAMESON (Judith's husband<sup>3</sup>) was born on 5 April 1952, in Havercroft, Bolton, Lancashire, England, to Robert Bryan Jameson and Mary Atkinson Roorcroft. In September 1975, aged 23, he resided in Stornoway, Scotland. In January 1977, aged 24, he resided in Black Isle, Scotland. In September 1985, aged 33, he resided in Appleshaw, Hampshire, England. In January 1991, aged 38, Andrew resided in Dean Village, Edinburgh. In June 1995, aged 43, he resided in North Berwick, East Lothian, Scotland. In September 1999, aged 47, he resided in Chorlton cum Hardy, Lancashire, England. In August 2003, aged 51, Andrew resided in Astley village, Chorley, Lancashire, England. In 2014, aged about 62, he resided in Pechón, Spain. On 21 October 2021, aged 69, he resided in Alyth, Perthshire, Scotland.



The following information is also recorded for Andrew. Address in 2009, aged about 57, in Pechón, Spain. Andrew married three times. He was married to Sally Emerson, Judith Anne Whitehurst<sup>3</sup> and Jane Elizabeth Woods.

Andrew John Jameson married Sally Emerson. They had one daughter:

Catherine Jane Emerson in 1992

The following information is also recorded for this family. Separation in 1995, when Andrew was aged 43 and Sally was aged 41.

*This family is shown as family tree 1.*

Andrew John Jameson, aged 25, married Judith Anne Whitehurst<sup>3</sup>, aged 23, in December 1977 in Bolton, Greater Manchester, United Kingdom, and they were divorced in 1989, when aged 37 and 35 respectively.

They had two sons:

John Ross Jameson<sup>1</sup> in 1981

Robert Cameron Jameson<sup>2</sup> in 1987

*This family is shown as family tree 1.*

Andrew John Jameson, aged 66, married Jane Elizabeth Woods, aged 60, on 19 May 2018 in Contin, Ross-shire, Scotland. They had one daughter:

Rachel Jane Watts in 1990

*This family is shown as family tree 1.*

5. PHILIP LLOYD JONES (Judith's cousin<sup>11</sup>) was born in July 1943, in Stoke, Staffordshire, to Emrys Lloyd Jones<sup>11</sup> and Vera Whitehurst<sup>10</sup>, as shown in family tree 3. He is no longer living.

6. DAVID LLOYD JONES (Judith's cousin<sup>10</sup>) was born in October 1945, in Stoke, Staffordshire, to Emrys Lloyd Jones<sup>11</sup> and Vera Whitehurst<sup>10</sup>, as shown in family tree 3.



7. CAROLE ANN RATCLIFFE (Judith's cousin's wife<sup>12</sup>).



David Lloyd Jones<sup>6</sup>, aged about 23, married Carole Ann Ratcliffe in 1969 in Trentham, Staffordshire, England. See family tree 2.

### Generation of Parents

8. FRANK WHITEHURST (Judith's father<sup>1</sup>, see Paternal Ancestry) was born on 8 July 1923 to Ernest Whitehurst<sup>12</sup> and Grace Cooper<sup>13</sup>, as shown in family tree 4. In 1939, aged about 15, he resided in Staffordshire, England (Marital Status: Single; Occupation: Student). He died on 4 January 1993, aged 69, in Ladybridge Bolton.



The following information is also recorded for Frank. Probate: on 27 January 1993, in Manchester.

9. MARGARET BICKLEY (Judith's mother<sup>2</sup>, see Maternal Ancestry). She is no longer living.



Frank Whitehurst<sup>8</sup>, aged 24, married Margaret Bickley in April 1948 in Stoke, Staffordshire, United Kingdom. They had one daughter:

Judith Anne Whitehurst<sup>3</sup> in 1954

This family is shown within family tree 1.

10. VERA WHITEHURST (Judith's aunt<sup>8</sup>) was born in 1918, in Burslem, Staffordshire, England, to Ernest Whitehurst<sup>12</sup> and Grace Cooper<sup>13</sup>, as shown in family tree 4. In 1921, aged about 3, she resided in Burslem, Staffordshire, England (Relation to Head of House: Daughter). She is no longer living.



11. EMRYS LLOYD JONES (Judith's uncle by marriage<sup>9</sup>) was born in January 1920, in Newcastle L, Staffordshire. He is no longer living.



Emrys Lloyd Jones, aged 21, married Vera Whitehurst<sup>10</sup>, aged about 23, in July 1941 in Stoke, Staffordshire, United Kingdom. They had two sons:

Philip Lloyd Jones<sup>5</sup> in 1943

David Lloyd Jones<sup>6</sup> in 1945

This family is shown as family tree 3.

### Generation of Grandparents

12. ERNEST WHITEHURST (Judith's grandfather<sup>6</sup>, see Paternal Ancestry) was born on 24 July 1891, in Wolstanton, Staffordshire, England. In 1921, aged about 29, he resided in Burslem, Staffordshire, England (Occupation: Ironworks Stocktaker; Marital Status: Married; Relation to Head of House: Head). In 1939, aged about 47, he resided in Staffordshire, England (Marital Status: Married; Occupation: Sanitary Wark Pottery Worker). He died in 1969, aged about 77, in Stoke on Trent, Staffordshire, England.

13. GRACE COOPER (Judith's grandmother<sup>7</sup>, see Paternal Ancestry) was born on 5 January 1895, in Hanley Staffs United Kingdom. In 1921, aged about 26, she resided in Burslem, Staffordshire, England (Occupation: Home Duties; Marital Status: Married; Relation to Head of House: Wife). In 1939, aged about 44, she resided in Staffordshire, England (Marital Status: Married; Occupation: Unpaid Domestic Duties). She died on 14 August 1985, aged 90, in Stoke on Trent, Staffordshire, England.



Ernest Whitehurst<sup>12</sup>, aged about 25, married Grace Cooper, aged about 22, in 1917 in Stoke upon Trent, Staffordshire, England. They had two children:

Vera Whitehurst<sup>10</sup> in 1918

Frank Whitehurst<sup>8</sup> in 1923

*This family is shown as family tree 4.*

## **6. FAMILY TREES**

1. JAMESON, Andrew John and WHITEHURST, Judith Anne
2. JONES, David Lloyd and RATCLIFFE, Carole Ann
3. JONES, Emrys Lloyd and WHITEHURST, Vera
4. WHITEHURST, Ernest and COOPER, Grace

**1. Andrew John Jameson and Judith Anne Whitehurst**

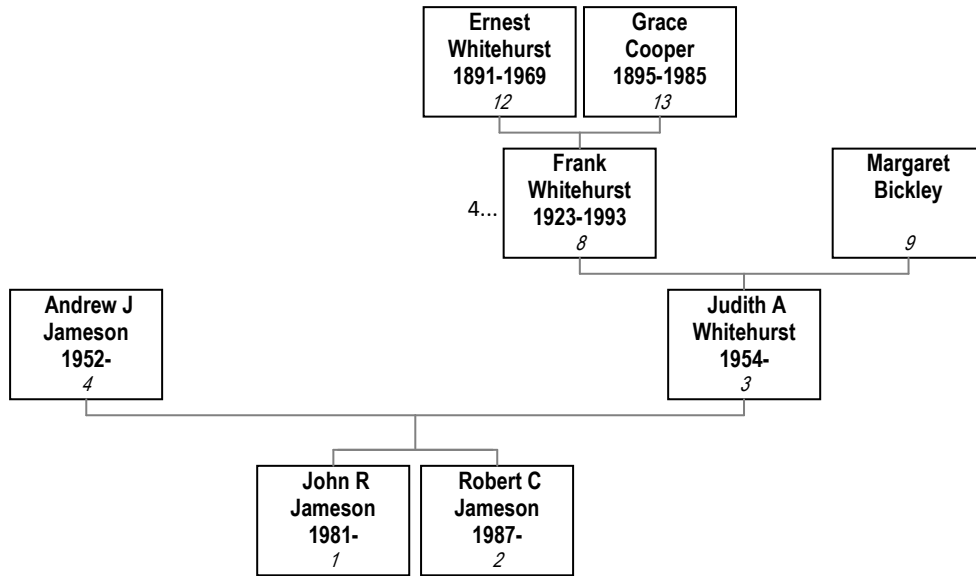

**2. David Lloyd Jones and Carole Ann Ratcliffe**

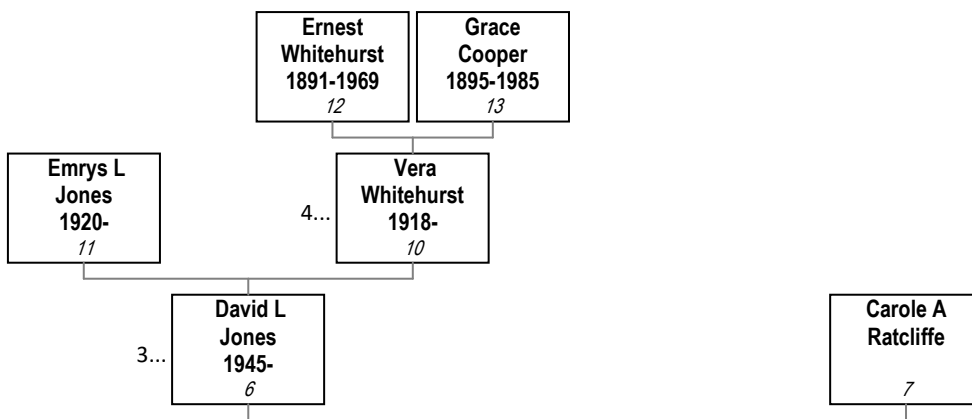

**3. Emrys Lloyd Jones and Vera Whitehurst**

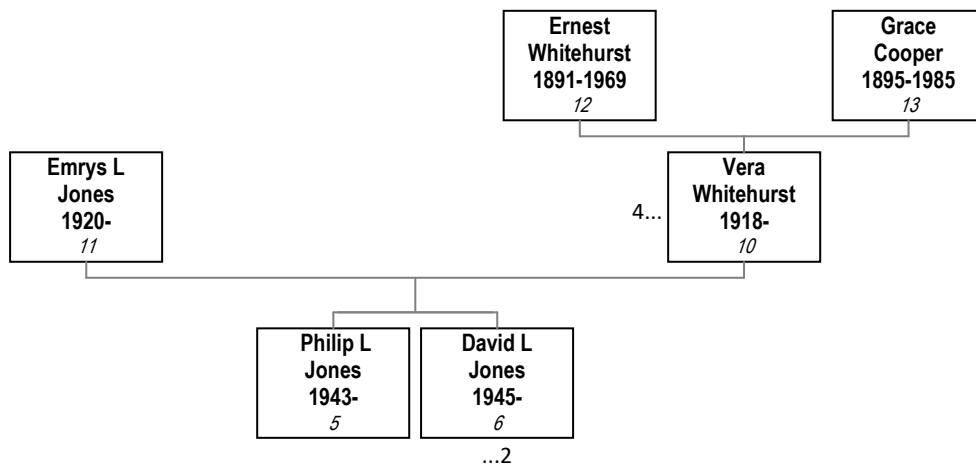

**4. Ernest Whitehurst and Grace Cooper**

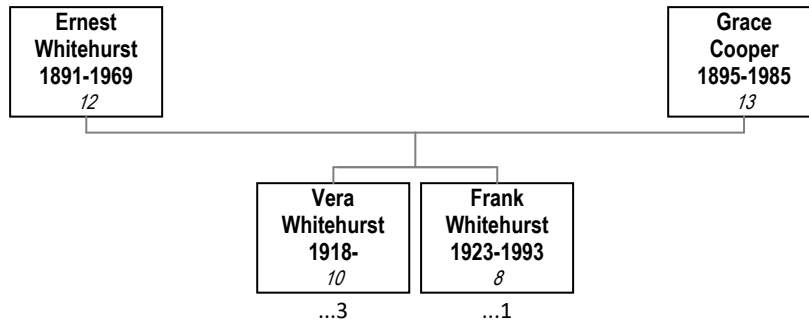

**7. INDEX OF PLACES**

**EDINBURGH, DEAN VILLAGE**

Residence of Andrew John Jameson<sup>4</sup> in January 1991.

**ENGLAND, HAMPSHIRE, ANDOVER**

Residence of Judith Anne Whitehurst<sup>3</sup> in 1985.

Residence of John Ross Jameson<sup>1</sup> in 2013.

**ENGLAND, HAMPSHIRE, APPLESRAW**

Residence of Andrew John Jameson<sup>4</sup> in September 1985.

**ENGLAND, LANCASHIRE, BOLTON, HAVERCROFT**

Birth of Andrew John Jameson<sup>4</sup> on 5 April 1952.

**ENGLAND, LANCASHIRE, CHORLEY, ASTLEY VILLAGE**

Residence of Andrew John Jameson<sup>4</sup> in August 2003.

**ENGLAND, LANCASHIRE, CHORLTON CUM HARDY**

Residence of Andrew John Jameson<sup>4</sup> in September 1999.

**ENGLAND, STAFFORDSHIRE**

Residence of Grace Cooper<sup>13</sup> in 1939.

Residence of Frank Whitehurst<sup>8</sup> in 1939.

Residence of Ernest Whitehurst<sup>12</sup> in 1939.

**ENGLAND, STAFFORDSHIRE, BURSLEM**

Birth of Vera Whitehurst<sup>10</sup> in 1918.

Residence of Vera Whitehurst<sup>10</sup> in 1921.

Residence of Grace Cooper<sup>13</sup> in 1921.

Residence of Ernest Whitehurst<sup>12</sup> in 1921.

**ENGLAND, STAFFORDSHIRE, STOKE ON TRENT**

Death of Ernest Whitehurst<sup>12</sup> in 1969.

Death of Grace Cooper<sup>13</sup> on 14 August 1985.

**ENGLAND, STAFFORDSHIRE, STOKE UPON TRENT**

Marriage of Ernest Whitehurst<sup>12</sup> and Grace Cooper<sup>13</sup> in 1917.

**ENGLAND, STAFFORDSHIRE, TRENTHAM**

Marriage of David Lloyd Jones<sup>6</sup> and Carole Ann Ratcliffe<sup>7</sup> in 1969.

**ENGLAND, STAFFORDSHIRE, WOLSTANTON**

Birth of Ernest Whitehurst<sup>12</sup> on 24 July 1891.

**HAMPSHIRE, WINCHESTER**

Birth of Robert Cameron Jameson<sup>2</sup> on 10 August 1987.

**HANLEY STAFFS UNITED KINGDOM**

Birth of Grace Cooper<sup>13</sup> on 5 January 1895.

**INVERNESS, RAIGMORE**

Birth of John Ross Jameson<sup>1</sup> on 16 May 1981.

**LADYBRIDGE BOLTON**

Death of Frank Whitehurst<sup>8</sup> on 4 January 1993.

**MANCHESTER**

Probate: Frank Whitehurst<sup>8</sup> on 27 January 1993.

**SCOTLAND, BLACK ISLE**

Residence of Andrew John Jameson<sup>4</sup> in January 1977.

**SCOTLAND, EAST LOTHIAN, NORTH BERWICK**

Residence of Andrew John Jameson<sup>4</sup> in June 1995.

**SCOTLAND, PERTHSHIRE, ALYTH**

Residence of Andrew John Jameson<sup>4</sup> on 21 October 2021.

**SCOTLAND, ROSS-SHIRE, CONTIN**

Marriage of Andrew John Jameson<sup>4</sup> and Jane Elizabeth Woods on 19 May 2018.

**SCOTLAND, STORNOWAY**

Residence of Andrew John Jameson<sup>4</sup> in September 1975.

**SPAIN, PECHÓN**

Address: Andrew John Jameson<sup>4</sup> in 2009.

Residence of Andrew John Jameson<sup>4</sup> in 2014.

**STAFFORDSHIRE, NEWCASTLE L**

Birth of Emrys Lloyd Jones<sup>11</sup> in January 1920.

**STAFFORDSHIRE, STOKE**

Birth of Philip Lloyd Jones<sup>5</sup> in July 1943.

Birth of David Lloyd Jones<sup>6</sup> in October 1945.

Birth of Judith Anne Whitehurst<sup>3</sup> in May 1954.

**UNITED KINGDOM, ENGLAND, HAMPSHIRE, ANDOVER**

Residence of John Ross Jameson<sup>1</sup> in 2007.

**UNITED KINGDOM, GREATER MANCHESTER, BOLTON**

Marriage of Andrew John Jameson<sup>4</sup> and Judith Anne Whitehurst<sup>3</sup> in December 1977.

**UNITED KINGDOM, STAFFORDSHIRE, STOKE**

Marriage of Emrys Lloyd Jones<sup>11</sup> and Vera Whitehurst<sup>10</sup> in July 1941.

Marriage of Frank Whitehurst<sup>8</sup> and Margaret Bickley<sup>9</sup> in April 1948.

**8. INDEX OF DATES**

- 1891**  
Birth of Ernest Whitehurst<sup>12</sup> on 24 July, in Wolstanton, Staffordshire, England.
- 1895**  
Birth of Grace Cooper<sup>13</sup> on 5 January, in Hanley Staffs United Kingdom.
- 1917**  
Marriage of Ernest Whitehurst<sup>12</sup> and Grace Cooper<sup>13</sup> in Stoke upon Trent, Staffordshire, England.
- 1918**  
Birth of Vera Whitehurst<sup>10</sup> in Burslem, Staffordshire, England.
- 1920**  
Birth of Emrys Lloyd Jones<sup>11</sup> in January, in Newcastle L, Staffordshire.
- 1921**  
Residence of Ernest Whitehurst<sup>12</sup> in Burslem, Staffordshire, England.  
Residence of Vera Whitehurst<sup>10</sup> in Burslem, Staffordshire, England.  
Residence of Grace Cooper<sup>13</sup> in Burslem, Staffordshire, England.
- 1923**  
Birth of Frank Whitehurst<sup>8</sup> on 8 July.
- 1939**  
Residence of Frank Whitehurst<sup>8</sup> in Staffordshire, England.  
Residence of Grace Cooper<sup>13</sup> in Staffordshire, England.  
Residence of Ernest Whitehurst<sup>12</sup> in Staffordshire, England.
- 1941**  
Marriage of Emrys Lloyd Jones<sup>11</sup> and Vera Whitehurst<sup>10</sup> in July, in Stoke, Staffordshire, United Kingdom.
- 1943**  
Birth of Philip Lloyd Jones<sup>5</sup> in July, in Stoke, Staffordshire.
- 1945**  
Birth of David Lloyd Jones<sup>6</sup> in October, in Stoke, Staffordshire.
- 1948**  
Marriage of Frank Whitehurst<sup>8</sup> and Margaret Bickley<sup>9</sup> in April, in Stoke, Staffordshire, United Kingdom.
- 1952**  
Birth of Andrew John Jameson<sup>4</sup> on 5 April, in Havercroft, Bolton, Lancashire, England.
- 1954**  
Birth of Judith Anne Whitehurst<sup>3</sup> in May, in Stoke, Staffordshire.
- 1969**  
Marriage of David Lloyd Jones<sup>6</sup> and Carole Ann Ratcliffe<sup>7</sup> in Trentham, Staffordshire, England.  
Death of Ernest Whitehurst<sup>12</sup> in Stoke on Trent, Staffordshire, England.
- 1975**  
Residence of Andrew John Jameson<sup>4</sup> in September, in Stornoway, Scotland.
- 1977**  
Residence of Andrew John Jameson<sup>4</sup> in January, in Black Isle, Scotland.  
Marriage of Andrew John Jameson<sup>4</sup> and Judith Anne Whitehurst<sup>3</sup> in December, in Bolton, Greater Manchester, United Kingdom.
- 1981**  
Birth of John Ross Jameson<sup>1</sup> on 16 May, in Raigmore, Inverness.
- 1985**  
Residence of Judith Anne Whitehurst<sup>3</sup> in Andover, Hampshire, England.  
Death of Grace Cooper<sup>13</sup> on 14 August, in Stoke on Trent, Staffordshire, England.  
Residence of Andrew John Jameson<sup>4</sup> in September, in Appleshaw, Hampshire, England.
- 1987**  
Birth of Robert Cameron Jameson<sup>2</sup> on 10 August, in Winchester, Hampshire.
- 1989**  
Divorce of Andrew John Jameson<sup>4</sup> and Judith Anne Whitehurst<sup>3</sup>.
- 1991**  
Residence of Andrew John Jameson<sup>4</sup> in January, in Dean Village, Edinburgh.
- 1993**  
Death of Frank Whitehurst<sup>8</sup> on 4 January, in Ladybridge Bolton.  
Probate: Frank Whitehurst<sup>8</sup> on 27 January, in Manchester.
- 1995**  
Residence of Andrew John Jameson<sup>4</sup> in June, in North Berwick, East Lothian, Scotland.  
Separation: Andrew John Jameson<sup>4</sup> and Sally Emerson.
- 1999**  
Residence of Andrew John Jameson<sup>4</sup> in September, in Chorlton cum Hardy, Lancashire, England.
- 2003**  
Residence of Andrew John Jameson<sup>4</sup> in August, in Astley village, Chorley, Lancashire, England.
- 2007**  
Residence of John Ross Jameson<sup>1</sup> in Andover, Hampshire, England, United Kingdom.

**2009**

Address: Andrew John Jameson<sup>f</sup> in Pechón, Spain.

**2013**

Residence of John Ross Jameson<sup>f</sup> in Andover, Hampshire, England.

**2014**

Residence of Andrew John Jameson<sup>f</sup> in Pechón, Spain.

**2018**

Marriage of Andrew John Jameson<sup>f</sup> and Jane Elizabeth Woods on 19 May, in Contin, Ross-shire, Scotland.

**2021**

Residence of Andrew John Jameson<sup>f</sup> on 21 October, in Alyth, Perthshire, Scotland.

## 9. INDEX OF ANNIVERSARIES

### **JANUARY**

- 4. Death of Frank Whitehurst<sup>8</sup> in Ladybridge Bolton, in 1993
- 5. Birth of Grace Cooper<sup>13</sup> in Hanley Staffs United Kingdom, in 1895
- 27. Probate: Frank Whitehurst<sup>8</sup> in Manchester, in 1993
- Birth of Emrys Lloyd Jones<sup>11</sup> in Newcastle L, Staffordshire, in 1920
- Residence of Andrew John Jameson<sup>4</sup> in Black Isle, Scotland, in 1977
- Residence of Andrew John Jameson<sup>4</sup> in Dean Village, Edinburgh, in 1991

### **APRIL**

- 5. Birth of Andrew John Jameson<sup>4</sup> in Havercroft, Bolton, Lancashire, England, in 1952
- Marriage of Frank Whitehurst<sup>8</sup> and Margaret Bickley<sup>9</sup> in Stoke, Staffordshire, United Kingdom, in 1948

### **MAY**

- 16. Birth of John Ross Jameson<sup>1</sup> in Raigmore, Inverness, in 1981
- 19. Marriage of Andrew John Jameson<sup>4</sup> and Jane Elizabeth Woods in Contin, Ross-shire, Scotland, in 2018
- Birth of Judith Anne Whitehurst<sup>3</sup> in Stoke, Staffordshire, in 1954

### **JUNE**

- Residence of Andrew John Jameson<sup>4</sup> in North Berwick, East Lothian, Scotland, in 1995

### **JULY**

- 8. Birth of Frank Whitehurst<sup>8</sup>, in 1923
- 24. Birth of Ernest Whitehurst<sup>12</sup> in Wolstanton, Staffordshire, England, in 1891
- Marriage of Emrys Lloyd Jones<sup>11</sup> and Vera Whitehurst<sup>10</sup> in Stoke, Staffordshire, United Kingdom, in 1941
- Birth of Philip Lloyd Jones<sup>5</sup> in Stoke, Staffordshire, in 1943

### **AUGUST**

- 10. Birth of Robert Cameron Jameson<sup>2</sup> in Winchester, Hampshire, in 1987
- 14. Death of Grace Cooper<sup>13</sup> in Stoke on Trent, Staffordshire, England, in 1985
- Residence of Andrew John Jameson<sup>4</sup> in Astley village, Chorley, Lancashire, England, in 2003

### **SEPTEMBER**

- Residence of Andrew John Jameson<sup>4</sup> in Stornoway, Scotland, in 1975
- Residence of Andrew John Jameson<sup>4</sup> in Appleshaw, Hampshire, England, in 1985
- Residence of Andrew John Jameson<sup>4</sup> in Chorlton cum Hardy, Lancashire, England, in 1999

### **OCTOBER**

- 21. Residence of Andrew John Jameson<sup>4</sup> in Alyth, Perthshire, Scotland, in 2021
- Birth of David Lloyd Jones<sup>6</sup> in Stoke, Staffordshire, in 1945

### **DECEMBER**

- Marriage of Andrew John Jameson<sup>4</sup> and Judith Anne Whitehurst<sup>3</sup> in Bolton, Greater Manchester, United Kingdom, in 1977

## 10. RELATIONSHIP PATHS

This section details the relationship of each connected individual to Judith Anne Whitehurst.

To facilitate cross-referencing, the relationship reference number in this section is shown with the relationship description within the other sections.

### **IMMEDIATE FAMILY**

1. FRANK WHITEHURST<sup>8</sup>. Father.
2. MARGARET BICKLEY<sup>9</sup>. Mother.
3. ANDREW JOHN JAMESON<sup>4</sup>. Husband.
4. JOHN ROSS JAMESON<sup>1</sup>. Son.
5. ROBERT CAMERON JAMESON<sup>2</sup>. Son.

### **1 STEP REMOVED**

6. ERNEST WHITEHURST<sup>12</sup>. Father's father.
7. GRACE COOPER<sup>13</sup>. Father's mother.
8. VERA WHITEHURST<sup>10</sup>. Father's sister.

### **2 STEPS REMOVED**

9. EMRYS LLOYD JONES<sup>11</sup>. Father's sister's husband.
10. DAVID LLOYD JONES<sup>6</sup>. Father's sister's son.
11. PHILIP LLOYD JONES<sup>5</sup>. Father's sister's son.

### **3 STEPS REMOVED**

12. CAROLE ANN RATCLIFFE<sup>7</sup>. Father's sister's son's wife.

## 11. INDEX OF INDIVIDUALS

<u>Ref.</u>	<u>Tree</u>	<u>Name (Relationship)</u>
9	1	BICKLEY, Margaret (Judith's mother <sup>2</sup> ).
13	4	COOPER, Grace (Judith's grandmother <sup>7</sup> ).
4	1	JAMESON, Andrew John (Judith's husband <sup>3</sup> ).
1	1	..... John Ross (Judith's son <sup>4</sup> ).
2	1	..... Robert Cameron (Judith's son <sup>5</sup> ).
6	3	JONES, David Lloyd (Judith's cousin <sup>10</sup> ).
11	3	..... Emrys Lloyd (Judith's uncle by marriage <sup>9</sup> ).
5	3	..... Philip Lloyd (Judith's cousin <sup>11</sup> ).
7	2	RATCLIFFE, Carole Ann (Judith's cousin's wife <sup>12</sup> ).
12	4	WHITEHURST, Ernest (Judith's grandfather <sup>6</sup> ).
8	4	..... Frank (Judith's father <sup>1</sup> ).
3	1	..... Judith Anne (The subject of this report).
10	4	..... Vera (Judith's aunt <sup>8</sup> ).

## **For Jane – A Light That Still Shines**

She walked among us, bright and true,  
A guiding light, a golden hue.  
With laughter soft and kindness deep,  
She sowed a love that still will keep.

Though time was brief, her touch was vast,  
Her echoes woven through the past.  
A beacon strong, she lit the way,  
And in our hearts, she'll always stay.

The roots she traced, the tales she found,  
Are living echoes all around.  
A legacy of love and grace,  
That time nor distance can erase.

So here within these pages bright,  
Her family's past comes into sight.  
But know, though stories fade and part,  
She lives within each beating heart.

For love outlives the fleeting years,  
And hope still gleams through loss and tears.  
So turn the page and find her near—  
Her light still shines; she's always here.



# **Branches of Our Tree**

**ANDREW JOHN JAMESON**

**AND**

**JANE ELIZABETH JAMESON**



**"The Complete Genealogy Reporter"**  
© 2006-2025 Nigel Bufton Software







**A Genealogy Report For**

**JANE ELIZABETH WOODS**





William Stott, Esq. only Son, Married, Maria, youngest Daughter  
of Rev. John Stott of Wexham, Berkshire, his first Cousin  
& has 10 Children being Jan<sup>y</sup> 1839



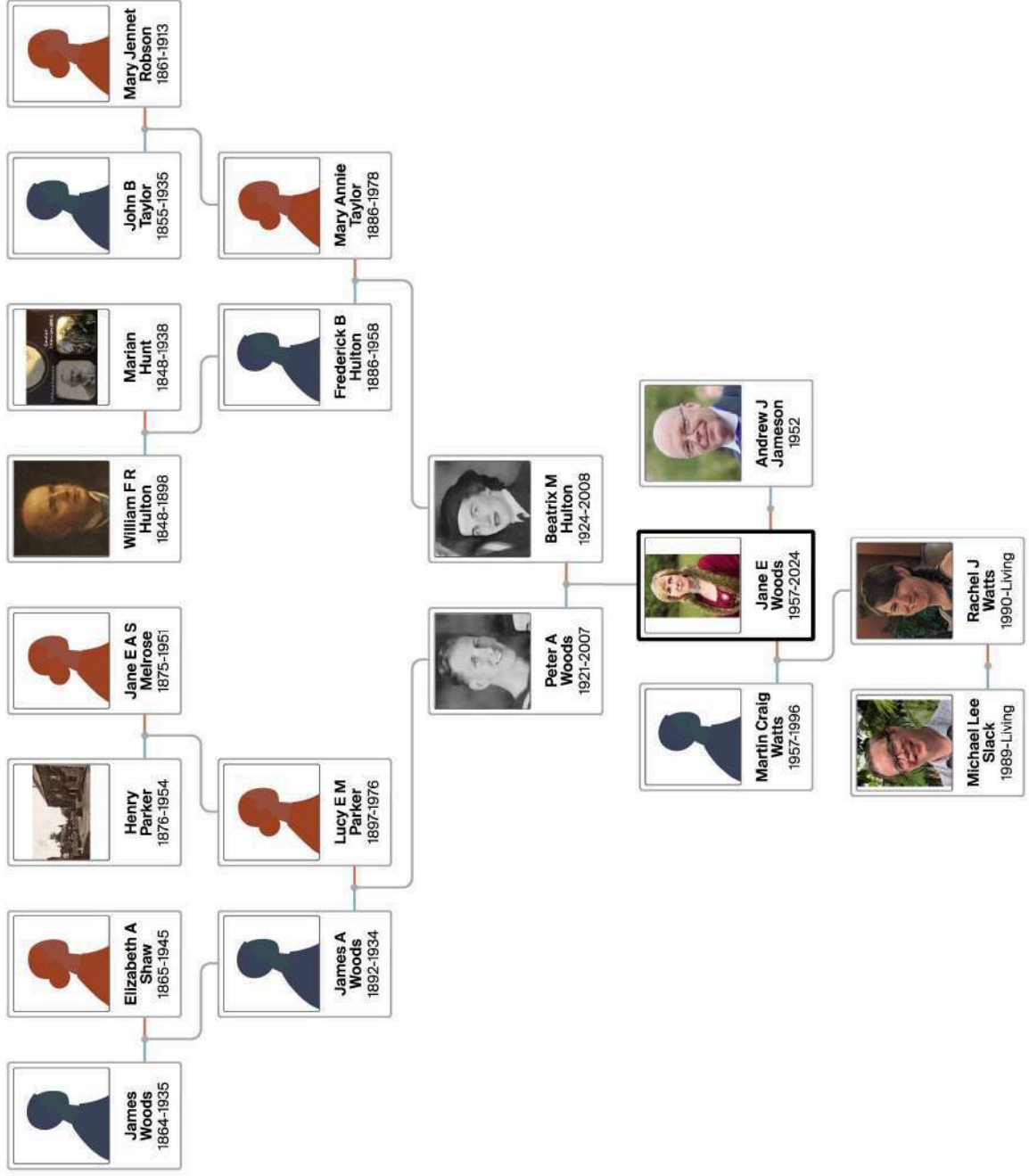



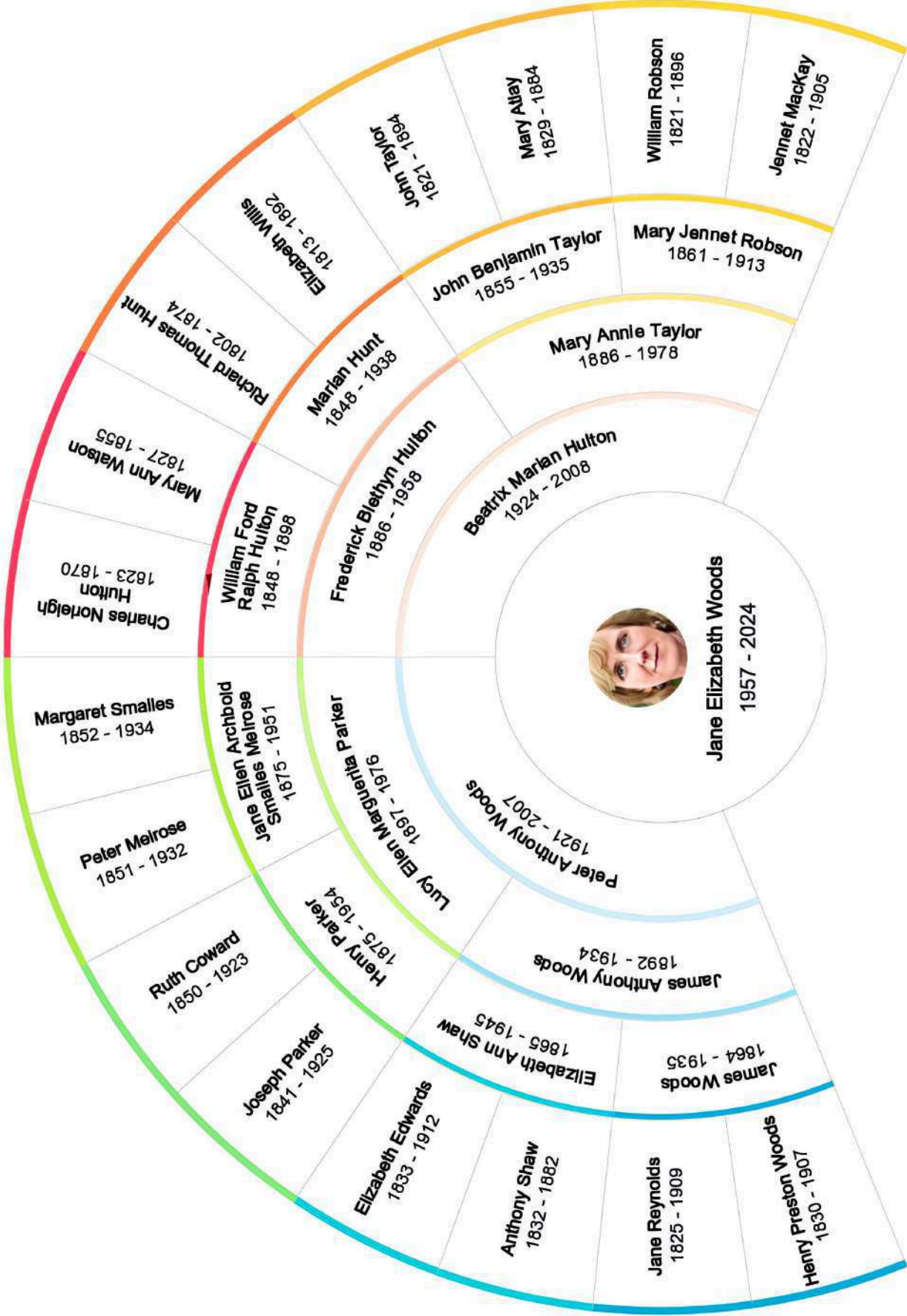

**Jane Elizabeth Woods**  
1957 - 2024

**Beatrice Marian Hulston**  
1924 - 2008

**Peter Anthony Woods**  
1921 - 2007

**Mary Annie Taylor**  
1886 - 1978

**John Benjamin Taylor**  
1855 - 1935

**Mary Jennet Robson**  
1861 - 1913

**Mary Atlay**  
1829 - 1884

**William Robson**  
1821 - 1896

**Jennet MackKay**  
1822 - 1905

**John Taylor**  
1821 - 1894

**Elizabeth Mills**  
1813 - 1892

**Richard Thomas Hunt**  
1802 - 1874

**Marian Hunt**  
1848 - 1938

**Mary Ann Watson**  
1827 - 1855

**William Ford  
Ralph Hulston**  
1848 - 1898

**Frederick Blethyn Hulston**  
1886 - 1958

**Charles Norleigh  
Hulston**  
1823 - 1870

**Jane Ellen Archbold  
Smalles Melrose**  
1875 - 1951

**Lucy Ellen Marguerite Parker**  
1897 - 1976

**Margaret Smalles**  
1852 - 1934

**Peter Melrose**  
1851 - 1932

**James Anthony Woods**  
1892 - 1934

**Ruth Coward**  
1850 - 1923

**Henry Parker**  
1875 - 1934

**Elizabeth Ann Shaw**  
1865 - 1945

**James Woods**  
1864 - 1935

**Joseph Parker**  
1841 - 1925

**Elizabeth Edwards**  
1833 - 1912

**Anthony Shaw**  
1832 - 1882

**Jane Reynolds**  
1825 - 1909

**Henry Preston Woods**  
1830 - 1907



**CONTENTS**

- 1. INTRODUCTION**
- 2. PATERNAL ANCESTRY**
- 3. MATERNAL ANCESTRY**
- 4. DESCENDANTS**
- 5. DIRECT RELATIONS**
- 6. FAMILY TREES**
- 7. INDEX OF PLACES**
- 8. INDEX OF DATES**
- 9. INDEX OF ANNIVERSARIES**
- 10. RELATIONSHIP PATHS**
- 11. INDEX OF INDIVIDUALS**



## **1. INTRODUCTION**

### **STATISTICS**

This document reports the details of 170 individuals, of which 88 are male and 82 are female. Of the 77 individuals with recorded birth and death dates, the average lifespan was 63.7 years. Of these, 45 males averaged 56.1 years, and 32 females averaged 74.3 years.

The longest living male was David De Hulton<sup>164</sup>, who died aged 91. The longest living female was Margaret (Meg) Hulton<sup>77</sup>, who died aged 99.

There are 80 families reported. 61 of these families are reported as having children, with an average of 1.6 children per family.

### **THE NARRATIVE SECTIONS**

The "Direct Relations" section reports the details of individuals who have a direct family connection to Jane Elizabeth Woods<sup>26</sup>. The section is broken into sub-sections for each generation, within which the individuals are listed in order of closeness of relationship. The sequence numbers are used throughout the document to cross-reference back to the detailed entry of an individual.

With a narrative section, each generation is shown as a separate subsection, within which the individuals are listed in order of the closeness of their relationship to Jane Elizabeth Woods<sup>26</sup>.

### **FAMILY TREES SECTION**

Each family tree shows the reported children, parents, grandparents and great-grandparents of a family group. In order to reduce redundancy, any family group which is wholly included within another family tree may not be reported separately.

Above each of the great-grandparent boxes (top row), a continuation family tree reference number is shown if the great-grandparent is recorded as a child in the continuation tree. A continuation reference number is also shown to the left of a grandparent or parent box if that individual has siblings reported in the continuation tree; and beneath a child box (bottom row) if that individual has children reported in the continuation tree.

In cases of multiple marriages, a continuation reference number preceded by "=" is shown to the right of a parent box. This number references the previous and/or next tree in which that individual is shown with another partner.

**2. PATERNAL ANCESTRY**

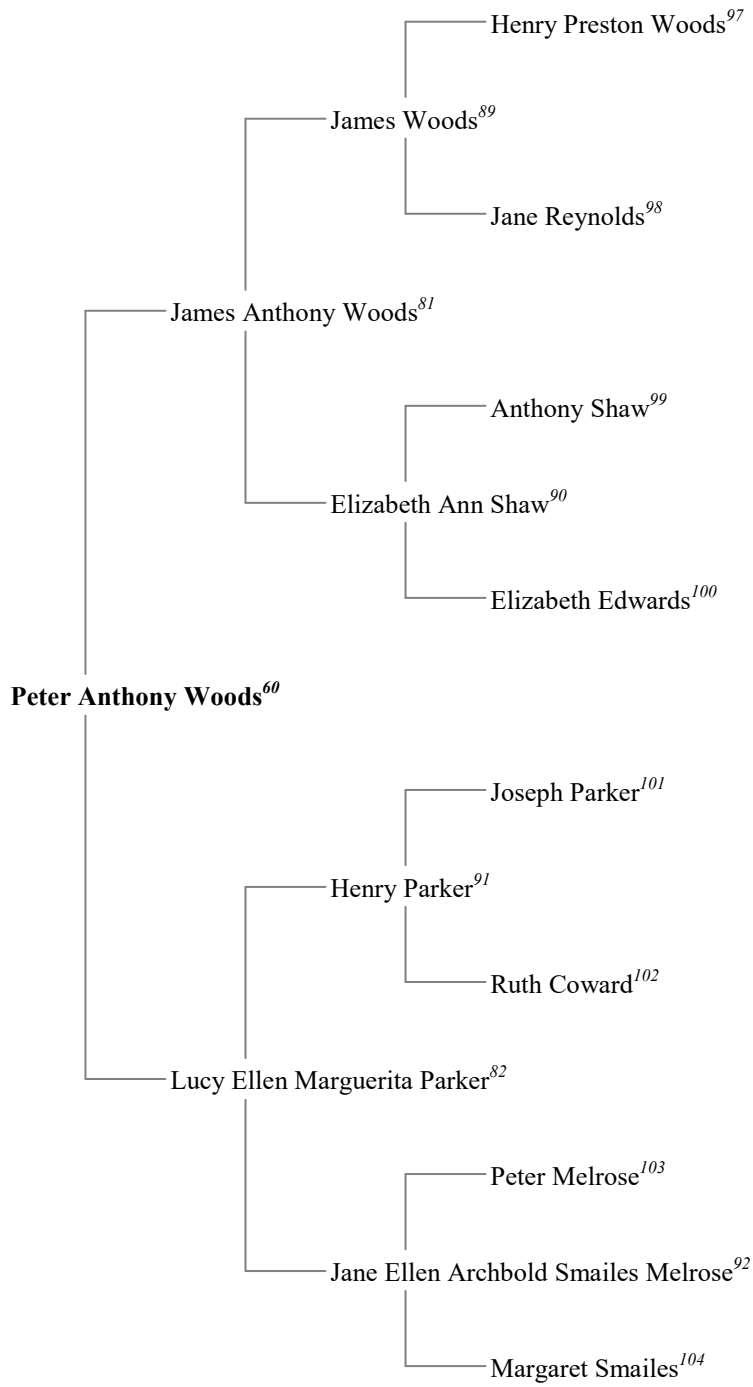

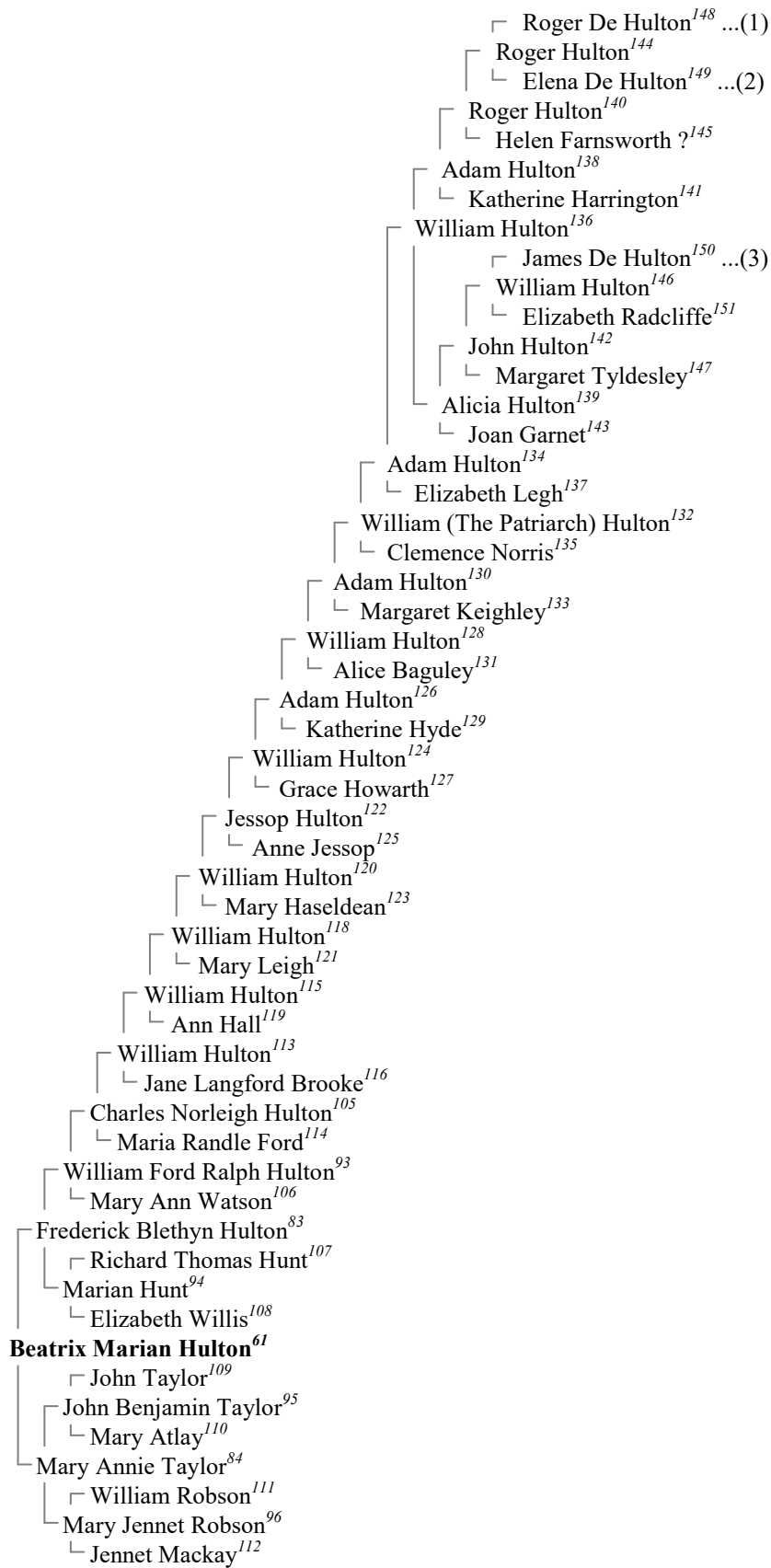
**3. MATERNAL ANCESTRY**

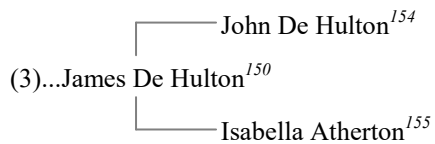
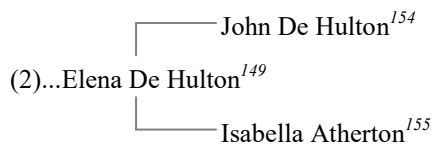
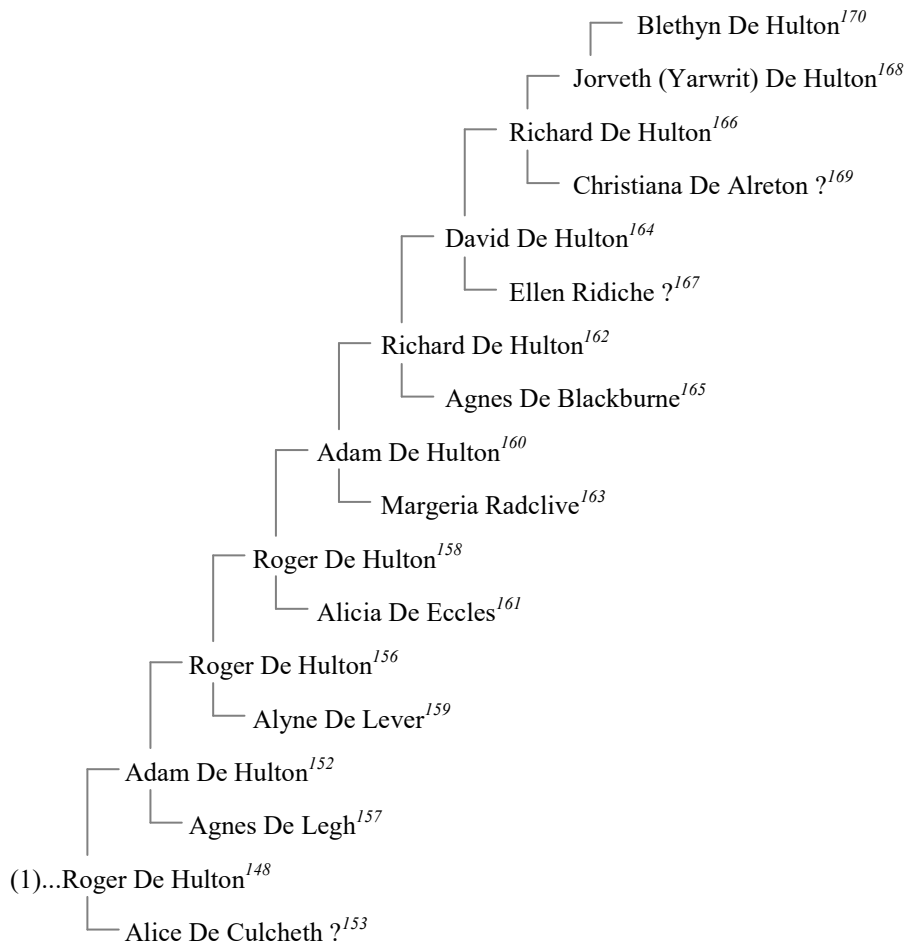

Jane Elizabeth Woods<sup>26</sup>+Martin Craig Watts<sup>27</sup>└─ Rachel Jane Watts<sup>2</sup>

This family possesses the most unerring proof of antiquity in the title-deeds of their estate of Hulton, from which the Hultons derive their surname, and of which they have been uninterrupted lords since the Conquest. The first feudal proprietor on record,

**BLEYTHIN DE HULTON**, living temp. **HENRY II.** was father of

**JORVETH**, *alias* **YARWIT DE HULTON**, who flourished in the reigns of **RICHARD I.** and **JOHN**, and obtained from the latter a grant by charter of the town of Penelton, in Lancashire, in exchange for other lands which the king, when Earl of Morton, had given him. He had, with other issue, a son,

**RICHARD DE HULTON**, who had a grant of lands in Barton, from Edith de Barton, by consent of Gilbert de Notton, her husband, which lands Jorveth de Hulton, father of Richard, had some time held of her. To his son and successor,

**DAVID DE HULTON**, Lord of Hulton, his cousin, Robert de Hulton, granted all his lands in Hulton, and William de Ferrers

### Lineage.

gave all his possessions in Flixton, together with his manor of Hordeshale, by homage and service of two marks of silver four times a year, and by the sixth part of a knight's fee, A. D. 1219. David de Hulton wedded Agnes, daughter of Adam de Blackburne, and was father of several sons,\* of whom the eldest,

**RICHARD DE HULTON**, of Hulton, living temp. **EDWARD I.** had a charter of a free warren in his demesne lands of Hulton, Ordshall, Flixton, and Heaton, in the 32nd of that reign. He *m.* Margery, daughter of Robert de Radclive, of Radclive Tower, and had issue,

I. **RICHARD**, his heir.

II. **John**, of Halliwell, living 35 **EDWARD III.**

III. **ADAM**, successor to his nephew.

IV. **Roger**, who held lands in Manchester, and *d.* prior to the 14th of **EDWARD III.**

The eldest son,

**RICHARD DE HULTON**, of Hulton Park, had a grant of lands in Halghton, from the abbot and convent of Cockersand, dated 16th June, 5th **EDWARD II.** This Richard left a son and successor,

**RICHARD DE HULTON**, of Hulton Park, who *d. s. p.* and was *s.* in his estates (of which he had made a settlement, 7th **EDWARD III.**) by his uncle,

**ADAM DE HULTON**, of Hulton Park, living temp. **EDWARD III.** who *m.* Alicia de Eccles, and had, with several younger sons, his successor,

**ROGER DE HULTON**, of Hulton Park, who

\* From John de Hulton, the youngest son, descended the Hultons of Farnsworth.

## 5. DIRECT RELATIONS

### Generation of Grandchildren

1. CONNOR WOODS (Jane's great-nephew<sup>66</sup>) was born in February 2005 to Alastair Richard Woods<sup>6</sup> and Kirsten Unknown<sup>7</sup>, as shown in family tree 3.

### Generation of Children

2. RACHEL JANE WATTS (Jane's daughter<sup>7</sup>, see Descendants) was born on 24 March 1990 to Martin Craig Watts<sup>27</sup> and Jane Elizabeth Woods<sup>26</sup>, as shown in family tree 7. '2008–2010' she resided in Chorley, Lancashire, England, United Kingdom.



3. MICHAEL LEE SLACK (Jane's son-in-law<sup>26</sup>) was born on 3 March 1989, in Sutton In Ashfield, Nottinghamshire, England. '2007–2008' he resided in Telford, Shropshire, England, United Kingdom. Michael Lee Slack married Rachel Jane Watts<sup>2</sup>. See family tree 1.



4. JENNIFER CLARE WOODS (Jane's niece<sup>25</sup>) was born in January 1968, in Preston, Lancashire, to Richard George Woods<sup>29</sup> and Margaret Mackenzie<sup>30</sup>, as shown in family tree 9. '1996–2020' she resided in Durham, North Carolina, USA.



5. DAVID ROWSON (Jane's niece's husband<sup>67</sup>).  
David Rowson married Jennifer Clare Woods<sup>4</sup>, aged 54, in January 2022 in Durham County, North Carolina, USA. See family tree 2.

6. ALASTAIR RICHARD WOODS (Jane's nephew<sup>24</sup>) was born in January 1969, in Amounderness, Lancashire, to Richard George Woods<sup>29</sup> and Margaret Mackenzie<sup>30</sup>, as shown in family tree 9. '2003–2008' he resided in Mitcham, Surrey, England, United Kingdom. In 2012, aged about 43, he resided in Mitcham, Surrey, England.



7. KIRSTEN UNKNOWN (Jane's nephew's wife<sup>65</sup>).  
Alastair Richard Woods<sup>6</sup> married Kirsten Unknown. They had one son:  
Connor Woods<sup>1</sup> in 2005  
*This family is shown as family tree 3.*

8. SIMON ANDREW WOODS (Jane's nephew<sup>23</sup>) was born in April 1970 to Richard George Woods<sup>29</sup> and Margaret Mackenzie<sup>30</sup>, as shown in family tree 9.



9. DAWN WILSON (Jane's nephew's wife<sup>64</sup>).  
Simon Andrew Woods<sup>8</sup> married Dawn Wilson. See family tree 4.



10. MICHAEL A LOGUE (Jane's cousin, once removed<sup>89</sup>) was born in July 1965, in Lancaster, Lancashire, to Thomas B Logue<sup>34</sup> and Rosemary Hopkins<sup>33</sup>, as shown in family tree 10.

11. HELEN JOSEPHINE LOGUE (Jane's cousin, once removed<sup>91</sup>) was born in April 1967, in Lancaster, Lancashire, to Thomas B Logue<sup>34</sup> and Rosemary Hopkins<sup>33</sup>, as shown in family tree 10.

12. CATHERINE ALICE LOGUE (Jane's cousin, once removed<sup>92</sup>) was born in April 1968, in Lancaster, Lancashire, to Thomas B Logue<sup>34</sup> and Rosemary Hopkins<sup>33</sup>, as shown in family tree 10.
13. ROBERT TAYLOR (Jane's cousin, once removed<sup>82</sup>) was born in July 1988, in Lancaster, Lancashire, to David Taylor<sup>35</sup> and Veronica Ann Cairns<sup>36</sup>, as shown in family tree 11.
14. LAURA UNKNOWN (Jane's cousin's wife, once removed<sup>110</sup>).  
Robert Taylor<sup>13</sup> married Laura Unknown. See family tree 5.
15. JENNIFER TAYLOR (Jane's cousin, once removed<sup>83</sup>) was born in April 1992, in Lancaster, Lancashire, to David Taylor<sup>35</sup> and Veronica Ann Cairns<sup>36</sup>, as shown in family tree 11.
16. CHRIS HESLOP (Jane's cousin's husband, once removed<sup>111</sup>) was born on 7 August 1968.  
Chris Heslop, aged 47, married Jennifer Taylor<sup>15</sup>, aged 23, on 15 August 2015. See family tree 6.
17. JAMES WILLIAM TAYLOR (Jane's cousin, once removed<sup>81</sup>) was born on 5 September 1988 to John A Taylor<sup>37</sup> and Margaret M Swarbrick<sup>38</sup>, as shown in family tree 12. '2006–2010' he resided in Lancaster, Lancashire, England, United Kingdom.
18. LYNNE MARGARET TAYLOR (Jane's cousin, once removed<sup>84</sup>) was born in February 1991, in Lancaster, Lancashire, to John A Taylor<sup>37</sup> and Margaret M Swarbrick<sup>38</sup>, as shown in family tree 12.
19. GEORGINA AUDREY LISTER (Jane's cousin, once removed<sup>90</sup>) was born in August 1992, in Lancaster, Lancashire, to Raymond Lister<sup>40</sup> and Gail Saunders<sup>39</sup>, as shown in family tree 13.
20. CALLUM SEAN MCDONALD (Jane's cousin, once removed<sup>78</sup>) was born in September 1997, in Stockport, Cheshire, to Sean P McDonald<sup>49</sup> and Amanda Helen Woods<sup>48</sup>, as shown in family tree 16.
21. CONNOR ALAN MCDONALD (Jane's cousin, once removed<sup>77</sup>) was born in September 1997, in Stockport, Cheshire, to Sean P McDonald<sup>49</sup> and Amanda Helen Woods<sup>48</sup>, as shown in family tree 16.
22. CORRIE HULTON (Jane's cousin, once removed<sup>102</sup>) was born to Mr. Hulton<sup>50</sup> and Judy Sopher<sup>51</sup>, as shown in family tree 17.
23. TRACY HULTON (Jane's cousin, once removed<sup>103</sup>) was born to Mr. Hulton<sup>50</sup> and Judy Sopher<sup>51</sup>, as shown in family tree 17.
24. DANA ANDERSON (Jane's cousin, once removed<sup>105</sup>) was born to Jack Anderson<sup>54</sup> and Patricia Hulton<sup>53</sup>, as shown in family tree 18.
25. SEAN ANDERSON (Jane's cousin, once removed<sup>106</sup>) was born on 29 December 1977 to Jack Anderson<sup>54</sup> and Patricia Hulton<sup>53</sup>, as shown in family tree 18.

### Generation of Peers

26. JANE ELIZABETH WOODS (The subject of this report) was born on 25 May 1957, in Preston, Lancashire, England, to Peter Anthony Woods<sup>60</sup> and Beatrix Marian Hulton<sup>61</sup>, as shown in family tree 22. '2004–2010' she resided in Chorley, Lancashire, England, United Kingdom. She died on 27 September 2024, aged 67, in Alyth, Perthshire, Scotland.  

 Jane married three times; including Martin Craig Watts<sup>27</sup> and Andrew John Jameson<sup>28</sup>.  
 Jane Elizabeth Woods was married on 19 May 2018 in Contin, Ross-shire, Scotland.
27. MARTIN CRAIG WATTS (Jane's husband<sup>6</sup>) was born on 4 April 1957. He died on 26 August 1996, aged 39, in Preston and South Ribble, Lancashire, England. He was buried on 6 September 1996 in Cambridgeshire, England.  
 Martin Craig Watts, aged 22, married Jane Elizabeth Woods<sup>26</sup>, aged 22, in August 1979 in Preston and Ribble, Lancashire, United Kingdom. They had one daughter:  
 Rachel Jane Watts<sup>2</sup> in 1990  
*This family is shown as family tree 7.*

28. ANDREW JOHN JAMESON (Jane's husband<sup>5</sup>) was born on 5 April 1952. '2005–2010' he resided in Chorley, Lancashire, England, United Kingdom.



Andrew John Jameson married Jane Elizabeth Woods<sup>26</sup>. See family tree 8.

29. RICHARD GEORGE WOODS (Jane's brother<sup>3</sup>) was born in April 1946, in Lancaster, Lancashire, to Peter Anthony Woods<sup>60</sup> and Beatrix Marian Hulton<sup>61</sup>, as shown in family tree 22. '2012–2014' he resided in Durham, County Durham, England.



30. MARGARET MACKENZIE (Jane's sister-in-law<sup>22</sup>) was born in January 1946, in Preston, Lancashire.



Richard George Woods<sup>29</sup>, aged 21, married Margaret Mackenzie, aged 21, in July 1967 in Amounderness, Lancashire, United Kingdom. They had three children:

Jennifer Clare Woods<sup>4</sup> in 1968

Alastair Richard Woods<sup>6</sup> in 1969

Simon Andrew Woods<sup>8</sup> in 1970

This family is shown as family tree 9.

31. PETER JOHN WOODS (Jane's brother<sup>4</sup>) was born in September 1949, in Amounderness, Lancashire, to Peter Anthony Woods<sup>60</sup> and Beatrix Marian Hulton<sup>61</sup>, as shown in family tree 22.



32. MICHAEL A E HOPKINS (Jane's cousin<sup>43</sup>) was born in October 1942, in Lunesdale, Lancashire, to Michael A C Hopkins<sup>63</sup> and Elizabeth Helen Woods<sup>62</sup>, as shown in family tree 23. He died in March 1944, aged 1, in Liverpool North, Lancashire, England.

33. ROSEMARY HOPKINS (Jane's cousin<sup>44</sup>) was born in October 1944, in Liverpool North, Lancashire, to Michael A C Hopkins<sup>63</sup> and Elizabeth Helen Woods<sup>62</sup>, as shown in family tree 23.

34. THOMAS B LOGUE (Jane's cousin's husband<sup>85</sup>).

Thomas B Logue married Rosemary Hopkins<sup>33</sup>, aged 19, in July 1964 in Lancaster, Lancashire, United Kingdom. They had three children:

Michael A Logue<sup>10</sup> in 1965

Helen Josephine Logue<sup>11</sup> in 1967

Catherine Alice Logue<sup>12</sup> in 1968

*This family is shown as family tree 10.*

35. DAVID TAYLOR (Jane's cousin<sup>40</sup>) was born in April 1957, in Lunesdale, Lancashire, to Whitendale Taylor<sup>64</sup> and Elizabeth Helen Woods<sup>62</sup>, as shown in family tree 24.

36. VERONICA ANN CAIRNS (Jane's cousin's wife<sup>79</sup>), also recorded as Ann.

David Taylor<sup>35</sup>, aged about 29, married Veronica Ann Cairns in 1986 in Lancaster, Lancashire, United Kingdom. They had two children:

Robert Taylor<sup>13</sup> in 1988

Jennifer Taylor<sup>15</sup> in 1992

*This family is shown as family tree 11.*

37. JOHN A TAYLOR (Jane's cousin<sup>41</sup>) was born in October 1959, in Lancaster, Lancashire, to Whitendale Taylor<sup>64</sup> and Elizabeth Helen Woods<sup>62</sup>, as shown in family tree 24. '2003, 2005-2010' he resided in Lancaster, Lancashire, England, United Kingdom.

38. MARGARET M SWARBRICK (Jane's cousin's wife<sup>80</sup>) was born on 27 April 1960.

John A Taylor<sup>37</sup>, aged about 24, married Margaret M Swarbrick, aged about 24, in 1984 in Garstang, Lancashire, United Kingdom. They had two children:

James William Taylor<sup>17</sup> in 1988

Lynne Margaret Taylor<sup>18</sup> in 1991

*This family is shown as family tree 12.*

39. GAIL SAUNDERS (Jane's cousin<sup>45</sup>) was born to George A Saunders<sup>68</sup> and Jean Margaret Woods<sup>67</sup>, as shown in family tree 26.
40. RAYMOND LISTER (Jane's cousin's husband<sup>87</sup>).  
Raymond Lister married Gail Saunders<sup>39</sup>. They had one daughter:  
Georgina Audrey Lister<sup>19</sup> in 1992  
*This family is shown as family tree 13.*
41. GILLIAN SAUNDERS (Jane's cousin<sup>47</sup>) was born in July 1944, in Birmingham, West Midlands, to George A Saunders<sup>68</sup> and Jean Margaret Woods<sup>67</sup>, as shown in family tree 26.
42. LEONARD STEWART TAYLOR (Jane's cousin's husband<sup>86</sup>) was born on 7 December 1944. '2003–2010' he resided in Newton-Le-Willows, Merseyside, England, United Kingdom.  
Leonard Stewart Taylor, aged 22, married Gillian Saunders<sup>41</sup>, aged 22, in April 1967 in Lunesdale, Lancashire, United Kingdom. See family tree 14.
43. KATHLEEN GRAHAM (Jane's cousin<sup>46</sup>) was born to Robert (Roy) J Graham<sup>70</sup> and Barbara M Woods<sup>69</sup>, as shown in family tree 27.
44. VINCENT UNKNOWN (Jane's cousin's husband<sup>88</sup>).  
Vincent Unknown married Kathleen Graham<sup>43</sup>. See family tree 15.
45. STUART GRAHAM (Jane's cousin<sup>42</sup>) was born to Robert (Roy) J Graham<sup>70</sup> and Barbara M Woods<sup>69</sup>, as shown in family tree 27.
46. PAULA WOODS (Jane's cousin<sup>33</sup>) was born to Alan Robert Woods<sup>71</sup> and Hazel Walton<sup>72</sup>, as shown in family tree 28.
47. NERYS WOODS (Jane's cousin<sup>34</sup>) was born in April 1959, in Wrexham, Denbighshire, to Alan Robert Woods<sup>71</sup> and Hazel Walton<sup>72</sup>, as shown in family tree 28.
48. AMANDA HELEN WOODS (Jane's cousin<sup>35</sup>) was born in January 1967, in Stockport, Cheshire, to Alan Robert Woods<sup>71</sup> and Hazel Walton<sup>72</sup>, as shown in family tree 28. '2003–2010' she resided in Buxton, Derbyshire, England, United Kingdom. In 2018, aged about 51, she resided in Preston, Derbyshire, England.
49. SEAN P MCDONALD (Jane's cousin's husband<sup>76</sup>).  
Sean P McDonald married Amanda Helen Woods<sup>48</sup>, aged about 20, in 1987 in High Peak, Derbyshire, United Kingdom. They had two sons:  
Callum Sean McDonald<sup>20</sup> in 1997  
Connor Alan McDonald<sup>21</sup> in 1997  
*This family is shown as family tree 16.*
50. MR. HULTON (Jane's cousin<sup>57</sup>) was born to Frederick John Hulton<sup>73</sup> and Margaret Helen Smibert<sup>74</sup>, as shown in family tree 29.
51. JUDY SOPHER (Jane's cousin's wife<sup>101</sup>) was born on 7 June 1955 to Tom Sopher and Gette Unknown.  
Mr. Hulton<sup>50</sup> married Judy Sopher. They had two daughters:  
Corrie Hulton<sup>22</sup>  
Tracy Hulton<sup>23</sup>  
*This family is shown as family tree 17.*
52. JAMES WILLIAM HULTON (Jane's cousin<sup>58</sup>) was born on 9 February 1947, in Ontario, to Frederick John Hulton<sup>73</sup> and Margaret Helen Smibert<sup>74</sup>, as shown in family tree 29. He died on 13 February 1947, as an infant, in Tillsonburg, Oxford, Ontario, Canada.
53. PATRICIA HULTON (Jane's cousin<sup>59</sup>) was born on 24 June 1950 to Frederick John Hulton<sup>73</sup> and Margaret Helen Smibert<sup>74</sup>, as shown in family tree 29.
54. JACK ANDERSON (Jane's cousin's husband<sup>104</sup>). He died in November 2020.  
Jack Anderson married Patricia Hulton<sup>53</sup>. They had two sons:  
Dana Anderson<sup>24</sup>  
Sean Anderson<sup>25</sup> in 1977  
*This family is shown as family tree 18.*
55. CATHERINE GILL (Jane's cousin<sup>63</sup>) was born to Kitchener Thomas Joseph Gill<sup>78</sup> and Margaret (Meg) Hulton<sup>77</sup>, as shown in family tree 31.  
Catherine married twice. She was married to Bruce Labelle<sup>56</sup> and Graham Lewis<sup>57</sup>.

56. BRUCE LABELLE (Jane's cousin's husband<sup>108</sup>).  
Bruce Labelle married Catherine Gill<sup>55</sup>. See family tree 19.
57. GRAHAM LEWIS (Jane's cousin's husband<sup>109</sup>).  
Graham Lewis married Catherine Gill<sup>55</sup>. See family tree 20.
58. BRIAN JOSEPH GILL (Jane's cousin<sup>62</sup>) was born to Kitchener Thomas Joseph Gill<sup>78</sup> and Margaret (Meg) Hulton<sup>77</sup>, as shown in family tree 31.  
The following information is also recorded for Brian. Wedding announcement on 25 February 1972, in Montreal, Quebec, Canada.
59. JUDITH IRIS (Jane's cousin's wife<sup>107</sup>).  
Brian Joseph Gill<sup>58</sup> married Judith Iris. See family tree 21.

### Generation of Parents

60. PETER ANTHONY WOODS (Jane's father<sup>1</sup>, see Paternal Ancestry) was born on 12 March 1921, in Nether Kellet, Lancashire, England, to James Anthony Woods<sup>81</sup> and Lucy Ellen Marguerita Parker<sup>82</sup>, as shown in family tree 32. In 1939, aged about 18, he resided in Lancashire, England (Marital Status: Single; Occupation: Clerk & Telegraphist). He resided in Preston, Lancashire, England. He died on 29 May 2007, aged 86, in Preston.



61. BEATRIX MARIAN HULTON (Jane's mother<sup>2</sup>, see Maternal Ancestry) was born on 3 May 1924, in Chester le Street, Durham, to Frederick Blethyn Hulton<sup>83</sup> and Mary Annie Taylor<sup>84</sup>, as shown in family tree 33. In 1931, aged about 7, she resided in Wn, London, Ontario, Canada (Religion: Church of England; Marital Status: Single; Relation to Head of House: Daughter; Occupation: Student). '2003–2008' she resided in Preston, Lancashire, England, United Kingdom. She resided in Preston, Lancashire, England. Beatrix died on 13 September 2008, aged 84, in Preston, Lancashire, England, United Kingdom.



The following information is also recorded for Beatrix. Departure on 3 May 1929, aged 5, in England; Arrival in Quebec, Canada.

Peter Anthony Woods<sup>60</sup>, aged 24, married Beatrix Marian Hulton, aged 21, on 3 May 1945 in Nova Scotia, Canada. They had three children:

Richard George Woods<sup>29</sup> in 1946

Peter John Woods<sup>31</sup> in 1949

Jane Elizabeth Woods<sup>26</sup> in 1957

*This family is shown as family tree 22.*

62. ELIZABETH HELEN WOODS (Jane's aunt<sup>13</sup>) was born on 12 December 1922, in Lunesdale, Lancashire, to James Anthony Woods<sup>81</sup> and Lucy Ellen Marguerita Parker<sup>82</sup>, as shown in family tree 32. In 1939, aged about 16, she resided in Lancashire, England (Marital Status: Single; Occupation: Telephonist Postal). She died in April 1961, aged 38, in Lancaster, Lancashire, England.  
Elizabeth married twice. She was married to Michael A C Hopkins<sup>63</sup> and Whitendale Taylor<sup>64</sup>.

63. MICHAEL A C HOPKINS (Jane's uncle by marriage<sup>37</sup>) was born on 12 June 1917, in Liverpool, Merseyside. He is no longer living.

Michael A C Hopkins, aged 24, married Elizabeth Helen Woods<sup>62</sup>, aged 19, in January 1942 in Lunesdale, Lancashire, United Kingdom. They had two children:

Michael A E Hopkins<sup>32</sup> in 1942

Rosemary Hopkins<sup>33</sup> in 1944

*This family is shown as family tree 23.*

64. WHITENDALE TAYLOR (Jane's uncle by marriage<sup>39</sup>) was born on 23 May 1910, in Clitheroe, Lancashire. He died in July 1964, aged 54, in Preston, Lancashire, England.

Whitendale Taylor, aged 43, married Elizabeth Helen Woods<sup>62</sup>, aged 30, in October 1953 in Lunesdale, Lancashire, United Kingdom. They had two sons:

David Taylor<sup>35</sup> in 1957

John A Taylor<sup>37</sup> in 1959

*This family is shown as family tree 24.*

65. JOHN JAMES MELROSE WOODS (Jane's uncle<sup>11</sup>) was born in January 1924, in Lunesdale, Lancashire, to James Anthony Woods<sup>81</sup> and Lucy Ellen Marguerita Parker<sup>82</sup>, as shown in family tree 32. He died on 2 January 1969, aged 44, in Lancaster.  
The following information is also recorded for John. Probate: on 11 April 1969, in Lancaster.  
John married Mary Price<sup>66</sup>.  
John James Melrose Woods was married in July 1949 in Lunesdale, Lancashire, United Kingdom.
66. MARY PRICE (Jane's aunt by marriage<sup>32</sup>).  
John James Melrose Woods<sup>65</sup> married Mary Price. See family tree 25.
67. JEAN MARGARET WOODS (Jane's aunt<sup>12</sup>) was born in April 1925, in Lunesdale, Lancashire, to James Anthony Woods<sup>81</sup> and Lucy Ellen Marguerita Parker<sup>82</sup>, as shown in family tree 32. She died in November 2001, aged 76.
68. GEORGE A SAUNDERS (Jane's uncle by marriage<sup>38</sup>). He died in 1998.  
George A Saunders married Jean Margaret Woods<sup>67</sup>, aged 18, in July 1943 in Lunesdale, Lancashire, United Kingdom. They had two daughters:  
Gail Saunders<sup>39</sup>  
Gillian Saunders<sup>41</sup> in 1944  
*This family is shown as family tree 26.*
69. BARBARA M WOODS (Jane's aunt<sup>14</sup>) was born on 9 November 1927, in Lunesdale, Lancashire, England, to James Anthony Woods<sup>81</sup> and Lucy Ellen Marguerita Parker<sup>82</sup>, as shown in family tree 32. In 1939, aged about 11, she resided in Lancashire, England (Marital Status: Single; Occupation: Student). She is no longer living.
70. ROBERT (ROY) J GRAHAM (Jane's uncle by marriage<sup>36</sup>). He is no longer living.  
Robert (Roy) J Graham married Barbara M Woods<sup>69</sup>, aged 18, in July 1946 in Lunesdale, Lancashire, United Kingdom. They had two children:  
Kathleen Graham<sup>43</sup>  
Stuart Graham<sup>45</sup>  
*This family is shown as family tree 27.*
71. ALAN ROBERT WOODS (Jane's uncle<sup>10</sup>) was born on 22 March 1935, in Lancaster, Lancashire, to James Anthony Woods<sup>81</sup> and Lucy Ellen Marguerita Parker<sup>82</sup>, as shown in family tree 32. In 1939, aged about 4, he resided in Lancashire, England (Marital Status: Single; Occupation: Under School Age). He resided in High Peak, Derbyshire, England. He died on 15 February 2013, aged 77.
72. HAZEL WALTON (Jane's aunt by marriage<sup>31</sup>) was born in January 1934, in Chapel en le Frith, Derbyshire. She is no longer living.  
Alan Robert Woods<sup>71</sup>, aged 23, married Hazel Walton, aged 24, in April 1958 in Chapel en le Frith, Derbyshire, United Kingdom. They had three daughters:  
Paula Woods<sup>46</sup>  
Nerys Woods<sup>47</sup> in 1959  
Amanda Helen Woods<sup>48</sup> in 1967  
*This family is shown as family tree 28.*
73. FREDERICK JOHN HULTON (Jane's uncle<sup>17</sup>) was born about 1911, in Yorkshire, England, to Frederick Blethyn Hulton<sup>83</sup> and Mary Annie Taylor<sup>84</sup>, as shown in family tree 33. In 1921, aged about 10, he resided in Austwick, Yorkshire (West Riding), England (Relation to Head of House: Grandson). In 1945, aged about 34, he resided in Elgin, Ontario, Canada (Occupation: Lumber Mill). '1995 1996 1997 1998 1999' he resided in Parry Sound, Ontario. Frederick died in 1998, aged about 87, in Parry Sound.  
The following information is also recorded for Frederick. Birth(?) on 9 November 1911, as an infant, in Richmond, Yorkshire North Riding; Departure on 13 April 1929, aged about 17, in England; Arrival in Halifax, Canada.

74. MARGARET HELEN SMIBERT (Jane's aunt by marriage<sup>56</sup>), also recorded as Margaret Helen Smibert, was born on 9 August 1910, in Middlesex, Ontario, Canada, to James Smibert and Hannah Amelia Corsaut. In 1911, as an infant, she resided in Middlesex East, Ontario (Religion: Presbyterian; Marital Status: Single; Relation to Head of House: Daughter). In 1931, aged about 20, she resided in London, Ontario, Canada. She died on 16 November 2006, aged 96, in Beeton, Ontario, Canada.



The following information is also recorded for Margaret. Birth(?) on 9 August 1910, as an infant; Birth(?) on 9 August 1910, as an infant; Death(?) on 16 November 2006, aged 96.

Frederick John Hulton<sup>73</sup>, aged about 31, married Margaret Helen Smibert, aged 32, on 26 December 1942 in London, Middlesex, Ontario, Canada. They had three children:

Mr. Hulton<sup>50</sup>

James William Hulton<sup>52</sup> in 1947

Patricia Hulton<sup>53</sup> in 1950

*This family is shown as family tree 29.*

75. MARY JANET HULTON (Jane's aunt<sup>20</sup>) was born on 21 February 1913, in Northallerton Yorkshire, England, to Frederick Blethyn Hulton<sup>83</sup> and Mary Annie Taylor<sup>84</sup>, as shown in family tree 33. In 1931, aged about 18, she resided in Wn, London, Ontario, Canada (Religion: Church of England; Marital Status: Single; Relation to Head of House: Daughter). In 1975, aged about 62, she resided in Florida. She died on 3 March 2000, aged 87, in Florida.

The following information is also recorded for Mary. Departure on 3 May 1929, aged 16, in England; Arrival in 1929, aged about 16; Arrival in Quebec, Canada.

76. MR. BOULTON (Jane's uncle by marriage<sup>60</sup>). He is no longer living.

Mr. Boulton married Mary Janet Hulton<sup>75</sup>. See family tree 30.

77. MARGARET (MEG) HULTON (Jane's aunt<sup>21</sup>) was born on 13 March 1914, in Yorkshire England, to Frederick Blethyn Hulton<sup>83</sup> and Mary Annie Taylor<sup>84</sup>, as shown in family tree 33. In 1931, aged about 17, she resided in London, Ontario, Canada (Religion: Church of England; Marital Status: Single; Relation to Head of House: Domestic; Occupation: Servante). She died on 20 February 2014, aged 99, in Canada.

The following information is also recorded for Margaret. Departure on 3 May 1929, aged 15, in England; Arrival in 1929, aged about 15; Obituary for Margaret GILL on 25 February 2014, in Montreal, Quebec, Canada; Arrival in Quebec, Canada.

78. KITCHENER THOMAS JOSEPH GILL (Jane's uncle by marriage<sup>61</sup>) was born on 21 May 1916, in Grand Mere, Quebec. He was baptized '1912–1920', in Granby, Québec, Canada. In 1931, aged about 15, he resided in Champlain, Quebec, Canada (Religion: Anglicane; Marital Status: Célibataire; Occupation: Écolier). He died on 1 December 1977, aged 61, in London, Ontario.

The following information is also recorded for Kitchener. Obituary for GILL Kitchener on 3 December 1977, in Montreal, Quebec, Canada; Obituary for GILL Kitchener on 3 December 1977, in Montreal, Quebec, Canada.

Kitchener Thomas Joseph Gill, aged 24, married Margaret (Meg) Hulton<sup>77</sup>, aged 26, on 8 January 1941 in London, Middlesex, Ontario, Canada. They had two children:

Catherine Gill<sup>55</sup>

Brian Joseph Gill<sup>58</sup>

*This family is shown as family tree 31.*

79. RALPH WILLIAM HULTON (Jane's uncle<sup>18</sup>) was born in July 1915, in Northallerton, Yorkshire North Riding, England, to Frederick Blethyn Hulton<sup>83</sup> and Mary Annie Taylor<sup>84</sup>, as shown in family tree 33. He was baptized on 14 July 1915, in Northallerton, Yorkshire, England. He died in July 1927, aged 12, in South Shields, Durham, England.

80. ELIZABETH HUNT (LIBBY) HULTON (Jane's aunt<sup>19</sup>) was born in June 1928, in South Shields, Durham, to Frederick Blethyn Hulton<sup>83</sup> and Mary Annie Taylor<sup>84</sup>, as shown in family tree 33. In 1931, aged about 3, she resided in WV, London, Ontario, Canada (Religion: Church of England; Marital Status: Single; Relation to Head of House: Daughter). She died in 2004, aged about 76, in Ontario, Canada. She was buried in London, Middlesex County, Ontario, Canada.

The following information is also recorded for Elizabeth. Departure on 3 May 1929, as an infant, in England; Arrival in Quebec, Canada.

### Generation of Grandparents

81. JAMES ANTHONY WOODS (Jane's grandfather<sup>8</sup>, see Paternal Ancestry) was born in 1892, in Nether Kellet, Lancashire, England, to James Woods<sup>89</sup> and Elizabeth Ann Shaw<sup>90</sup>, as shown within family tree 32. He died on 11 August 1934, aged about 42, in Nether Kellet, Lancashire, England.

82. LUCY ELLEN MARGUERITA PARKER (Jane's grandmother<sup>9</sup>, see Paternal Ancestry) was born on 24 September 1897, in The Shooting Box, Abbystead, Wyresdale, Lancashire, England, to Henry Parker<sup>91</sup> and Jane Ellen Archbold Smailes Melrose<sup>92</sup>, as shown within family tree 32. In 1939, aged about 41, she resided in Lancashire, England (Marital Status: Widow; Occupation: Unpaid Domestic Duties). She died on 22 October 1976, aged 79, in Charnley Fold House, Bamber Bridge, Preston, Lancashire, England.



James Anthony Woods<sup>81</sup>, aged about 27, married Lucy Ellen Marguerita Parker, aged 22, on 4 February 1920 in St John, Yealand Conyers, Lancashire. They had six children:

Peter Anthony Woods<sup>60</sup> in 1921  
 Elizabeth Helen Woods<sup>62</sup> in 1922  
 John James Melrose Woods<sup>65</sup> in 1924  
 Jean Margaret Woods<sup>67</sup> in 1925  
 Barbara M Woods<sup>69</sup> in 1927  
 Alan Robert Woods<sup>71</sup> in 1935

*This family is shown as family tree 32.*

83. FREDERICK BLETHYN HULTON (Jane's grandfather<sup>15</sup>, see Maternal Ancestry) was born on 6 July 1886, in Seaton Carew, Durham, England, to William Ford Ralph Hulton<sup>93</sup> and Marian Hunt<sup>94</sup>, as shown in family tree 34. In 1931, aged about 44, he resided in Won, London, Ontario, Canada (Religion: Church of England; Marital Status: Married; Relation to Head of House: Head; Occupation: Electrical engineer). He died in 1958, aged about 71, in Ontario, Canada.

The following information is also recorded for Frederick. Arrival in 1929, aged about 42.

84. MARY ANNIE TAYLOR (Jane's grandmother<sup>16</sup>, see Maternal Ancestry) was born on 4 May 1886, in Bedale, Yorkshire North Riding, England, to John Benjamin Taylor<sup>95</sup> and Mary Jennet Robson<sup>96</sup>, as shown in family tree 35. She died on 7 April 1978, aged 91, in Ontario, Canada.

Frederick Blethyn Hulton<sup>83</sup>, aged 24, married Mary Annie Taylor, aged 24, in January 1911 in Bedale, Yorkshire, England. They had six children:

Frederick John Hulton<sup>73</sup> about 1911  
 Mary Janet Hulton<sup>75</sup> in 1913  
 Margaret (Meg) Hulton<sup>77</sup> in 1914  
 Ralph William Hulton<sup>79</sup> in 1915  
 Beatrix Marian Hulton<sup>61</sup> in 1924  
 Elizabeth Hunt (Libby) Hulton<sup>80</sup> in 1928

*This family is shown as family tree 33.*

85. JANET ISABEL TAYLOR (Jane's great-aunt<sup>33</sup>) was born on 6 November 1887, in Bedale, Yorkshire North Riding, to John Benjamin Taylor<sup>95</sup> and Mary Jennet Robson<sup>96</sup>, as shown in family tree 35. She died in December 1966, aged 79, in Northallerton, Yorkshire North Riding, England.
86. ALICE M TAYLOR (Jane's great-aunt<sup>54</sup>) was born in 1890, in Bedale, Yorkshire North Riding, to John Benjamin Taylor<sup>95</sup> and Mary Jennet Robson<sup>96</sup>, as shown in family tree 35. She is no longer living.
87. JOHN W TAYLOR (Jane's great-uncle<sup>52</sup>) was born in 1894, in Bedale, Yorkshire North Riding, to John Benjamin Taylor<sup>95</sup> and Mary Jennet Robson<sup>96</sup>, as shown in family tree 35. He died on 18 March 1917, aged about 22, in France and Flanders.
88. NORAH TAYLOR (Jane's great-aunt<sup>55</sup>) was born in 1899, in Leases Farm, Bedale Yorkshire, England, to John Benjamin Taylor<sup>95</sup> and Mary Jennet Robson<sup>96</sup>, as shown in family tree 35. She died in December 1961, aged about 62, in Northallerton, Yorkshire North Riding, England.

### **Generation of Great-Grandparents**

89. JAMES WOODS (Jane's great-grandfather<sup>27</sup>, see Paternal Ancestry) was born about 1864, in Nether Kellett, Lancashire, England, to Henry Preston Woods<sup>97</sup> and Jane Reynolds<sup>98</sup>, as shown within family tree 32. He died in June 1935, aged about 70, in Lancaster, Lancashire, England.

90. ELIZABETH ANN SHAW (Jane's great-grandmother<sup>28</sup>, see Paternal Ancestry) was born on 21 October 1865, in Caton, Lancashire, England, to Anthony Shaw<sup>99</sup> and Elizabeth Edwards<sup>100</sup>, as shown within family tree 32. She died on 3 May 1945, aged 79, in Lancashire, England.

James Woods<sup>89</sup> married Elizabeth Ann Shaw. They had one son:

James Anthony Woods<sup>81</sup> in 1892

*This family is shown within family tree 32.*

91. HENRY PARKER (Jane's great-grandfather<sup>29</sup>, see Paternal Ancestry) was born on 3 September 1875, in Hayshaw Farm, Scorton, Wyresdale, Lancashire, England, to Joseph Parker<sup>101</sup> and Ruth Coward<sup>102</sup>, as shown within family tree 32. He died in October 1954, aged 79, in Preston, Lancashire, England.



92. JANE ELLEN ARCHBOLD SMAILES MELROSE (Jane's great-grandmother<sup>30</sup>, see Paternal Ancestry) was born on 23 April 1875, in Craster, North Side, Dunstan, Embleton, Northumberland, England, to Peter Melrose<sup>103</sup> and Margaret Smailes<sup>104</sup>, as shown within family tree 32. She died on 17 March 1951, aged 75, in Daisyfield, Green Lane, Lancaster, Lancashire, England.



Jane married Henry Parker<sup>91</sup>.

Jane Ellen Archbold Smailes Melrose was married in April 1897 in Lancaster, Lancashire.

Henry Parker<sup>91</sup>, aged 21, married Jane Ellen Archbold Smailes Melrose, aged 22, on 12 June 1897 in Lancaster Priory, St Mary, Lancashire, England. They had one daughter:

Lucy Ellen Marguerita Parker<sup>82</sup> in 1897

*This family is shown within family tree 32.*

93. WILLIAM FORD RALPH HULTON (Jane's great-grandfather<sup>48</sup>, see Maternal Ancestry) was born in September 1848, in Stokesley, Hambleton District, North Yorkshire, England, to Charles Norleigh Hulton<sup>105</sup> and Mary Ann Watson<sup>106</sup>, as shown in family tree 36. He died on 16 May 1898, aged 49, in Dover, Kent, England.



94. MARIAN HUNT (Jane's great-grandmother<sup>49</sup>, see Maternal Ancestry) was born on 3 May 1848, in Manchester, Lancashire, England, to Richard Thomas Hunt<sup>107</sup> and Elizabeth Willis<sup>108</sup>, as shown within family tree 33. She died on 15 April 1938, aged 89, in Stockton, County Durham, England, United Kingdom.



William Ford Ralph Hulton<sup>93</sup>, aged 29, married Marian Hunt, aged 29, on 23 April 1878 in Saint Mary, Disley, Cheshire, England, United Kingdom. They had one son:

Frederick Blethyn Hulton<sup>83</sup> in 1886

*This family is shown as family tree 34.*

95. JOHN BENJAMIN TAYLOR (Jane's great-grandfather<sup>50</sup>, see Maternal Ancestry) was born on 7 July 1855, in Upsall, Yorkshire, England, to John Taylor<sup>109</sup> and Mary Atlay<sup>110</sup>, as shown within family tree 33. He died on 7 May 1935, aged 79, in Yorkshire, England.

96. MARY JENNET ROBSON (Jane's great-grandmother<sup>51</sup>, see Maternal Ancestry) was born on 28 August 1861, in Ainderby Steeple, Yorkshire, England, to William Robson<sup>111</sup> and Jennet Mackay<sup>112</sup>, as shown within family tree 33. She died on 13 February 1913, aged 51, in Bedale, Yorkshire, England.

John Benjamin Taylor<sup>95</sup> married Mary Jennet Robson. They had five children:

Mary Annie Taylor<sup>84</sup> in 1886

Janet Isabel Taylor<sup>85</sup> in 1887

Alice M Taylor<sup>86</sup> in 1890

John W Taylor<sup>87</sup> in 1894

Norah Taylor<sup>88</sup> in 1899

*This family is shown as family tree 35.*

### **Generation of Great-Great-Grandparents**

97. HENRY PRESTON WOODS (Jane's great-great-grandfather<sup>68</sup>, see Paternal Ancestry) was born about 1830, in Nether Kellet, Lancashire, England. He died in 1907, aged about 77, in Nether Kellet, Lancashire, England.

98. JANE REYNOLDS (Jane's great-great-grandmother<sup>69</sup>, see Paternal Ancestry) was born on 25 January 1825, in St Michael's, Lancashire, England. She died in March 1909, aged 84, in Lancashire, United Kingdom.

Henry Preston Woods<sup>97</sup> married Jane Reynolds. They had one son:

James Woods<sup>89</sup> about 1864

*This family is shown within family tree 32.*

99. ANTHONY SHAW (Jane's great-great-grandfather<sup>70</sup>, see Paternal Ancestry) was born on 20 October 1832, in Quernmore, Lancashire, England. He died in January 1882, aged 49, in Lunesdale, Lancashire, England.

100. ELIZABETH EDWARDS (Jane's great-great-grandmother<sup>71</sup>, see Paternal Ancestry) was born about 1833, in Ludlow, Shropshire, England. She died in January 1912, aged about 78, in Lancashire, United Kingdom.  
 Anthony Shaw<sup>99</sup> married Elizabeth Edwards. They had one daughter:  
 Elizabeth Ann Shaw<sup>90</sup> in 1865  
*This family is shown within family tree 32.*
101. JOSEPH PARKER (Jane's great-great-grandfather<sup>72</sup>, see Paternal Ancestry) was born on 21 July 1841, in 6 Moor Lane, Lancaster, Lancashire, England. He died in March 1925, aged 83, in Lunesdale, Lancashire, England.
102. RUTH COWARD (Jane's great-great-grandmother<sup>73</sup>, see Paternal Ancestry) was born on 4 February 1850, in Halton with Aughton Lancashire, England. She died in December 1923, aged 73, in Lunesdale, Lancashire, England.  
 Joseph Parker<sup>101</sup> married Ruth Coward. They had one son:  
 Henry Parker<sup>91</sup> in 1875  
*This family is shown within family tree 32.*
103. PETER MELROSE (Jane's great-great-grandfather<sup>74</sup>, see Paternal Ancestry) was born on 6 April 1851, in Glensax, Peebles, Peeblesshire, Scotland. He died on 12 January 1932, aged 80, in 25 Portland Street, Lancaster, Lancashire, England.
- 
104. MARGARET SMAILES (Jane's great-great-grandmother<sup>75</sup>, see Paternal Ancestry) was born on 9 June 1852, in Craster, Northumberland, England. She died on 14 December 1934, aged 82, in 25 Portland Street, Lancaster, Lancashire, England.  
 Peter Melrose<sup>103</sup>, aged 23, married Margaret Smailes, aged 22, on 14 February 1875 in Newcastle Cathedral, Newcastle Upon Tyne, Northumberland, England. They had one daughter:  
 Jane Ellen Archbold Smailes Melrose<sup>92</sup> in 1875  
*This family is shown within family tree 32.*
- 
105. CHARLES NORLEIGH HULTON (Jane's great-great-grandfather<sup>93</sup>, see Maternal Ancestry) was born on 10 January 1823, in Deane, Lancashire, England, to William Hulton<sup>113</sup> and Maria Randle Ford<sup>114</sup>, as shown in family tree 37. He died on 2 March 1870, aged 47, in Altona, Börde, Saxony-Anhalt, Germany.  
 Charles married Mary Ann Watson<sup>106</sup>.  
 Charles Norleigh Hulton was married in January 1844 in Stokesley, Yorkshire North Riding.
106. MARY ANN WATSON (Jane's great-great-grandmother<sup>94</sup>, see Maternal Ancestry) was born about 1827, in Stokesley, Yorkshire, England. She died on 27 June 1855, aged about 27, in Durham, England.  
 Charles Norleigh Hulton<sup>105</sup>, aged 21, married Mary Ann Watson, aged about 16, on 13 March 1844 in Stokesley, York, England. They had one son:  
 William Ford Ralph Hulton<sup>93</sup> in 1848  
*This family is shown as family tree 36.*
107. RICHARD THOMAS HUNT (Jane's great-great-grandfather<sup>95</sup>, see Maternal Ancestry) was born on 30 September 1802, in Burford, Oxfordshire, England. He died on 22 September 1874, aged 71, in Cheshire, England.
108. ELIZABETH WILLIS (Jane's great-great-grandmother<sup>96</sup>, see Maternal Ancestry) was born on 28 March 1813, in Lancashire, England. She died in January 1892, aged 78, in Stockport, Cheshire.  
 Richard Thomas Hunt<sup>107</sup>, aged 35, married Elizabeth Willis, aged 25, on 12 June 1838 in Lancaster, St Mary, Lancashire, England, United Kingdom. They had one daughter:  
 Marian Hunt<sup>94</sup> in 1848  
*This family is shown within family tree 33.*
109. JOHN TAYLOR (Jane's great-great-grandfather<sup>97</sup>, see Maternal Ancestry) was born in 1821, in Welbury, North Yorkshire. He died in April 1894, aged about 72, in Northallerton, Yorkshire North Riding.
110. MARY ATLAY (Jane's great-great-grandmother<sup>98</sup>, see Maternal Ancestry) was born about 1829, in Cowesby, Yorkshire, England. She died in July 1884, aged about 55, in Northallerton, Yorkshire North Riding.  
 John Taylor<sup>109</sup>, aged about 31, married Mary Atlay, aged about 23, in September 1852 in Thirsk, Yorkshire - North Riding. They had one son:  
 John Benjamin Taylor<sup>95</sup> in 1855  
*This family is shown within family tree 33.*

111. WILLIAM ROBSON (Jane's great-great-grandfather<sup>99</sup>, see Maternal Ancestry) was born in June 1821, in Ainderby Steeple, Yorkshire, England. He died on 15 April 1896, aged 74, in Ainderby Steeple, Yorkshire, England.
112. JENNET MACKAY (Jane's great-great-grandmother<sup>100</sup>, see Maternal Ancestry) was born in 1822, in Thurso, Caithness, Scotland. She died on 31 May 1905, aged about 82, in Ainderby Steeple, Yorkshire, England.  
William Robson<sup>111</sup> married Jennet Mackay. They had one daughter:  
Mary Jennet Robson<sup>96</sup> in 1861  
*This family is shown within family tree 33.*

### Generation of Great-Great-Great-Grandparents

113. WILLIAM HULTON (Jane's great-great-great-grandfather<sup>112</sup>, see Maternal Ancestry) was born on 23 October 1787, in Over Hulton, Lancashire, England, to William Hulton<sup>115</sup> and Jane Langford Brooke<sup>116</sup>, as shown in family tree 38. He died on 31 March 1864, aged 76, in Leamington Spa, Warwickshire, England.



114. MARIA RANDLE FORD (Jane's great-great-great-grandmother<sup>113</sup>, see Maternal Ancestry) was born in 1790, in London, Middlesex, England. She died on 5 April 1866, aged about 75, in Warwick, Warwickshire.  
William Hulton<sup>113</sup>, aged 21, married Maria Randle Ford, aged about 18, on 25 October 1808 in Wexham, Buckingham, England. They had one son:  
Charles Norleigh Hulton<sup>105</sup> in 1823  
*This family is shown as family tree 37.*

### Generation of Four-Times-Great-Grandparents

115. WILLIAM HULTON (Jane's four-times-great-grandfather<sup>114</sup>, see Maternal Ancestry) was born on 28 May 1762 to William Hulton<sup>118</sup> and Ann Hall<sup>119</sup>, as shown in family tree 40. He died on 24 June 1800, aged 38.



116. JANE LANGFORD BROOKE (Jane's four-times-great-grandmother<sup>115</sup>, see Maternal Ancestry) was born on 7 August 1764, in Rostherne, Cheshire, England. She died on 7 December 1845, aged 81, in Marylebone, Middlesex, England.  
Jane married twice. She was married to William Hulton<sup>115</sup> and William Tyrrell Boyce<sup>117</sup>.  
William Hulton<sup>115</sup>, aged 23, married Jane Langford Brooke, aged 21, on 23 August 1785 in Rostherne, Cheshire, England. They had one son:  
William Hulton<sup>113</sup> in 1787  
*This family is shown as family tree 38.*
117. WILLIAM TYRRELL BOYCE (Jane's step-four-times-great-grandfather<sup>118</sup>) was born on 24 October 1780, in Croydon, Surrey. He died in July 1838, aged 57, in Calais, France.  
William Tyrrell Boyce, aged 23, married Jane Langford Brooke<sup>116</sup>, aged 39, on 7 May 1804 in Deane, Lancashire, England. See family tree 39.

### Generation of Five-Times-Great-Grandparents

118. WILLIAM HULTON (Jane's five-times-great-grandfather<sup>116</sup>, see Maternal Ancestry) was born on 6 October 1739, in Hulton Park, Cheshire, England, to William Hulton<sup>120</sup> and Mary Leigh<sup>121</sup>, as shown in family tree 41. He died in 1775, aged about 35, in Nice, France.



119. ANN HALL (Jane's five-times-great-grandmother<sup>117</sup>, see Maternal Ancestry) was born in 1742, in Little Hulton, Lancashire, England. She died in 1802, aged about 60, in Little Hulton, Lancashire, England.  
 William Hulton<sup>118</sup> married Ann Hall. They had one son:  
 William Hulton<sup>115</sup> in 1762  
*This family is shown as family tree 40.*

### Generation of Six-Times-Great-Grandparents

120. WILLIAM HULTON (Jane's six-times-great-grandfather<sup>119</sup>, see Maternal Ancestry) was born on 22 June 1717, in Hulton Park, Over Hulton, Lancashire, to Jessop Hulton<sup>122</sup> and Mary Haseldean<sup>123</sup>, as shown in family tree 42. He died in April 1741, aged 23, in Hulton Park, Over Hulton, Lancashire.



121. MARY LEIGH (Jane's six-times-great-grandmother<sup>120</sup>, see Maternal Ancestry) was born in 1714, in Westhoughton, Lancashire, England. She died about 1766, aged about 52.  
 William Hulton<sup>120</sup> married Mary Leigh. They had one son:  
 William Hulton<sup>118</sup> in 1739  
*This family is shown as family tree 41.*

### Generation of Seven-Times-Great-Grandparents

122. JESSOP HULTON (Jane's seven-times-great-grandfather<sup>121</sup>, see Maternal Ancestry) was born in 1667, in Hulton Park, Deane, Lancashire, England, to William Hulton<sup>124</sup> and Anne Jessop<sup>125</sup>, as shown in family tree 43. He died in 1725, aged about 58, in Hulton Park, Deane, Lancashire, England.



123. MARY HASELDEAN (Jane's seven-times-great-grandmother<sup>122</sup>, see Maternal Ancestry) was born in 1688, in Hulton Park, Lancashire, England. She died on 6 July 1726, aged about 38, in Deane-By-Bolton, Lancashire, England.  
 Jessop Hulton<sup>122</sup> married Mary Haseldean. They had one son:  
 William Hulton<sup>120</sup> in 1717  
*This family is shown as family tree 42.*

### Generation of Eight-Times-Great-Grandparents

124. WILLIAM HULTON (Jane's eight-times-great-grandfather<sup>123</sup>, see Maternal Ancestry) was born on 9 September 1625, in Hulton Hall, Hulton Park, Over Hulton, Deane, Lancashire, England, to Adam Hulton<sup>126</sup> and Grace Howarth<sup>127</sup>, as shown in family tree 44. He died on 27 May 1694, aged 68, in Hulton Hall, Hulton Park, Over Hulton, Deane, Lancashire, England.



125. ANNE JESSOP (Jane's eight-times-great-grandmother<sup>124</sup>, see Maternal Ancestry) was born about 1629, in Warwick House, High Holburn, Middlesex, London, England. She died on 16 December 1677, aged about 48, in Hulton Hall, Hulton Park, Over Hulton, Deane, Lancashire, England.  
 William Hulton<sup>124</sup> married Anne Jessop. They had one son:  
 Jessop Hulton<sup>122</sup> in 1667  
 This family is shown as family tree 43.



### Generation of Nine-Times-Great-Grandparents

126. ADAM HULTON (Jane's nine-times-great-grandfather<sup>125</sup>, see Maternal Ancestry) was born on 1 July 1607, in Hulton Park, (Deane), Lancashire, England, United Kingdom, to William Hulton<sup>128</sup> and Katherine Hyde<sup>129</sup>, as shown in family tree 45. He died on 16 September 1651, aged 44, in Hulton Park, (16)(Deane), Lancashire, England, United Kingdom.

127. GRACE HOWARTH (Jane's nine-times-great-grandmother<sup>126</sup>, see Maternal Ancestry). She is no longer living. Adam Hulton<sup>126</sup> married Grace Howarth. They had one son:  
 William Hulton<sup>124</sup> in 1625  
*This family is shown as family tree 44.*

#### **Generation of Ten-Times-Great-Grandparents**

128. WILLIAM HULTON (Jane's ten-times-great-grandfather<sup>127</sup>, see Maternal Ancestry) was born in 1576 to Adam Hulton<sup>130</sup> and Alice Baguley<sup>131</sup>, as shown in family tree 46. He died on 6 September 1613, aged about 37.
129. KATHERINE HYDE (Jane's ten-times-great-grandmother<sup>128</sup>, see Maternal Ancestry) was born in 1581. She died in 1655, aged about 74.  
 William Hulton<sup>128</sup> married Katherine Hyde. They had one son:  
 Adam Hulton<sup>126</sup> in 1607  
*This family is shown as family tree 45.*

#### **Generation of Eleven-Times-Great-Grandparents**

130. ADAM HULTON (Jane's eleven-times-great-grandfather<sup>129</sup>, see Maternal Ancestry) was born on 4 February 1557, in Of Hulton Park, to William (The Patriarch) Hulton<sup>132</sup> and Margaret Keighley<sup>133</sup>, as shown in family tree 47. He died on 29 December 1597, aged 40, in Deane, Lancashire, England.
131. ALICE BAGULEY (Jane's eleven-times-great-grandmother<sup>130</sup>, see Maternal Ancestry) was born in 1551, in Manchester, Lancashire, England. She died in 1647, aged about 96.  
 Adam Hulton<sup>130</sup>, aged about 10, married Alice Baguley, aged about 16, in 1567 in Hulton Park, Lancashire, England, United Kingdom. They had one son:  
 William Hulton<sup>128</sup> in 1576  
*This family is shown as family tree 46.*

#### **Generation of Twelve-Times-Great-Grandparents**

132. WILLIAM (THE PATRIARCH) HULTON (Jane's twelve-times-great-grandfather<sup>131</sup>, see Maternal Ancestry) was born in 1540, in Hulton Park, Over Hulton, Westhoughton, Bolton, Deane, Lancashire, England, to Adam Hulton<sup>134</sup> and Clemence Norris<sup>135</sup>, as shown in family tree 48. He died on 18 August 1624, aged about 84, in Hulton Park, Over Hulton, Westhoughton, Bolton, Deane, Lancashire, England.  
 William married Margaret Keighley<sup>133</sup>.  
 William (The Patriarch) Hulton was married in 1580.
133. MARGARET KEIGHLEY (Jane's twelve-times-great-grandmother<sup>132</sup>, see Maternal Ancestry) was born in 1545, in Keighley, West Riding, Yorkshire, West Yorkshire, England. She is no longer living.  
 William (The Patriarch) Hulton<sup>132</sup> married Margaret Keighley. They had one son:  
 Adam Hulton<sup>130</sup> in 1557  
*This family is shown as family tree 47.*

#### **Generation of Thirteen-Times-Great-Grandparents**

134. ADAM HULTON (Jane's thirteen-times-great-grandfather<sup>133</sup>, see Maternal Ancestry) was born in 1519, in Hulton Hall, Hulton Park, Over Hulton, Deane, Lancashire, England, to William Hulton<sup>136</sup> and Elizabeth Legh<sup>137</sup>, as shown in family tree 49. He died on 29 September 1573, aged about 54, in Hulton Hall, Hulton Park, Over Hulton, Deane, Lancashire, England.
135. CLEMENCE NORRIS (Jane's thirteen-times-great-grandmother<sup>134</sup>, see Maternal Ancestry) was born in 1509, in Liverpool, Lancashire, England. She died on 5 February 1595, aged about 85, in Hulton Hall, Hulton Park, Hulton, Lancashire, England.  
 Adam Hulton<sup>134</sup>, aged about 15, married Clemence Norris, aged about 25, in November 1534. They had one son:  
 William (The Patriarch) Hulton<sup>132</sup> in 1540  
*This family is shown as family tree 48.*

**Generation of Fourteen-Times-Great-Grandparents**

136. WILLIAM HULTON (Jane's fourteen-times-great-grandfather<sup>135</sup>, see Maternal Ancestry) was born in 1497, in Hulton Hall, Hulton Park, Over Hulton, Deane, Lancashire, England, to Adam Hulton<sup>138</sup> and Alicia Hulton<sup>139</sup>, as shown in family tree 50. He died in 1554, aged about 57, in Hulton Hall, Hulton Park, Over Hulton, Deane, Lancashire, England.
137. ELIZABETH LEGH (Jane's fourteen-times-great-grandmother<sup>136</sup>, see Maternal Ancestry) was born in 1497, in Holford, Cheshire, England. She died in 1560, aged about 63, in Hulton Hall, Hulton Park, Over Hulton, Deane, Lancashire, England.  
 William Hulton<sup>136</sup> married Elizabeth Legh. They had one son:  
 Adam Hulton<sup>134</sup> in 1519  
*This family is shown as family tree 49.*

**Generation of Fifteen-Times-Great-Grandparents**

138. ADAM HULTON (Jane's fifteen-times-great-grandfather<sup>137</sup>, see Maternal Ancestry) was born in 1467, in Hulton Park Hall, Over Hulton, Bolton, Deane, Lancashire, England, to Roger Hulton<sup>140</sup> and Katherine Harrington<sup>141</sup>, as shown in family tree 51. He died on 13 February 1530, aged about 62, in Hulton Park, Over Hulton, Bolton, Deane, Lancashire, England.



139. ALICIA HULTON (Jane's fifteen-times-great-grandmother<sup>138</sup>, see Maternal Ancestry) was born about 1469, in Farnworth, Lancashire, England, to John Hulton<sup>142</sup> and Joan Garnet<sup>143</sup>, as shown in family tree 52. She died about 1540, aged about 71, in Farnworth, Lancashire, England.  
 Adam Hulton<sup>138</sup>, aged about 21, married Alicia Hulton, aged about 19, in May 1489. They had one son:  
 William Hulton<sup>136</sup> in 1497  
 This family is shown as family tree 50.

**Generation of Sixteen-Times-Great-Grandparents**

140. ROGER HULTON (Jane's sixteen-times-great-grandfather<sup>139</sup>, see Maternal Ancestry) was born in 1450 to Roger Hulton<sup>144</sup> and Helen Farnsworth<sup>145</sup>, as shown in family tree 53. He died in 1520, aged about 70.



141. KATHERINE HARRINGTON (Jane's sixteen-times-great-grandmother<sup>140</sup>, see Maternal Ancestry) was born in 1449. She died in 1500, aged about 51.  
 Roger Hulton<sup>140</sup> married Katherine Harrington. They had one son:  
 Adam Hulton<sup>138</sup> in 1467  
 This family is shown as family tree 51.



142. JOHN HULTON (Jane's sixteen-times-great-grandfather<sup>141</sup>, see Maternal Ancestry) was born in 1452 to William Hulton<sup>146</sup> and Margaret Tyldesley<sup>147</sup>, as shown in family tree 54. He died in 1503, aged about 51.
143. JOAN GARNET (Jane's sixteen-times-great-grandmother<sup>142</sup>, see Maternal Ancestry). She is no longer living.  
 John Hulton<sup>142</sup> married Joan Garnet. They had one daughter:  
 Alicia Hulton<sup>139</sup> about 1469  
*This family is shown as family tree 52.*

**Generation of Seventeen-Times-Great-Grandparents**

144. ROGER HULTON (Jane's seventeen-times-great-grandfather<sup>143</sup>, see Maternal Ancestry) was born in 1410 to Roger De Hulton<sup>148</sup> and Elena De Hulton<sup>149</sup>, as shown in family tree 55. He is no longer living.
145. HELEN FARNSWORTH ? (Jane's seventeen-times-great-grandmother<sup>144</sup>, see Maternal Ancestry) was born in 1405. She died in 1460, aged about 55.  
Roger Hulton<sup>144</sup> married Helen Farnsworth ?. They had one son:  
Roger Hulton<sup>140</sup> in 1450  
*This family is shown as family tree 53.*
146. WILLIAM HULTON (Jane's seventeen-times-great-grandfather<sup>145</sup>, see Maternal Ancestry) was born in 1419 to James De Hulton<sup>150</sup> and Elizabeth Radcliffe<sup>151</sup>, as shown within family tree 52. He is no longer living.
147. MARGARET TYLDESLEY (Jane's seventeen-times-great-grandmother<sup>146</sup>, see Maternal Ancestry) was born in 1413. She is no longer living.  
William Hulton<sup>146</sup> married Margaret Tyldesley. They had one son:  
John Hulton<sup>142</sup> in 1452  
*This family is shown as family tree 54.*

**Generation of Eighteen-Times-Great-Grandparents**

148. ROGER DE HULTON (Jane's eighteen-times-great-grandfather<sup>147</sup>, see Maternal Ancestry) was born in 1386 to Adam De Hulton<sup>152</sup> and Alice De Culcheth ?<sup>153</sup>, as shown in family tree 56. He died in 1459, aged about 73.
149. ELENA DE HULTON (Jane's eighteen-times-great-grandmother<sup>148</sup>, see Maternal Ancestry) was born in 1388 to John De Hulton<sup>154</sup> and Isabella Atherton<sup>155</sup>, as shown in family tree 57. She is no longer living.  
Roger De Hulton<sup>148</sup> married Elena De Hulton. They had one son:  
Roger Hulton<sup>144</sup> in 1410  
*This family is shown as family tree 55.*
150. JAMES DE HULTON (Jane's eighteen-times-great-grandfather<sup>149</sup>, see Maternal Ancestry) was born in 1388 to John De Hulton<sup>154</sup> and Isabella Atherton<sup>155</sup>, as shown in family tree 57. He is no longer living.
151. ELIZABETH RADCLIFFE (Jane's eighteen-times-great-grandmother<sup>150</sup>, see Maternal Ancestry). She is no longer living.  
James De Hulton<sup>150</sup> married Elizabeth Radcliffe. They had one son:  
William Hulton<sup>146</sup> in 1419  
*This family is shown within family tree 52.*

**Generation of Nineteen-Times-Great-Grandparents**

152. ADAM DE HULTON (Jane's nineteen-times-great-grandfather<sup>151</sup>, see Maternal Ancestry(1)) was born in 1366 to Roger De Hulton<sup>156</sup> and Agnes De Legh<sup>157</sup>, as shown in family tree 58. He died in 1431, aged about 65.
153. ALICE DE CULCHETH ? (Jane's nineteen-times-great-grandmother<sup>152</sup>, see Maternal Ancestry(1)) was born in 1366. She is no longer living.  
Adam De Hulton<sup>152</sup> married Alice De Culcheth ?. They had one son:  
Roger De Hulton<sup>148</sup> in 1386  
*This family is shown as family tree 56.*
154. JOHN DE HULTON (Jane's nineteen-times-great-grandfather<sup>153</sup>, see Maternal Ancestry(2) and Maternal Ancestry(3)) was born in 1358. He is no longer living.
155. ISABELLA ATHERTON (Jane's nineteen-times-great-grandmother<sup>154</sup>, see Maternal Ancestry(2) and Maternal Ancestry(3)) was born in 1362. She is no longer living.  
John De Hulton<sup>154</sup> married Isabella Atherton. They had two children:  
Elena De Hulton<sup>149</sup> in 1388  
James De Hulton<sup>150</sup> in 1388  
*This family is shown as family tree 57.*

**Generation of Twenty-Times-Great-Grandparents**

156. ROGER DE HULTON (Jane's twenty-times-great-grandfather<sup>155</sup>, see Maternal Ancestry(1)) was born in 1350 to Roger De Hulton<sup>158</sup> and Alyne De Lever<sup>159</sup>, as shown in family tree 59. He died in 1411, aged about 61.
157. AGNES DE LEGH (Jane's twenty-times-great-grandmother<sup>156</sup>, see Maternal Ancestry(1)) was born in 1349. She is no longer living.  
 Roger De Hulton<sup>156</sup> married Agnes De Legh. They had one son:  
 Adam De Hulton<sup>152</sup> in 1366  
*This family is shown as family tree 58.*

**Generation of Twenty-one-Times-Great-Grandparents**

158. ROGER DE HULTON (Jane's twenty-one-times-great-grandfather<sup>157</sup>, see Maternal Ancestry(1)) was born in 1336 to Adam De Hulton<sup>160</sup> and Alicia De Eccles<sup>161</sup>, as shown in family tree 60. He is no longer living.
159. ALYNE DE LEVER (Jane's twenty-one-times-great-grandmother<sup>158</sup>, see Maternal Ancestry(1)) was born in 1335. She is no longer living.  
 Roger De Hulton<sup>158</sup> married Alyne De Lever. They had one son:  
 Roger De Hulton<sup>156</sup> in 1350  
*This family is shown as family tree 59.*

**Generation of Twenty-two-Times-Great-Grandparents**

160. ADAM DE HULTON (Jane's twenty-two-times-great-grandfather<sup>159</sup>, see Maternal Ancestry(1)) was born in 1285 to Richard De Hulton<sup>162</sup> and Margeria Radcliffe<sup>163</sup>, as shown in family tree 61. He is no longer living.
161. ALICIA DE ECCLES (Jane's twenty-two-times-great-grandmother<sup>160</sup>, see Maternal Ancestry(1)) was born in 1308. She is no longer living.  
 Adam De Hulton<sup>160</sup> married Alicia De Eccles. They had one son:  
 Roger De Hulton<sup>158</sup> in 1336  
*This family is shown as family tree 60.*

**Generation of Twenty-three-Times-Great-Grandparents**

162. RICHARD DE HULTON (Jane's twenty-three-times-great-grandfather<sup>161</sup>, see Maternal Ancestry(1)) was born in 1230 to David De Hulton<sup>164</sup> and Agnes De Blackburne<sup>165</sup>, as shown in family tree 62. He died in 1298, aged about 68.
163. MARGERIA RADCLIVE (Jane's twenty-three-times-great-grandmother<sup>162</sup>, see Maternal Ancestry(1)) was born in 1235. She died in 1312, aged about 77.  
 Richard De Hulton<sup>162</sup> married Margeria Radcliffe. They had one son:  
 Adam De Hulton<sup>160</sup> in 1285  
*This family is shown as family tree 61.*

**Generation of Twenty-four-Times-Great-Grandparents**

164. DAVID DE HULTON (Jane's twenty-four-times-great-grandfather<sup>163</sup>, see Maternal Ancestry(1)) was born in 1194 to Richard De Hulton<sup>166</sup> and Ellen Ridiche<sup>?167</sup>, as shown in family tree 63. He died in 1285, aged about 91.
165. AGNES DE BLACKBURNE (Jane's twenty-four-times-great-grandmother<sup>164</sup>, see Maternal Ancestry(1)) was born in 1202. She is no longer living.  
 David De Hulton<sup>164</sup> married Agnes De Blackburne. They had one son:  
 Richard De Hulton<sup>162</sup> in 1230  
*This family is shown as family tree 62.*

**Generation of Twenty-five-Times-Great-Grandparents**

166. RICHARD DE HULTON (Jane's twenty-five-times-great-grandfather<sup>165</sup>, see Maternal Ancestry(1)) was born in 1180 to Jorveth (Yarwrit) De Hulton<sup>168</sup> and Christiana De Alreton<sup>169</sup>, as shown within family tree 63. He died in 1230, aged about 50.
167. ELLEN RIDICHE ? (Jane's twenty-five-times-great-grandmother<sup>166</sup>, see Maternal Ancestry(1)) was born in 1164. She is no longer living.  
 Richard De Hulton<sup>166</sup> married Ellen Ridiche ?. They had one son:  
 David De Hulton<sup>164</sup> in 1194  
*This family is shown as family tree 63.*

**Generation of Twenty-six-Times-Great-Grandparents**

168. JORVETH (YARWRIT) DE HULTON (Jane's twenty-six-times-great-grandfather<sup>167</sup>, see Maternal Ancestry(1)) was born in 1145 to Blethyn De Hulton<sup>170</sup>, as shown within family tree 63. He is no longer living.
169. CHRISTIANA DE ALRETON ? (Jane's twenty-six-times-great-grandmother<sup>168</sup>, see Maternal Ancestry(1)) was born in 1164. She is no longer living.  
 Jorveth (Yarwrit) De Hulton<sup>168</sup> married Christiana De Alreton ?. They had one son:  
 Richard De Hulton<sup>166</sup> in 1180  
*This family is shown within family tree 63.*

**Generation of Twenty-seven-Times-Great-Grandparents**

170. BLETHYN DE HULTON (Jane's twenty-seven-times-great-grandfather<sup>169</sup>, see Maternal Ancestry(1)) was born in 1110. He died in 1162, aged about 52.  
 The following information is also recorded for Blethyn. Story (This family is of Welsh origin; the first Lancashire members of it—Iorwerth (d. 1215) and Madoc, sons of Bleiddyn—are supposed to have been among the faithful vassals of Robert Banastre, expelled from Wales about 1167) in 1160, aged about 50.  
 Blethyn fathered one son:  
 Jorveth (Yarwrit) De Hulton<sup>168</sup> in 1145  
*This family is shown within family tree 63.*

**6. FAMILY TREES**

1. SLACK, Michael Lee and WATTS, Rachel Jane
2. ROWSON, David and WOODS, Jennifer Clare
3. WOODS, Alastair Richard and UNKNOWN, Kirsten
4. WOODS, Simon Andrew and WILSON, Dawn
5. TAYLOR, Robert and UNKNOWN, Laura
6. HESLOP, Chris and TAYLOR, Jennifer
7. WATTS, Martin Craig and WOODS, Jane Elizabeth
8. JAMESON, Andrew John and WOODS, Jane Elizabeth
9. WOODS, Richard George and MACKENZIE, Margaret
10. LOGUE, Thomas B and HOPKINS, Rosemary
11. TAYLOR, David and CAIRNS, Veronica Ann
12. TAYLOR, John A and SWARBRICK, Margaret M
13. LISTER, Raymond and SAUNDERS, Gail
14. TAYLOR, Leonard Stewart and SAUNDERS, Gillian
15. UNKNOWN, Vincent and GRAHAM, Kathleen
16. MCDONALD, Sean P and WOODS, Amanda Helen
17. HULTON, Mr. and SOPHER, Judy
18. ANDERSON, Jack and HULTON, Patricia
19. LABELLE, Bruce and GILL, Catherine
20. LEWIS, Graham and GILL, Catherine
21. GILL, Brian Joseph and IRIS, Judith
22. WOODS, Peter Anthony and HULTON, Beatrix Marian
23. HOPKINS, Michael A C and WOODS, Elizabeth Helen
24. TAYLOR, Whitendale and WOODS, Elizabeth Helen
25. WOODS, John James Melrose and PRICE, Mary
26. SAUNDERS, George A and WOODS, Jean Margaret
27. GRAHAM, Robert (Roy) J and WOODS, Barbara M
28. WOODS, Alan Robert and WALTON, Hazel
29. HULTON, Frederick John and SMIBERT, Margaret Helen
30. BOULTON, Mr. and HULTON, Mary Janet
31. GILL, Kitchener Thomas Joseph and HULTON, Margaret (Meg)
32. WOODS, James Anthony and PARKER, Lucy Ellen Marguerita
33. HULTON, Frederick Blethyn and TAYLOR, Mary Annie
34. HULTON, William Ford Ralph and HUNT, Marian
35. TAYLOR, John Benjamin and ROBSON, Mary Jennet
36. HULTON, Charles Norleigh and WATSON, Mary Ann
37. HULTON, William and FORD, Maria Randle
38. HULTON, William and BROOKE, Jane Langford
39. BOYCE, William Tyrrell and BROOKE, Jane Langford
40. HULTON, William and HALL, Ann
41. HULTON, William and LEIGH, Mary
42. HULTON, Jessop and HASELDEAN, Mary
43. HULTON, William and JESSOP, Anne
44. HULTON, Adam and HOWARTH, Grace
45. HULTON, William and HYDE, Katherine
46. HULTON, Adam and BAGULEY, Alice
47. HULTON, William (The Patriarch) and KEIGHLEY, Margaret
48. HULTON, Adam and NORRIS, Clemence
49. HULTON, William and LEGH, Elizabeth
50. HULTON, Adam and HULTON, Alicia
51. HULTON, Roger and HARRINGTON, Katherine
52. HULTON, John and GARNET, Joan
53. HULTON, Roger and FARNSWORTH, Helen, ?
54. HULTON, William and TYLDESLEY, Margaret
55. HULTON, Roger De and HULTON, Elena De
56. HULTON, Adam De and CULCHETH, Alice De, ?
57. HULTON, John De and ATHERTON, Isabella
58. HULTON, Roger De and LEGH, Agnes De
59. HULTON, Roger De and LEVER, Alyne De
60. HULTON, Adam De and ECCLES, Alicia De
61. HULTON, Richard De and RADCLIVE, Margeria
62. HULTON, David De and BLACKBURNE, Agnes De
63. HULTON, Richard De and RIDICHE, Ellen, ?

**1. Michael Lee Slack and Rachel Jane Watts**

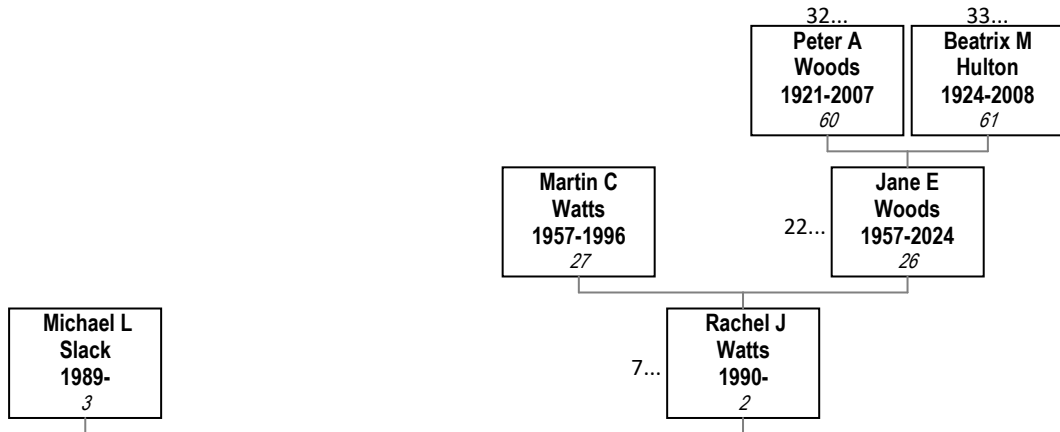

**2. David Rowson and Jennifer Clare Woods**

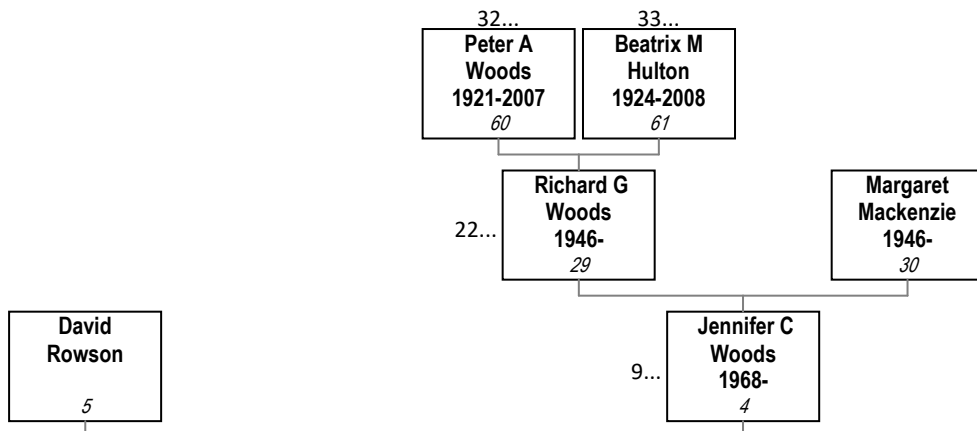

**3. Alastair Richard Woods and Kirsten Unknown**

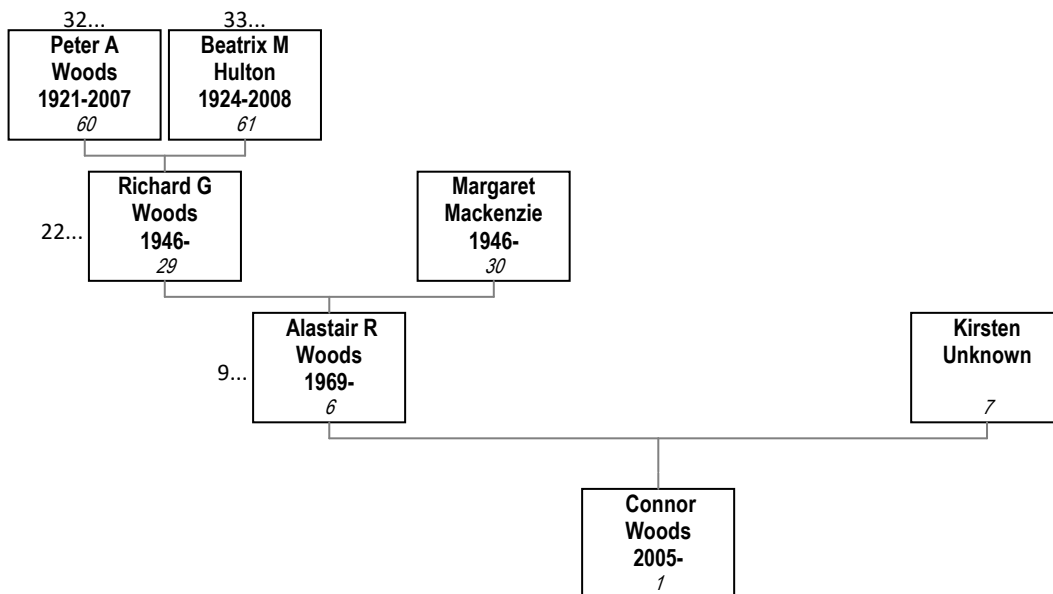

**4. Simon Andrew Woods and Dawn Wilson**

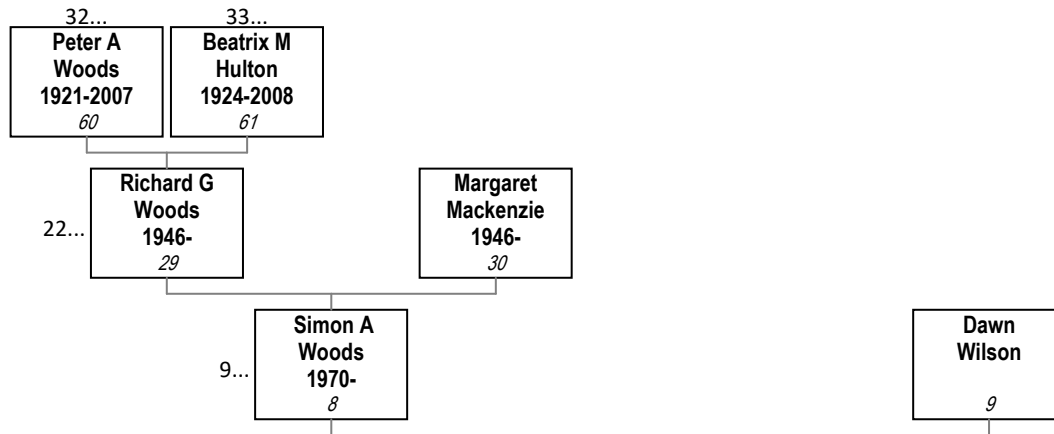

**5. Robert Taylor and Laura Unknown**

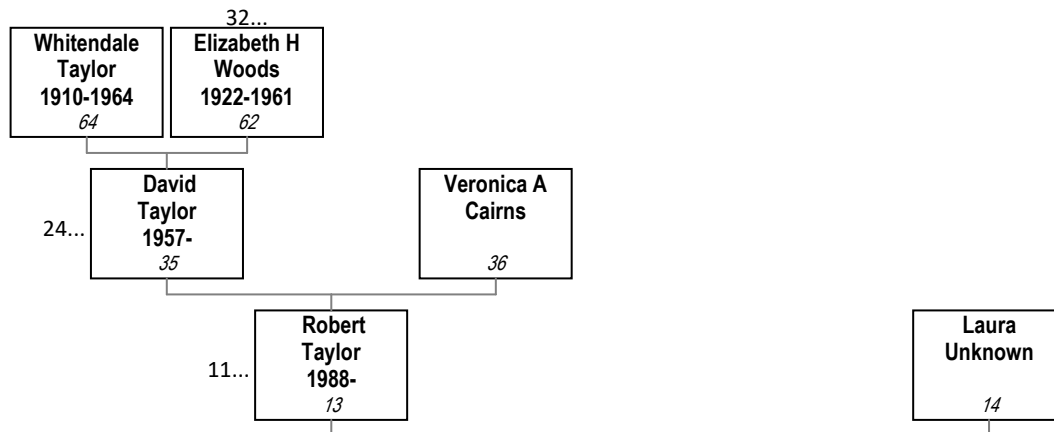

**6. Chris Heslop and Jennifer Taylor**

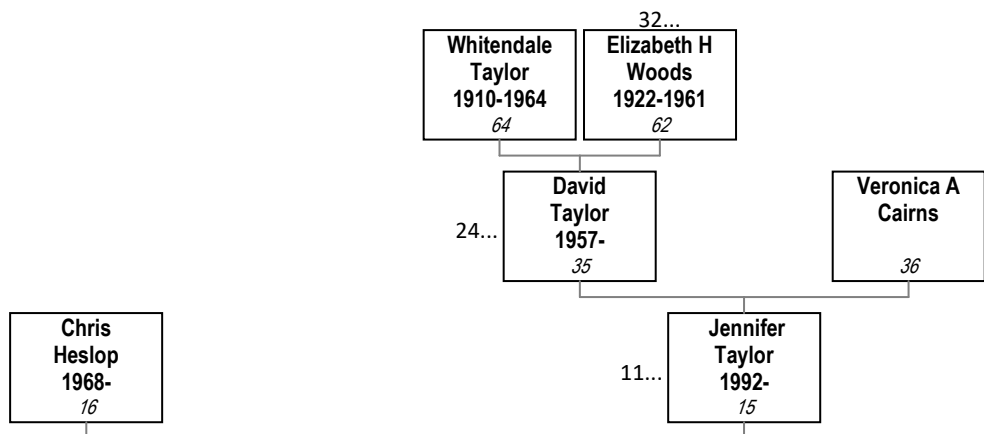

**7. Martin Craig Watts and Jane Elizabeth Woods**

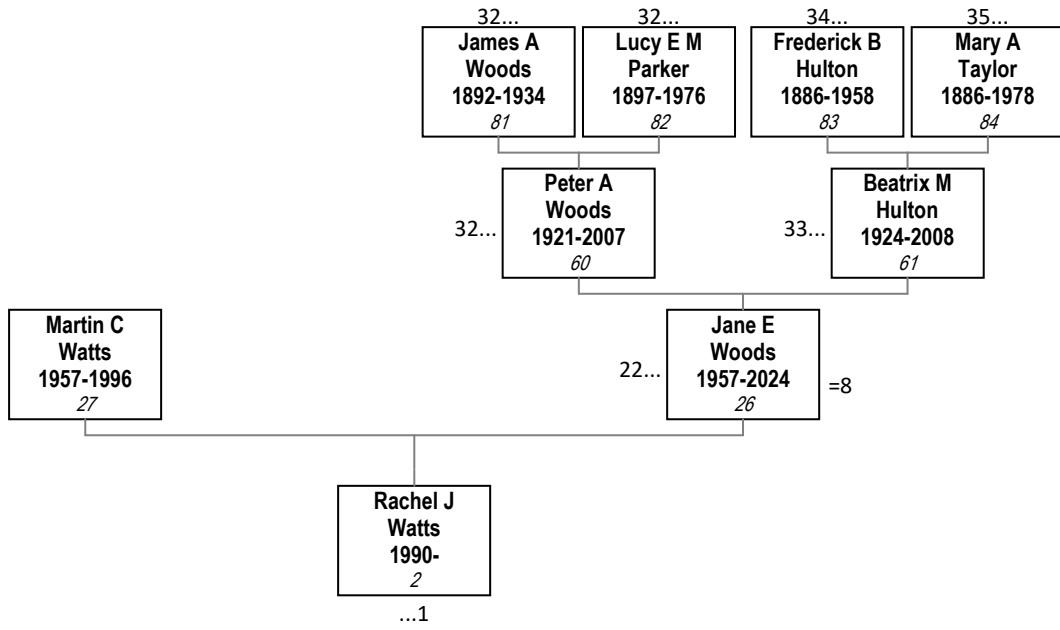

**8. Andrew John Jameson and Jane Elizabeth Woods**

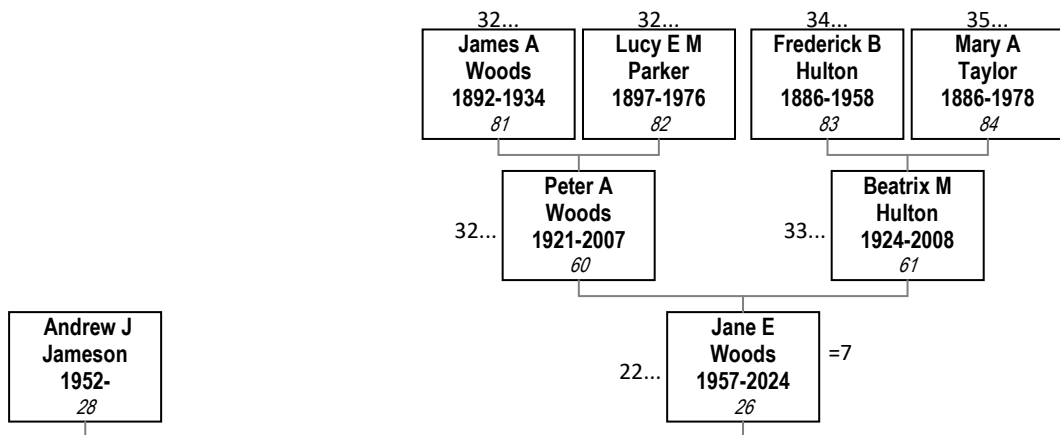

**9. Richard George Woods and Margaret Mackenzie**

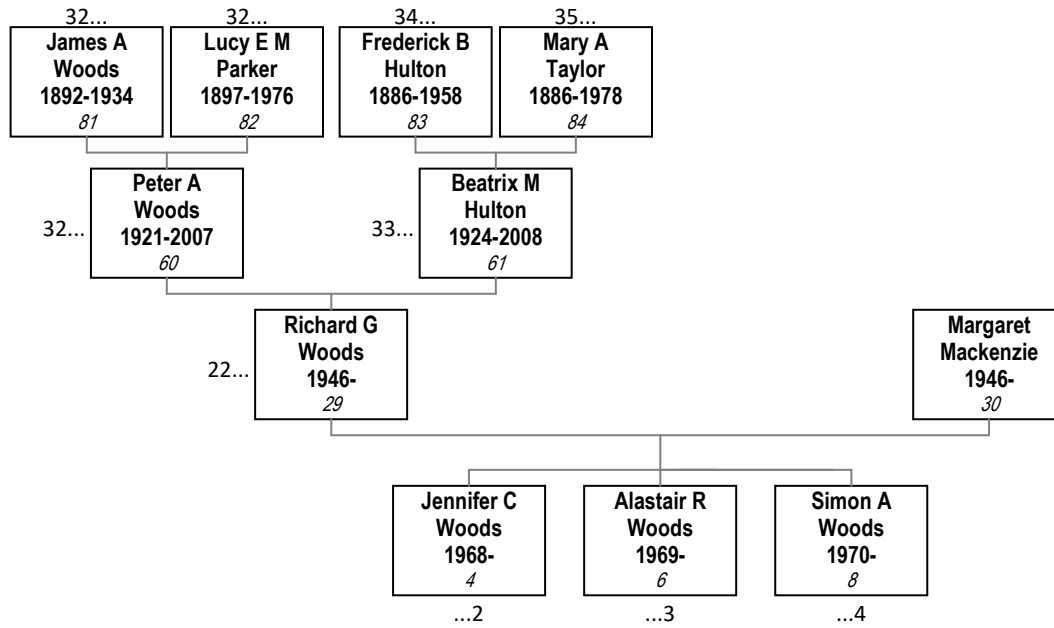

**10. Thomas B Logue and Rosemary Hopkins**

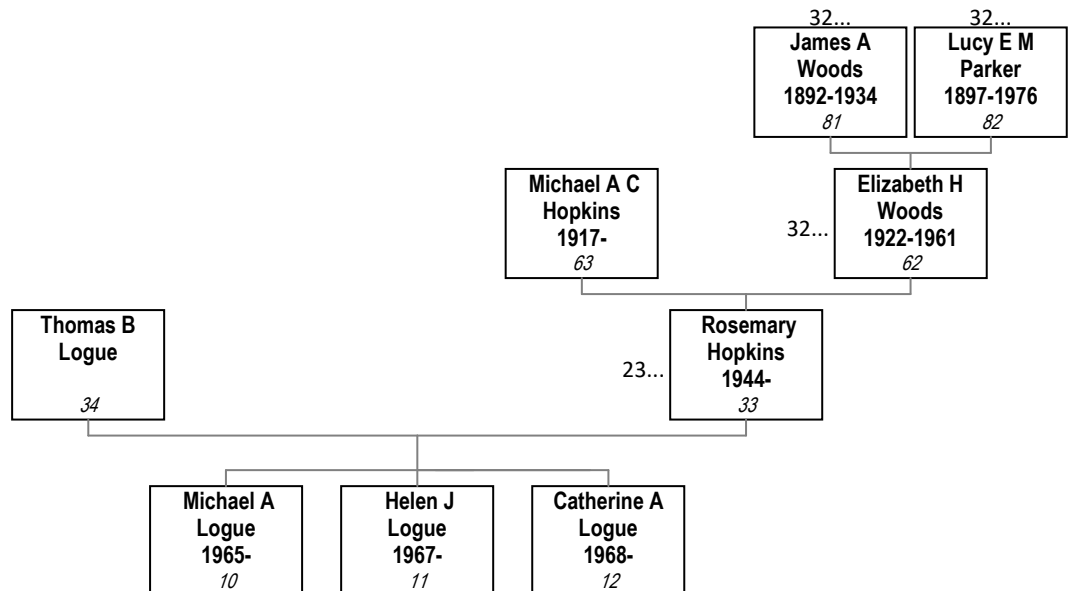

**11. David Taylor and Veronica Ann Cairns**

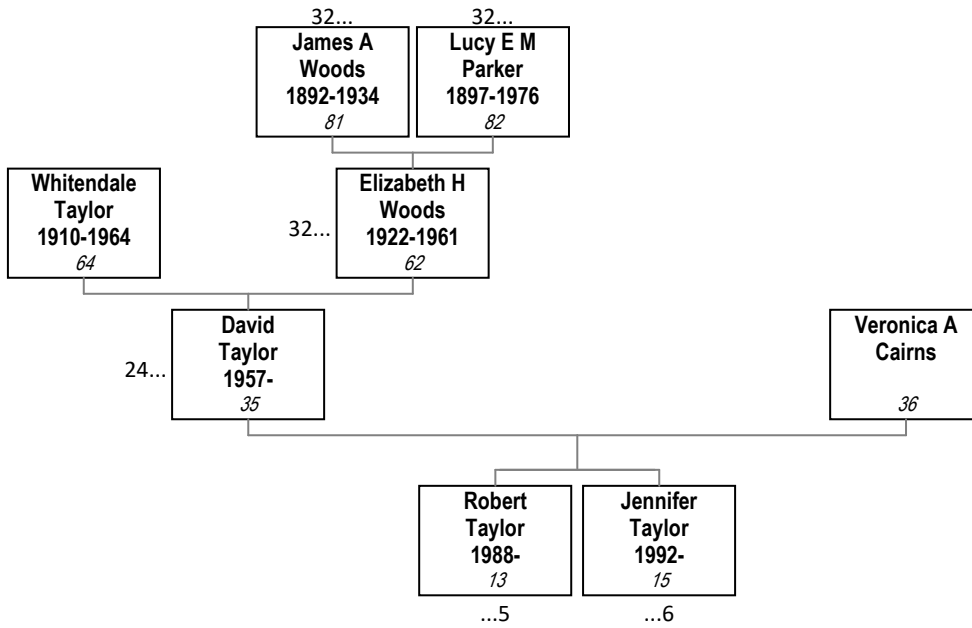

**12. John A Taylor and Margaret M Swarbrick**

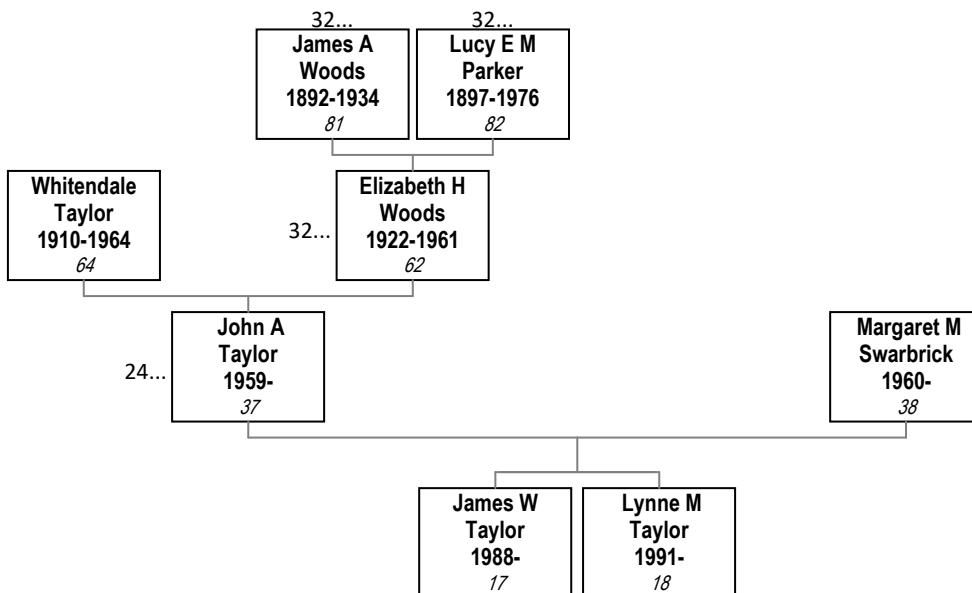

**13. Raymond Lister and Gail Saunders**

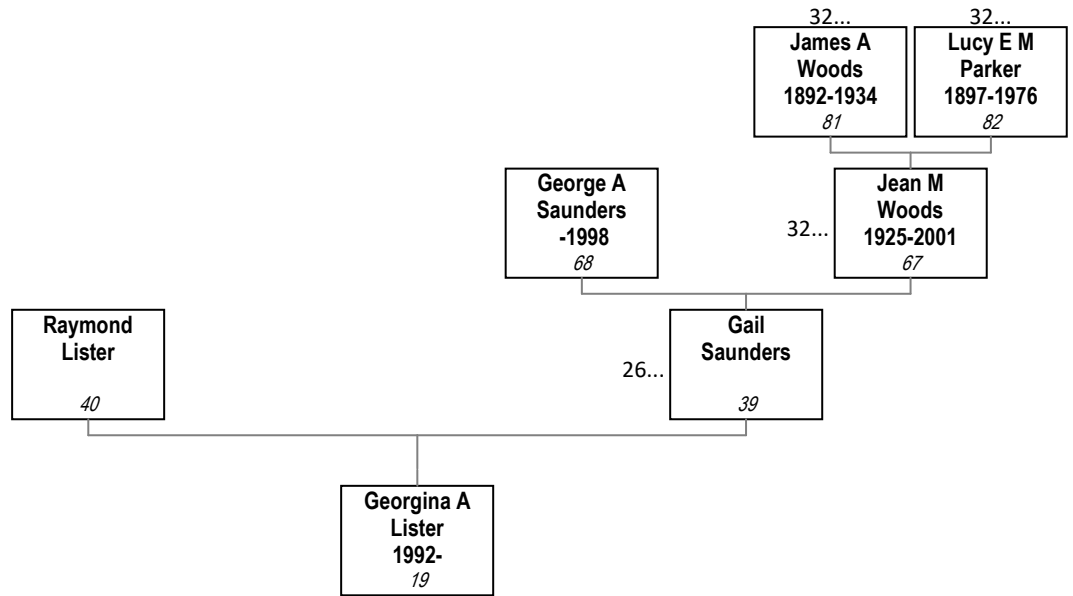

**14. Leonard Stewart Taylor and Gillian Saunders**

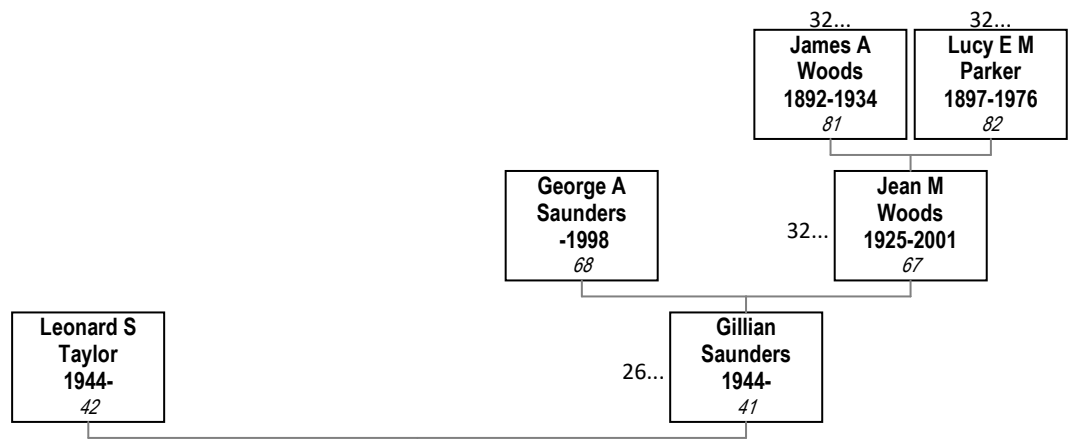

**15. Vincent Unknown and Kathleen Graham**

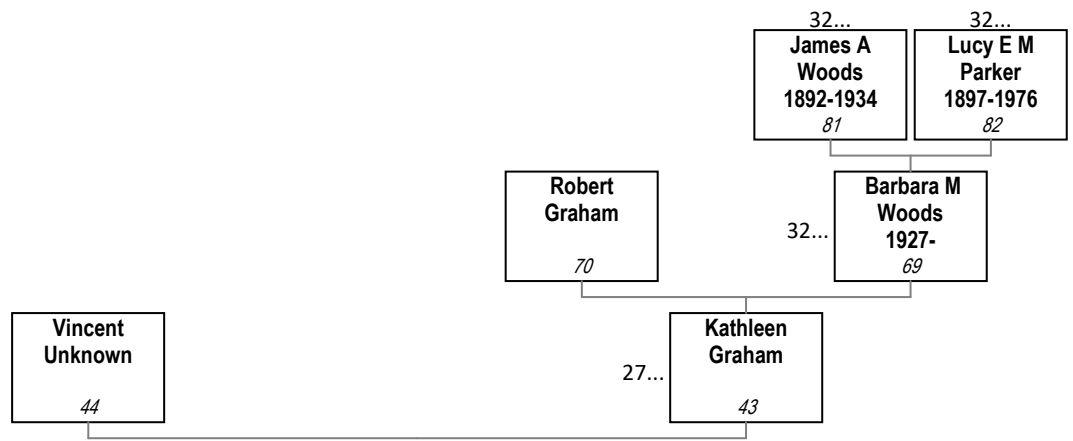

**16. Sean P McDonald and Amanda Helen Woods**

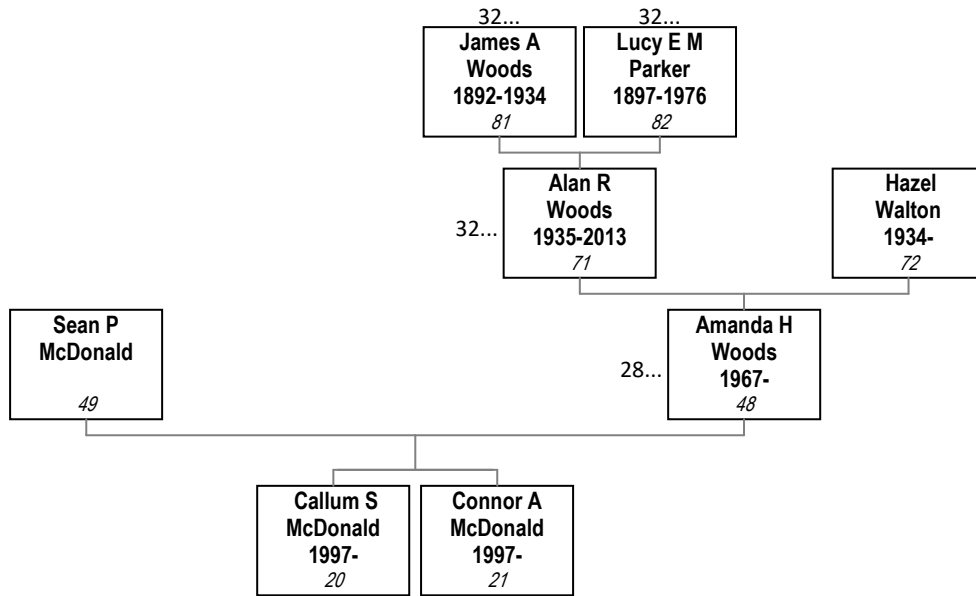

**17. Mr. Hulton and Judy Sopher**

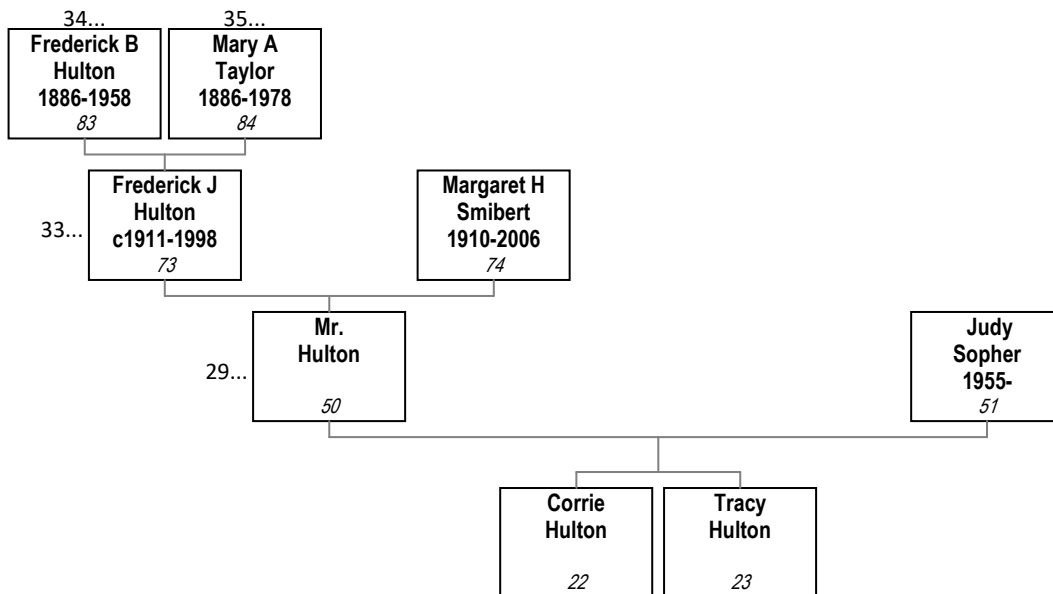

**18. Jack Anderson and Patricia Hulton**

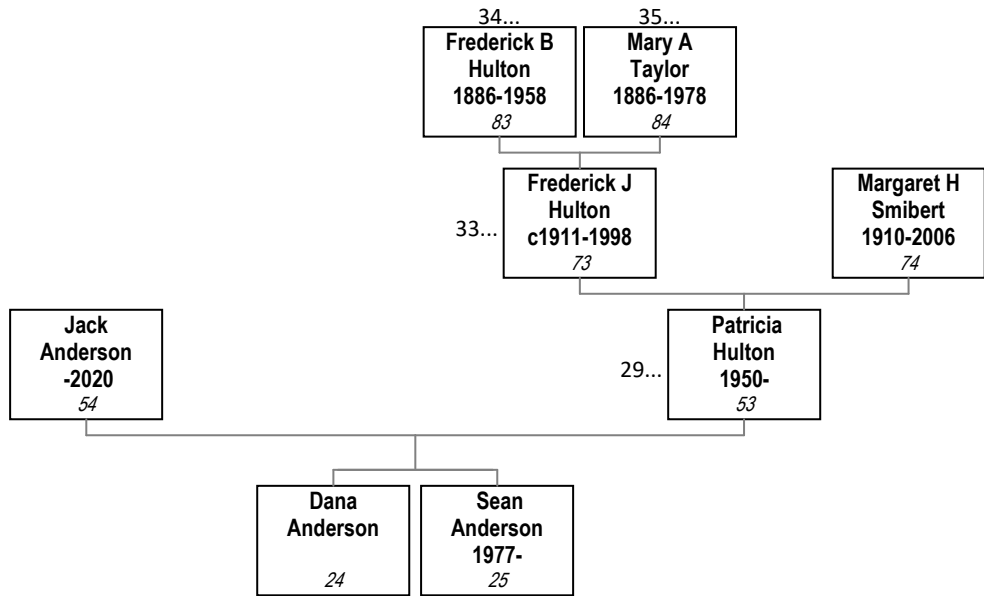

**19. Bruce Labelle and Catherine Gill**

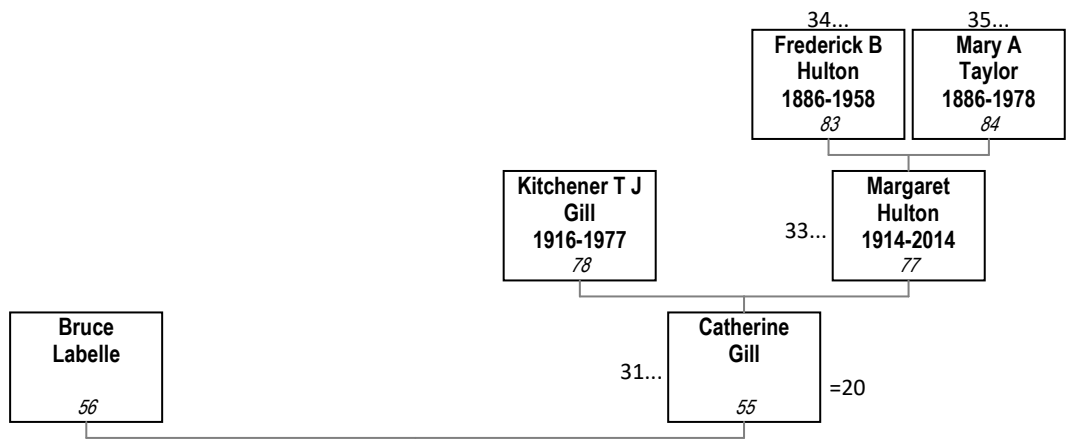

**20. Graham Lewis and Catherine Gill**

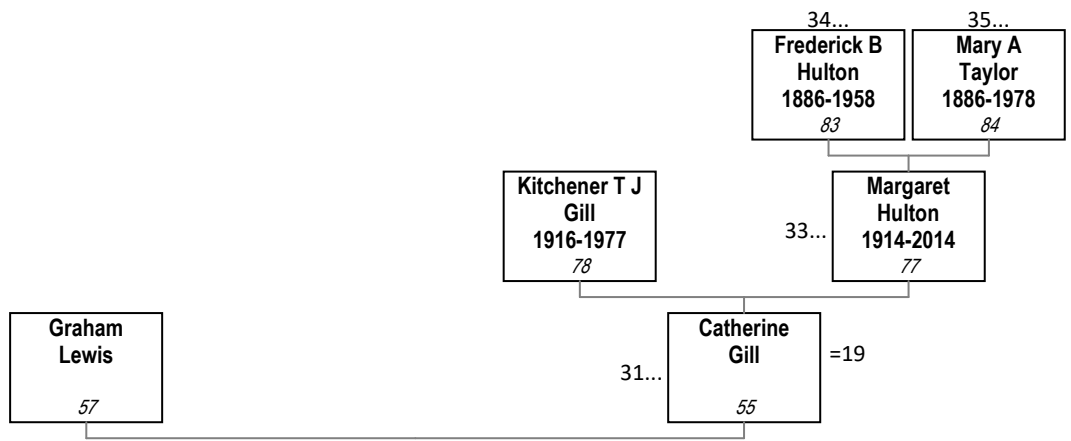

**21. Brian Joseph Gill and Judith Iris**

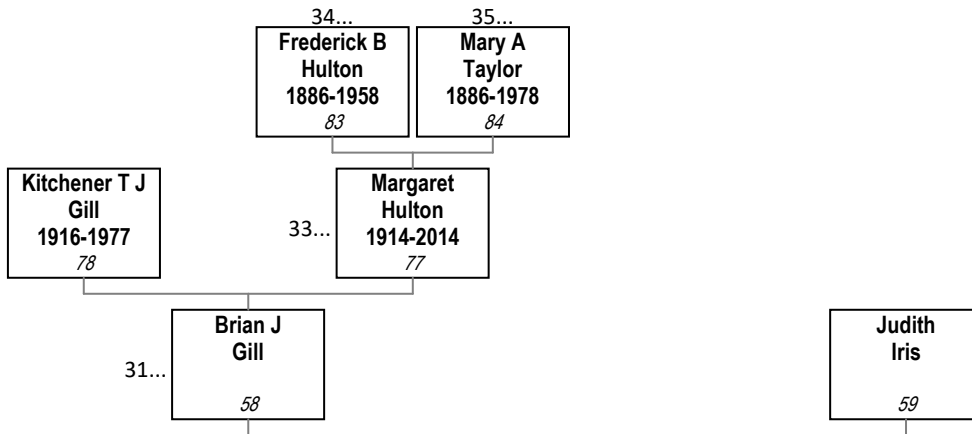

**22. Peter Anthony Woods and Beatrix Marian Hulton**

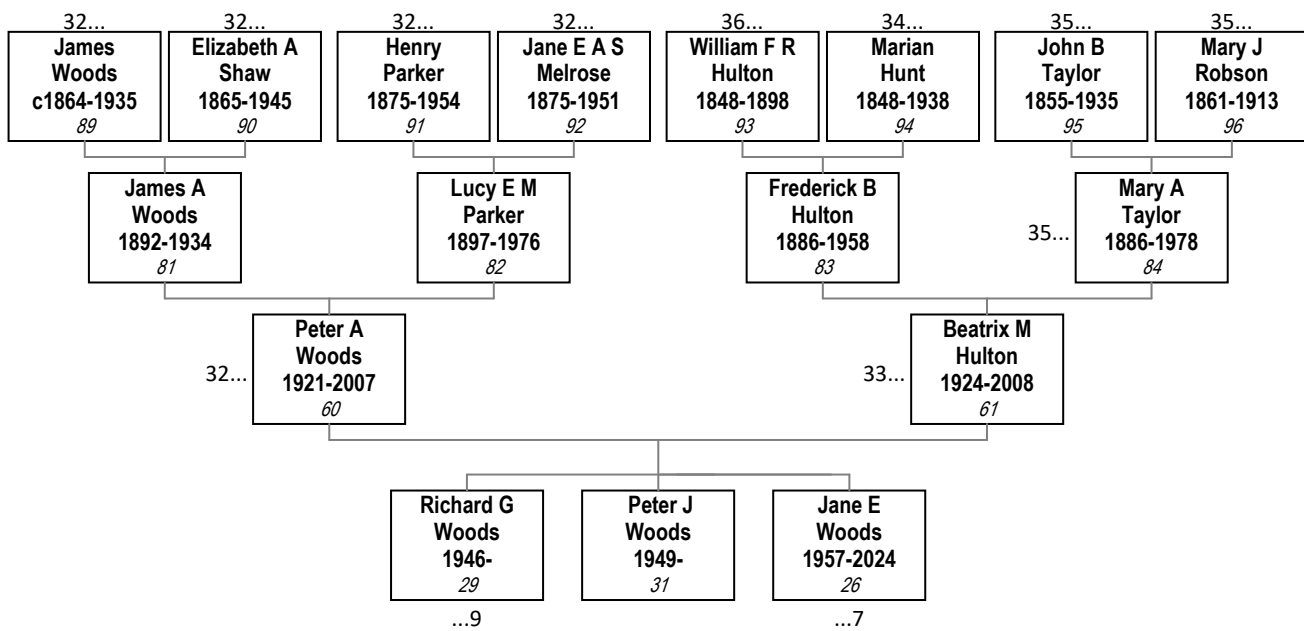

**23. Michael A C Hopkins and Elizabeth Helen Woods**

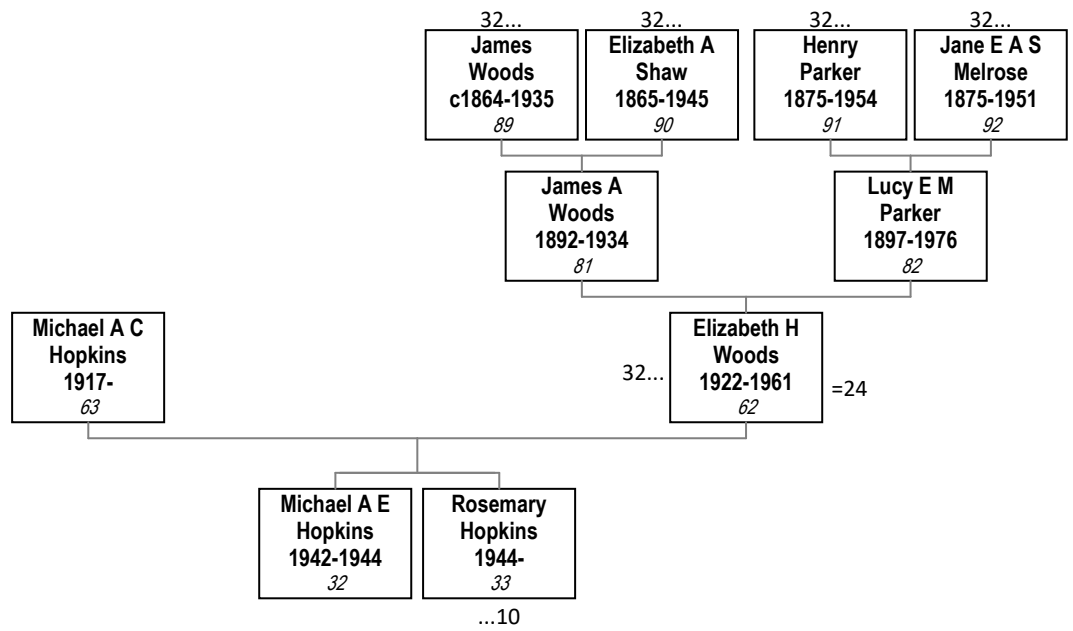

**24. Whitendale Taylor and Elizabeth Helen Woods**

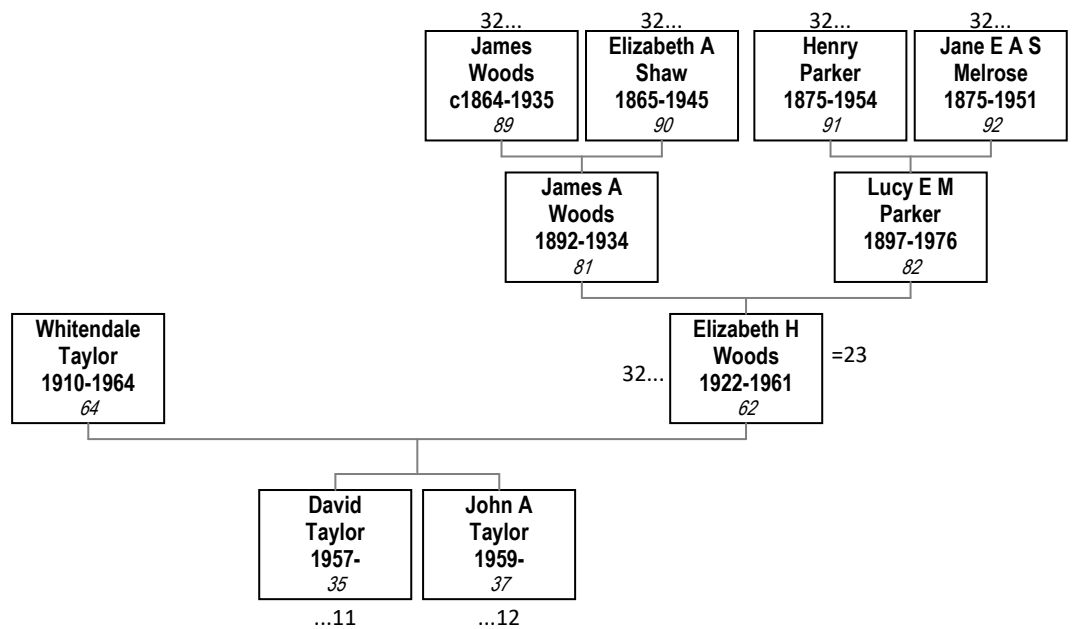

**25. John James Melrose Woods and Mary Price**

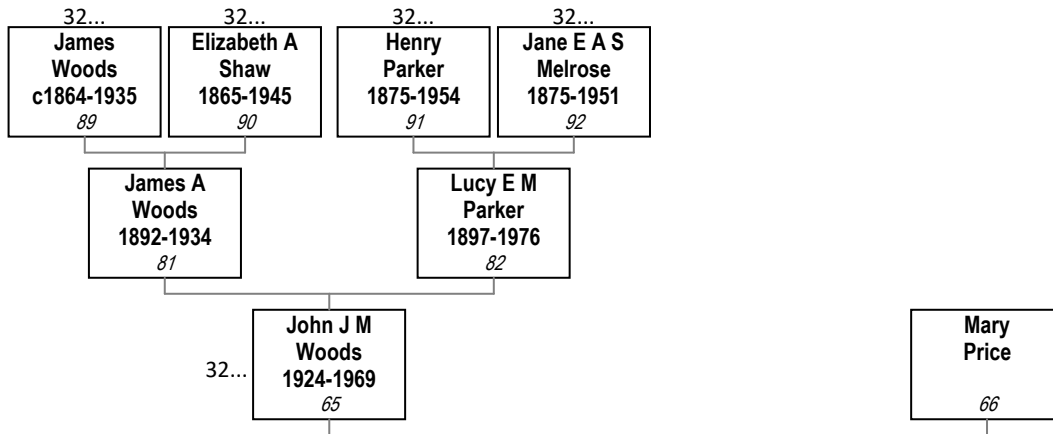

**26. George A Saunders and Jean Margaret Woods**

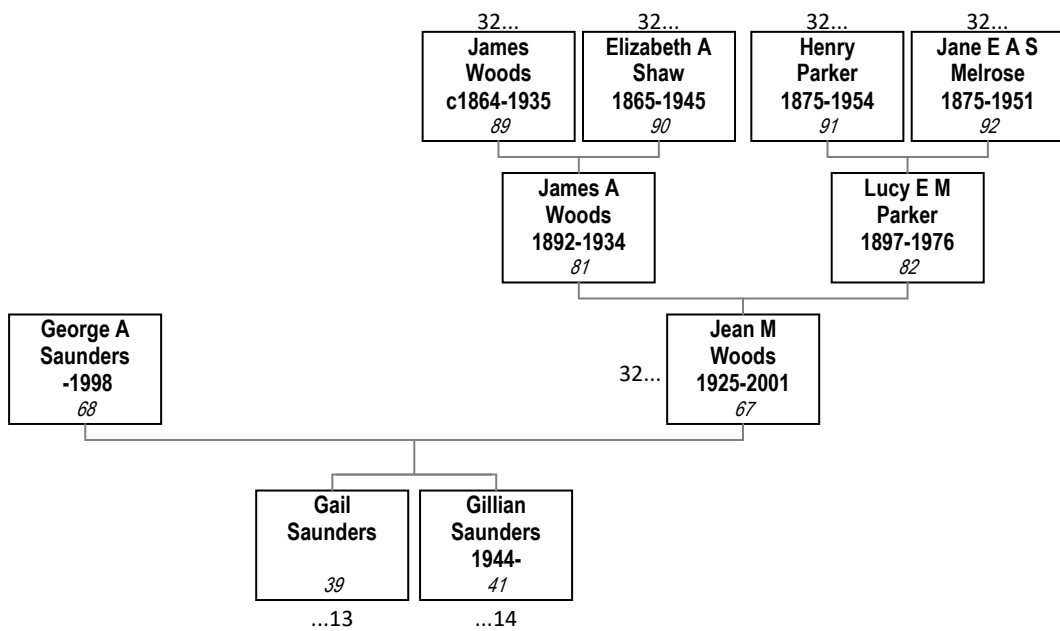

**27. Robert (Roy) J Graham and Barbara M Woods**

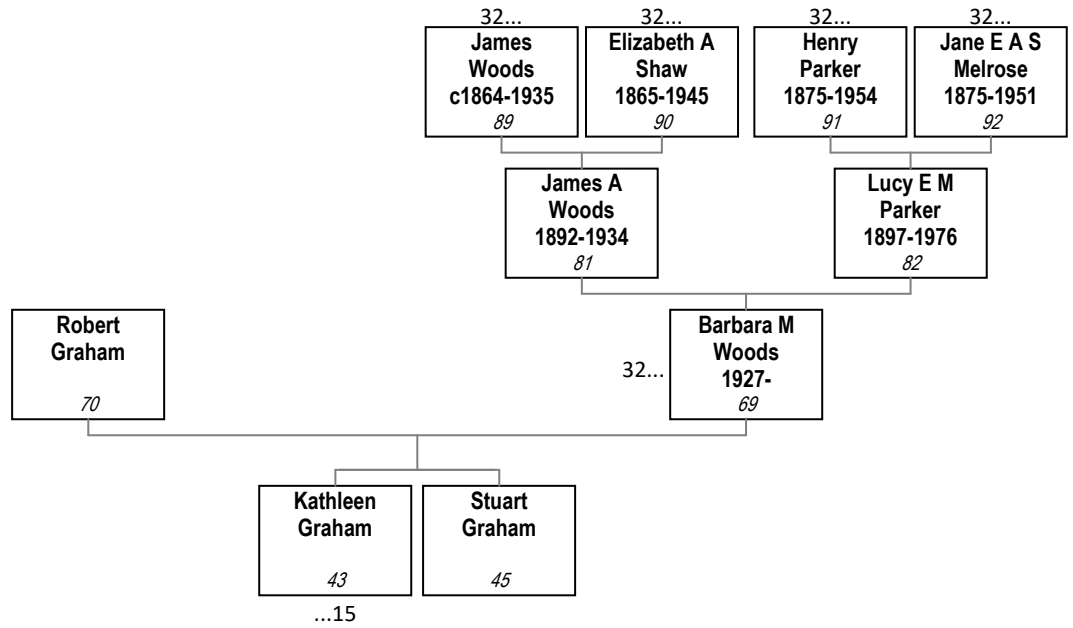

**28. Alan Robert Woods and Hazel Walton**

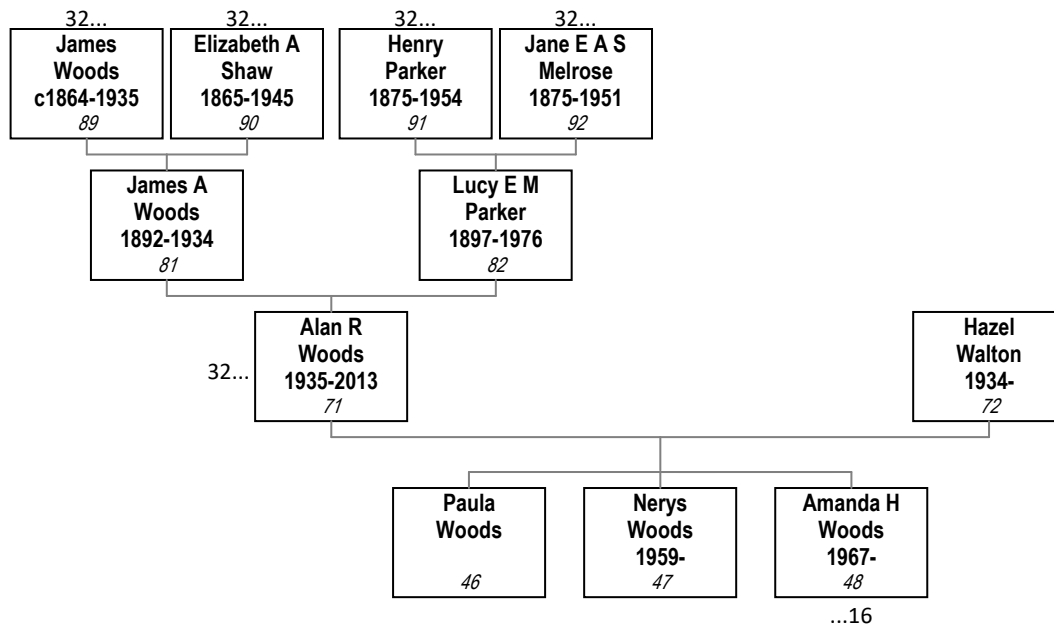

**29. Frederick John Hulton and Margaret Helen Smibert**

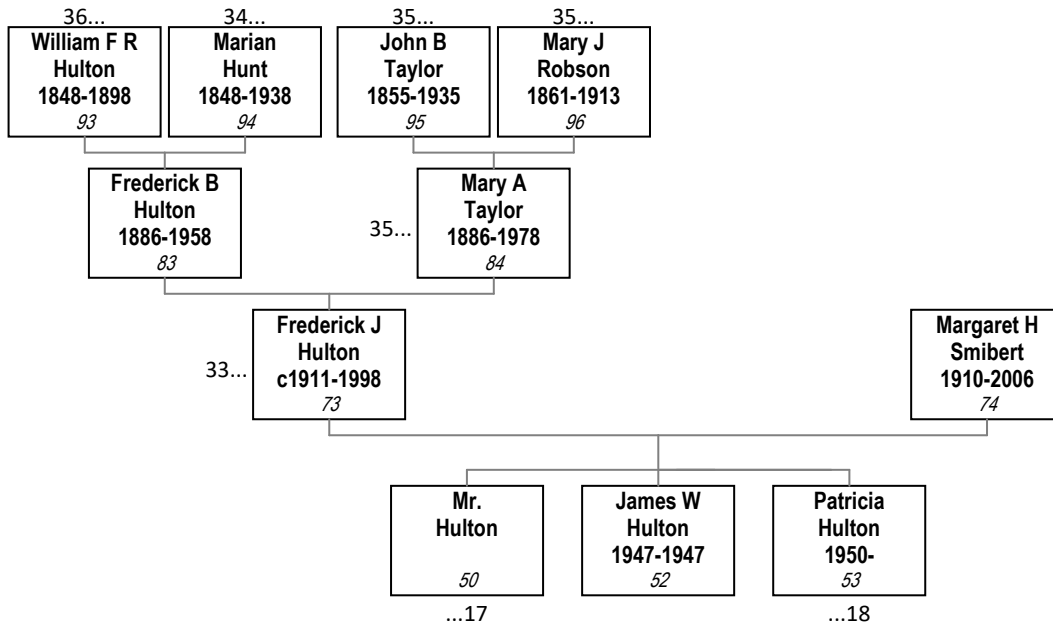

**30. Mr. Boulton and Mary Janet Hulton**

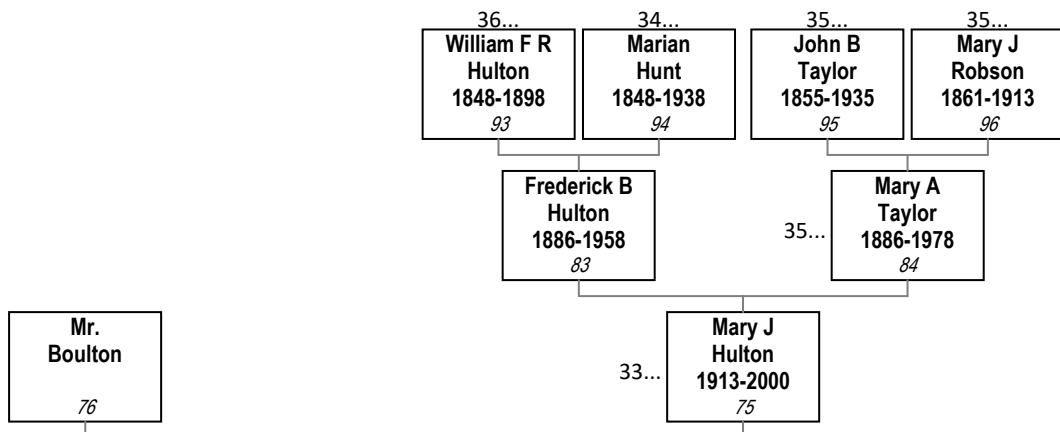

**31. Kitchener Thomas Joseph Gill and Margaret (Meg) Hulton**

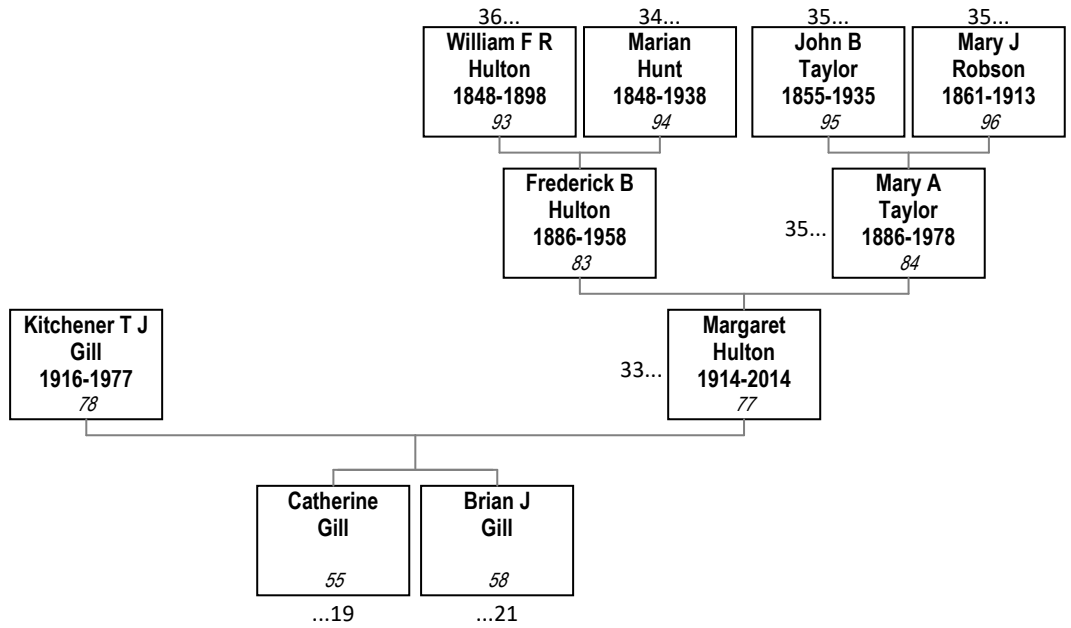

**32. James Anthony Woods and Lucy Ellen Marguerita Parker**

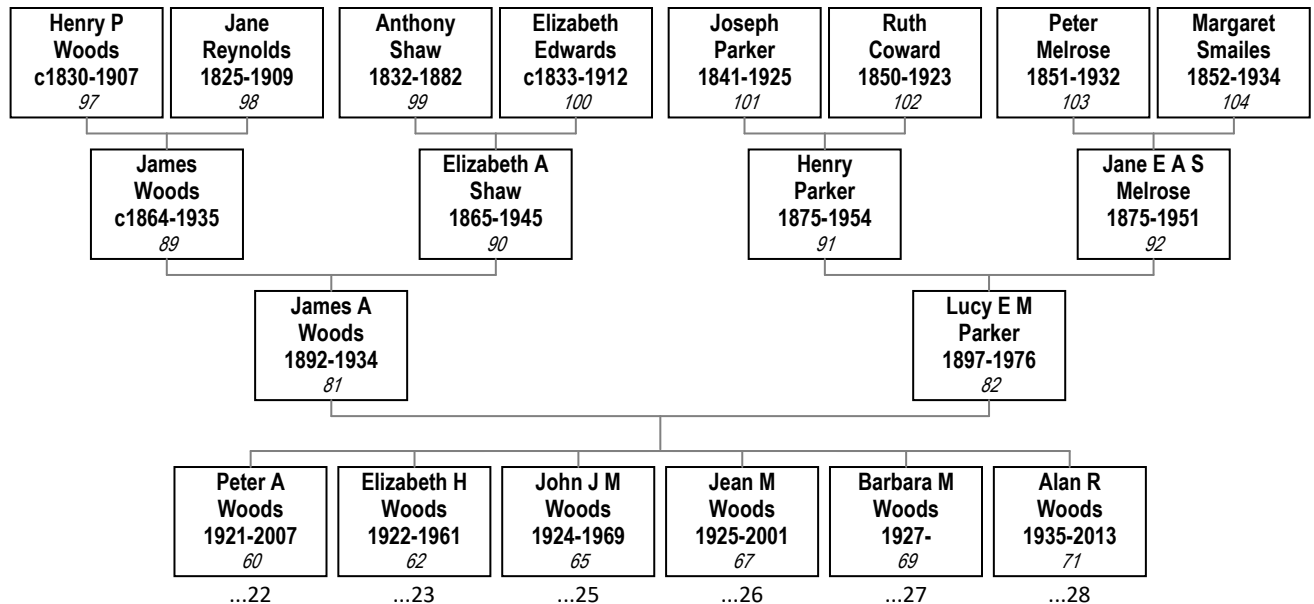

**33. Frederick Blethyn Hulton and Mary Annie Taylor**

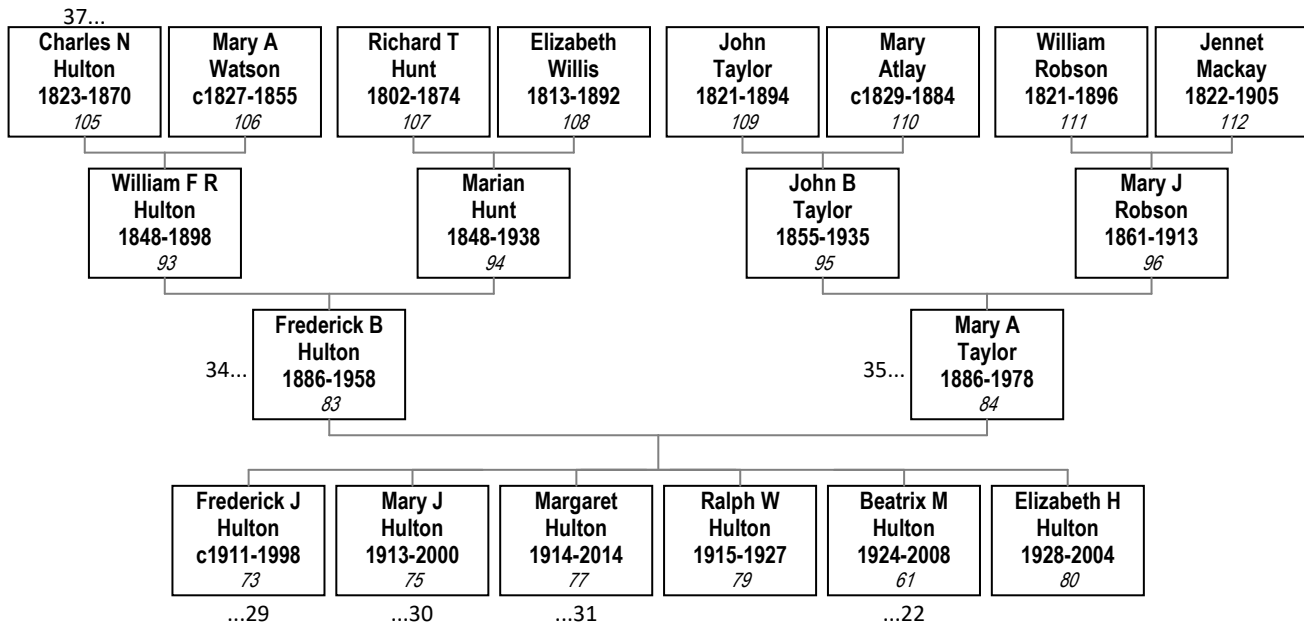

**34. William Ford Ralph Hulton and Marian Hunt**

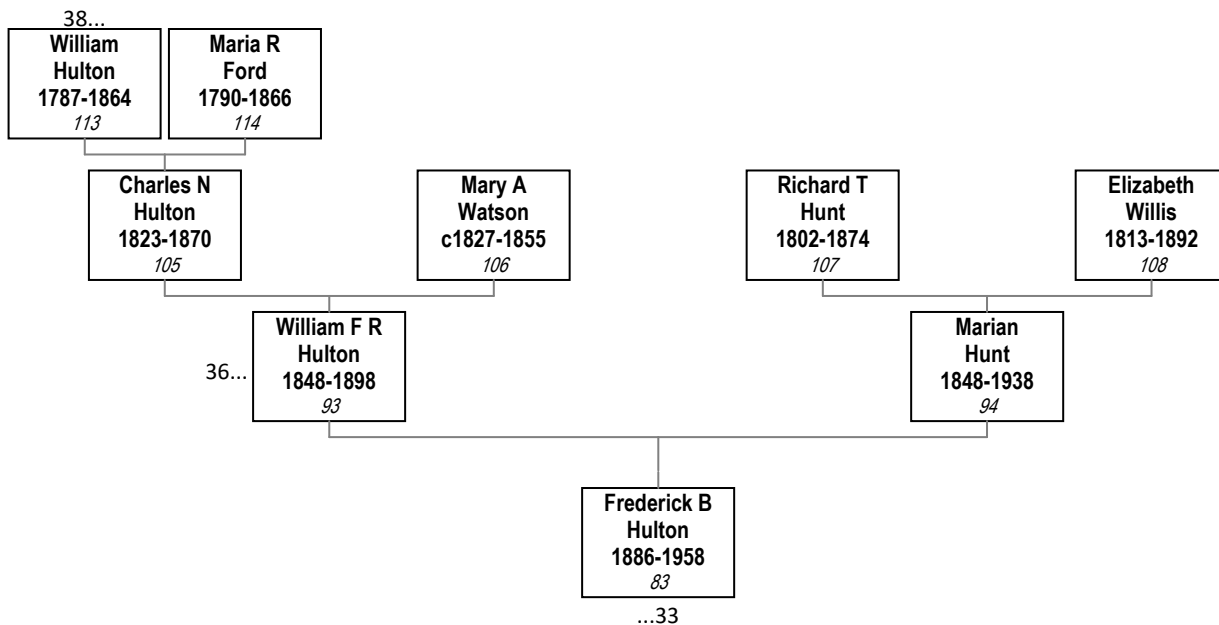

**35. John Benjamin Taylor and Mary Jennet Robson**

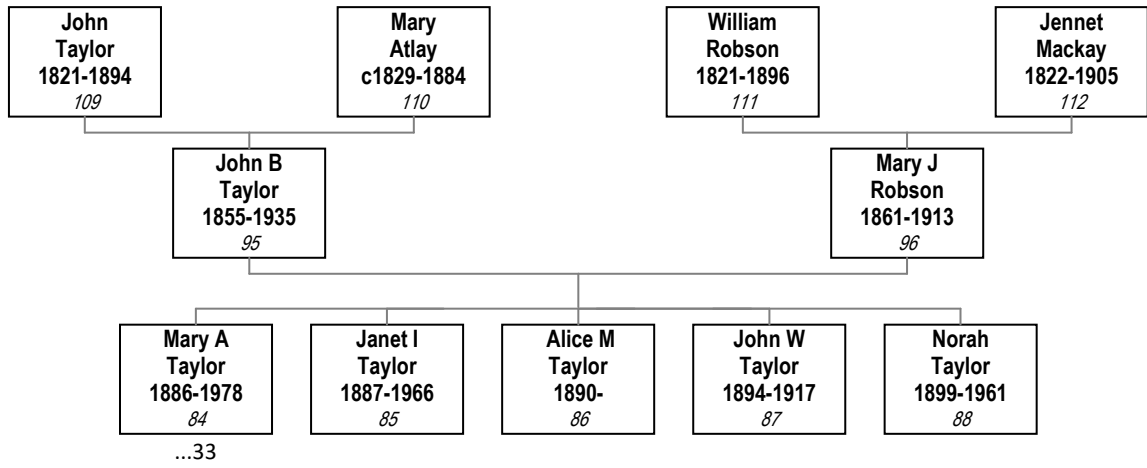

**36. Charles Norleigh Hulton and Mary Ann Watson**

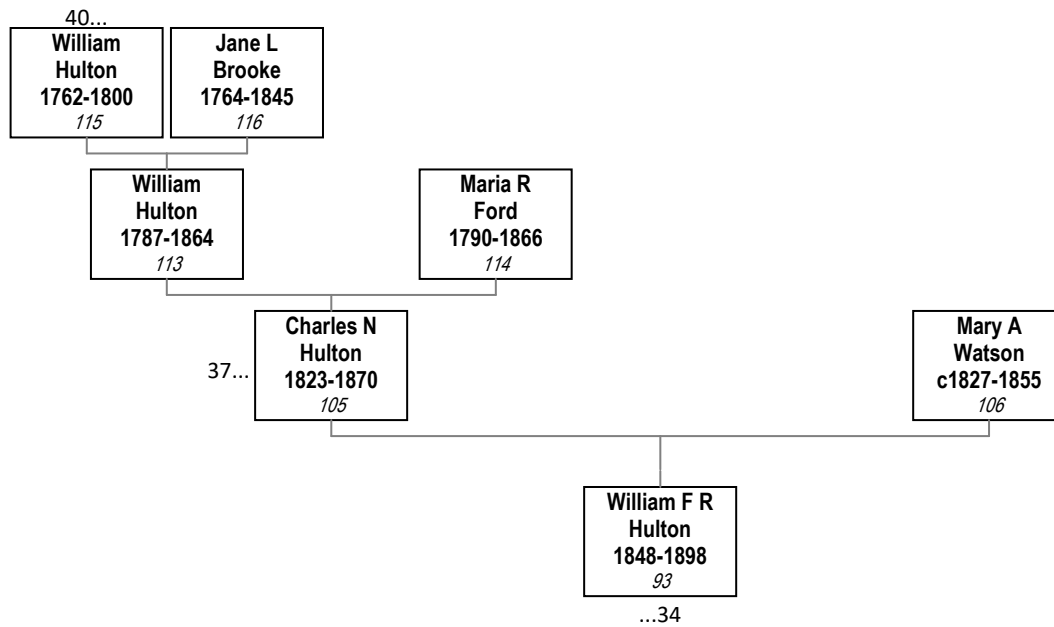

**37. William Hulton and Maria Randle Ford**

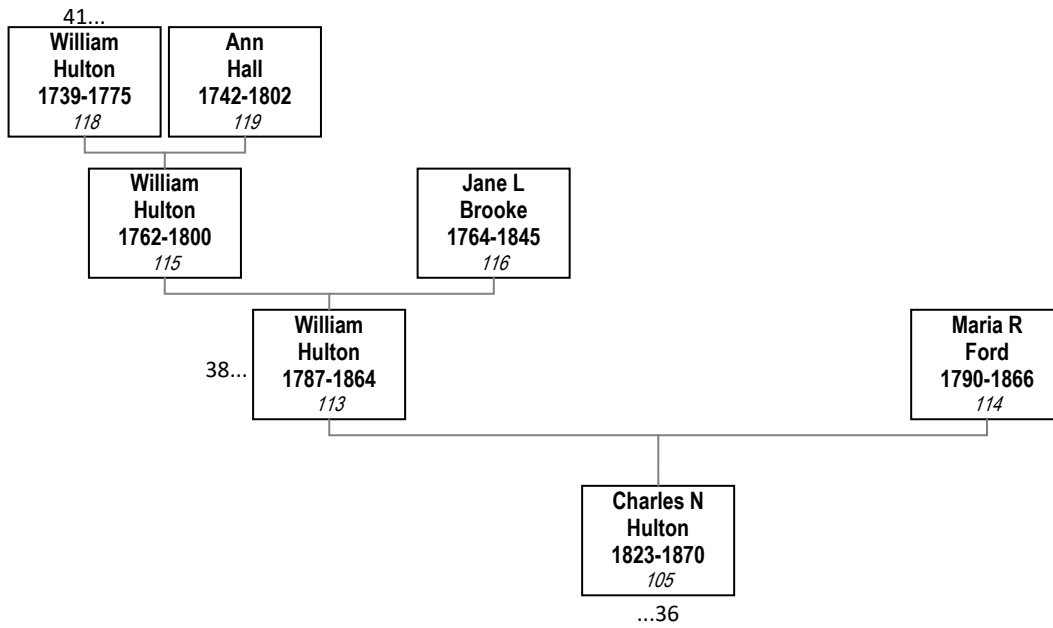

**38. William Hulton and Jane Langford Brooke**

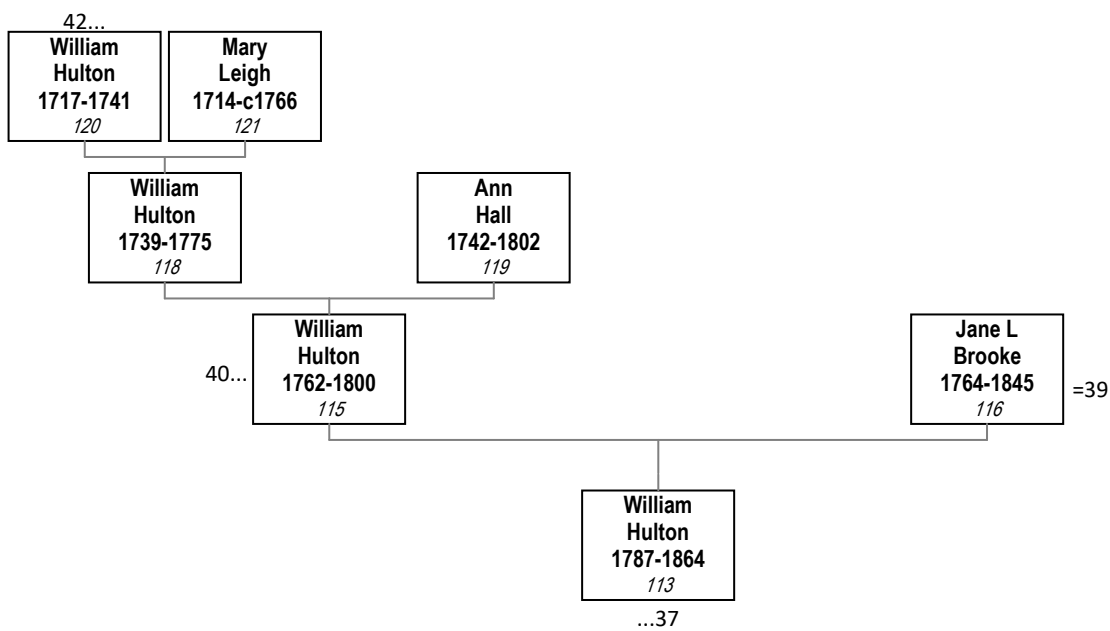

**39. William Tyrrell Boyce and Jane Langford Brooke**



**40. William Hulton and Ann Hall**

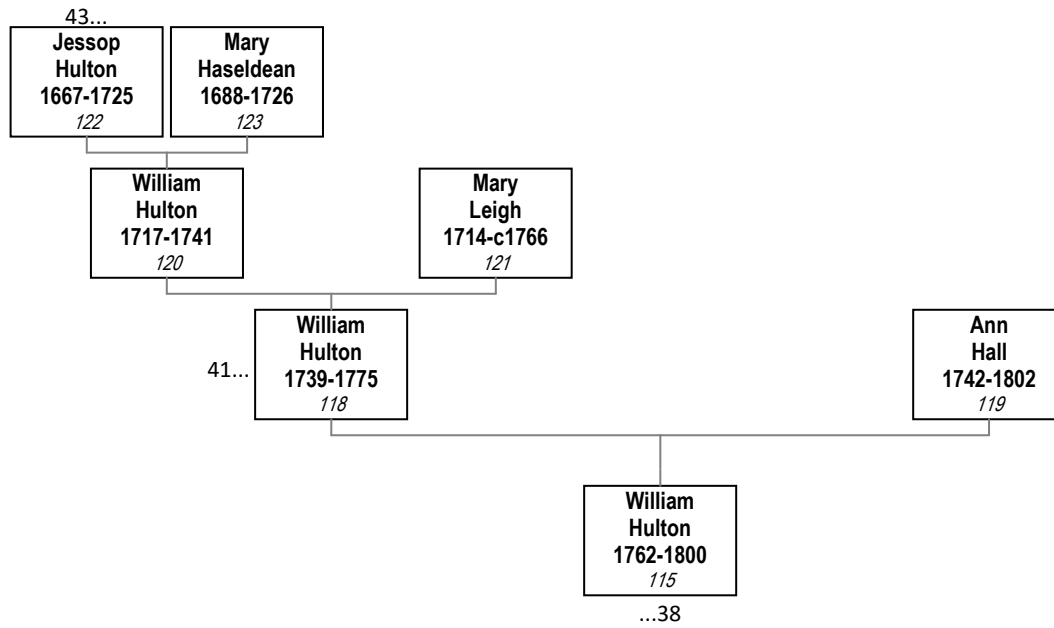

**41. William Hulton and Mary Leigh**

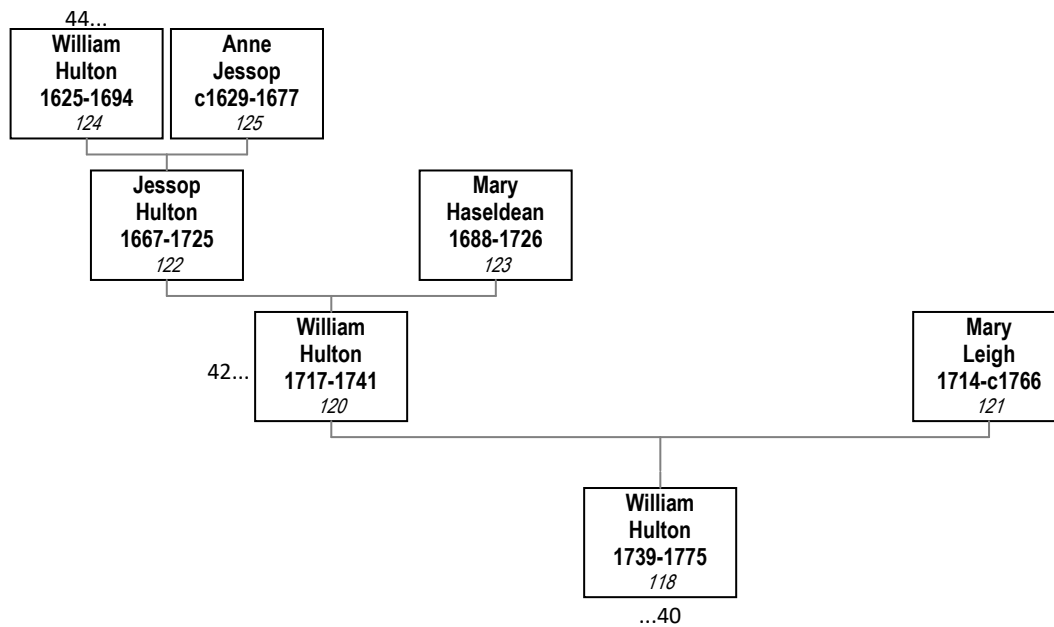

**42. Jessop Hulton and Mary Haseldean**

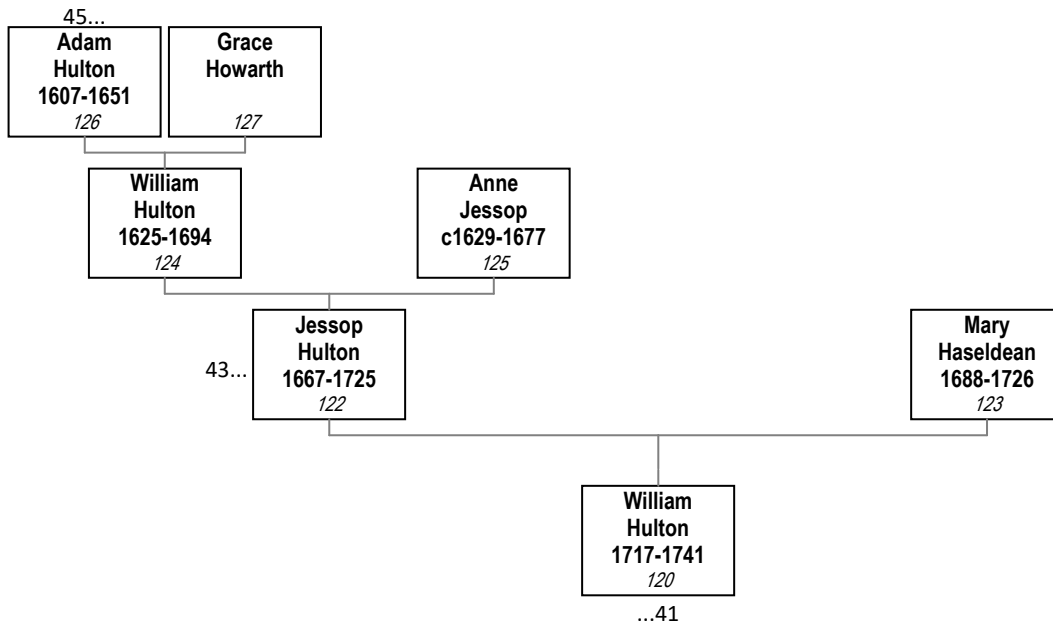

**43. William Hulton and Anne Jessop**

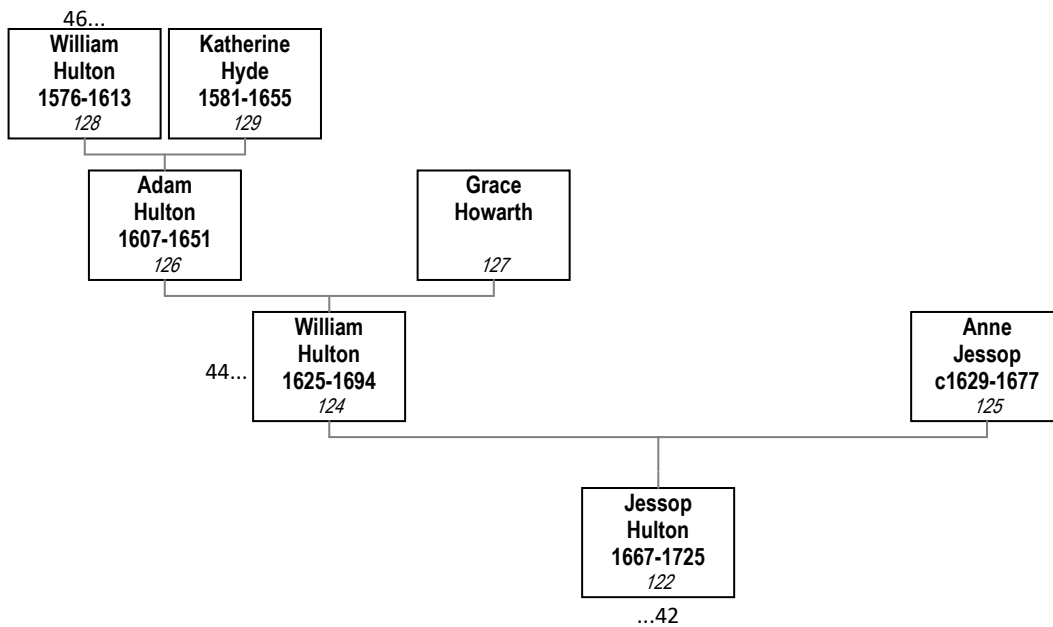

**44. Adam Hulton and Grace Howarth**

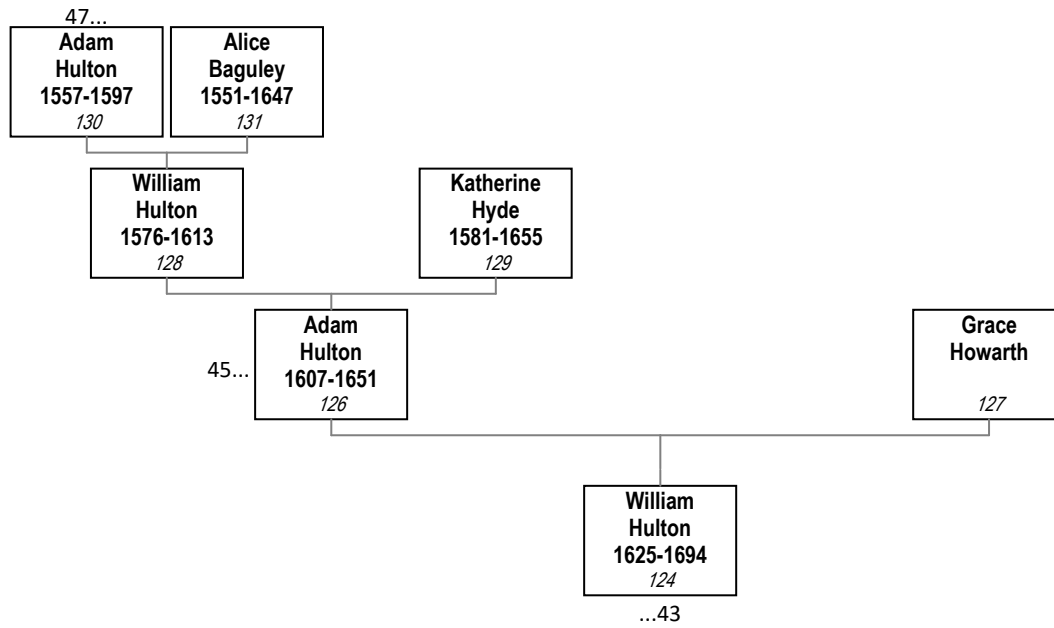

**45. William Hulton and Katherine Hyde**

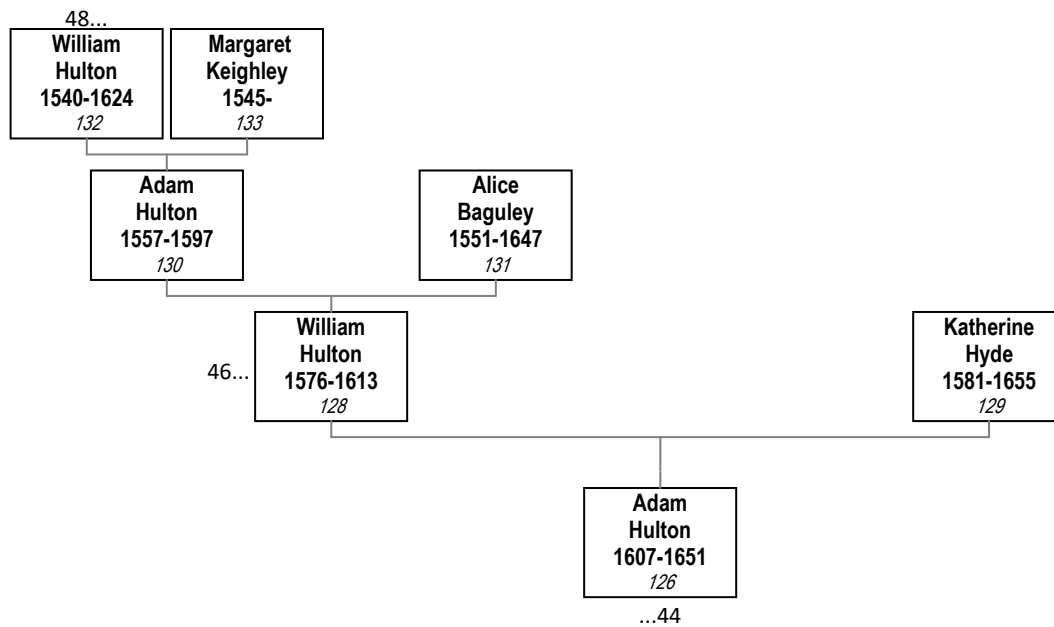

**46. Adam Hulton and Alice Baguley**

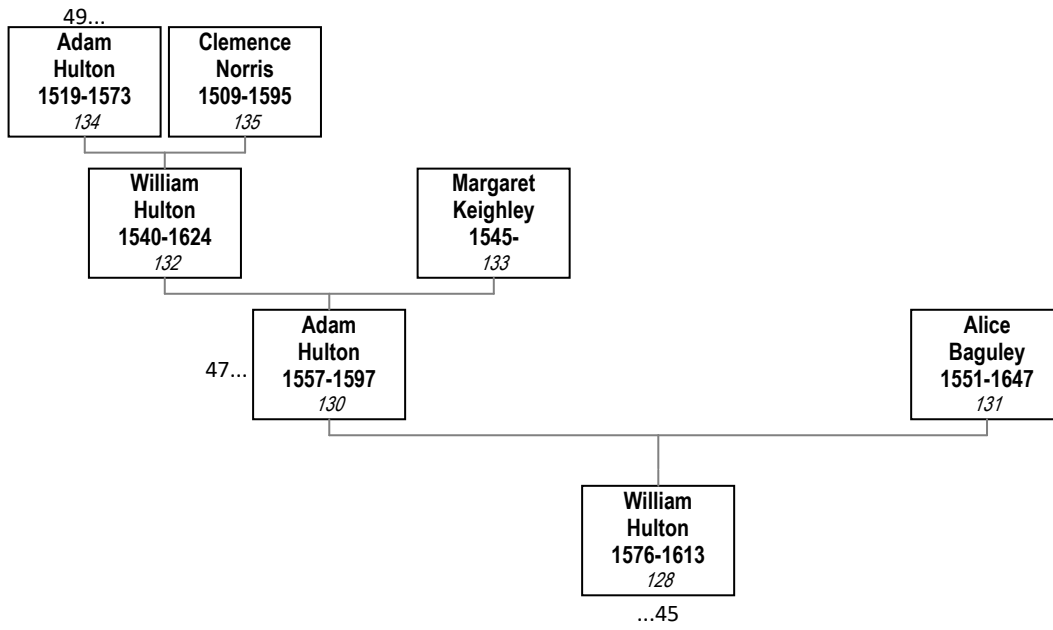

**47. William (The Patriarch) Hulton and Margaret Keighley**

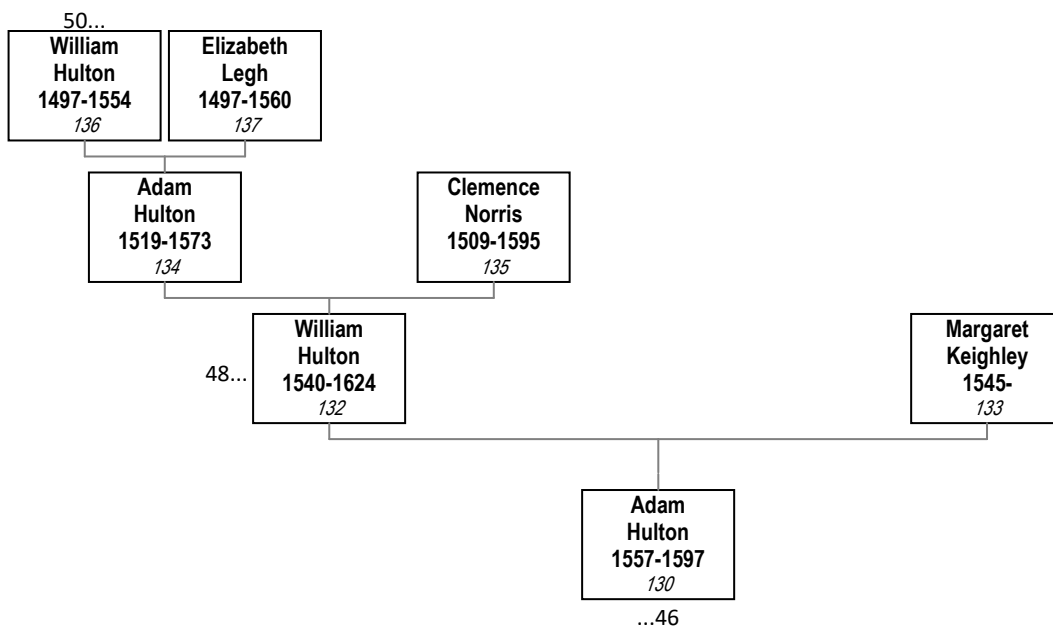

**48. Adam Hulton and Clemence Norris**

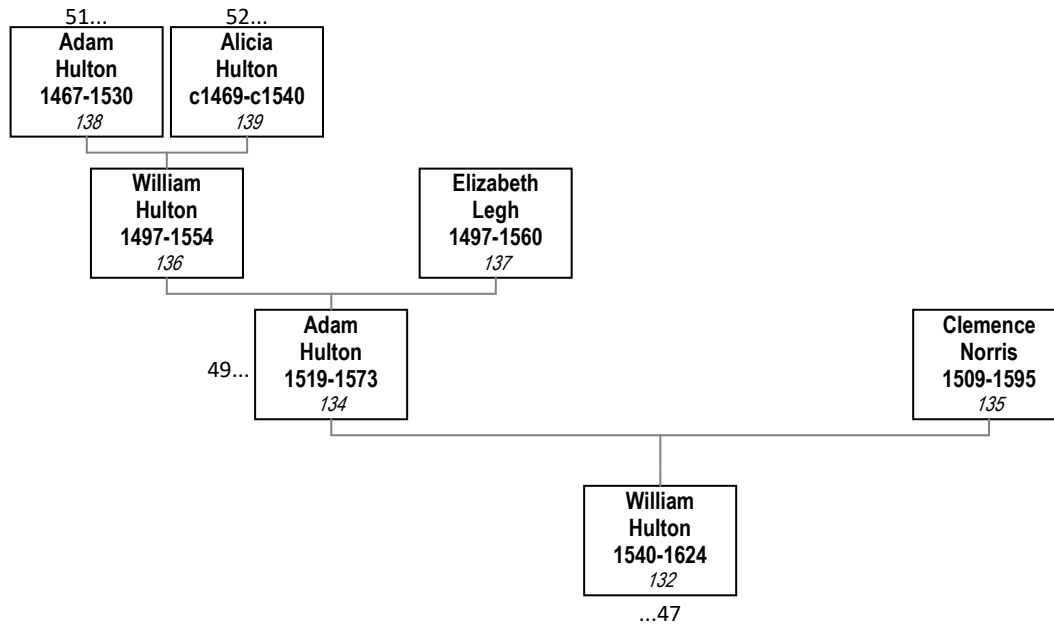

**49. William Hulton and Elizabeth Legh**

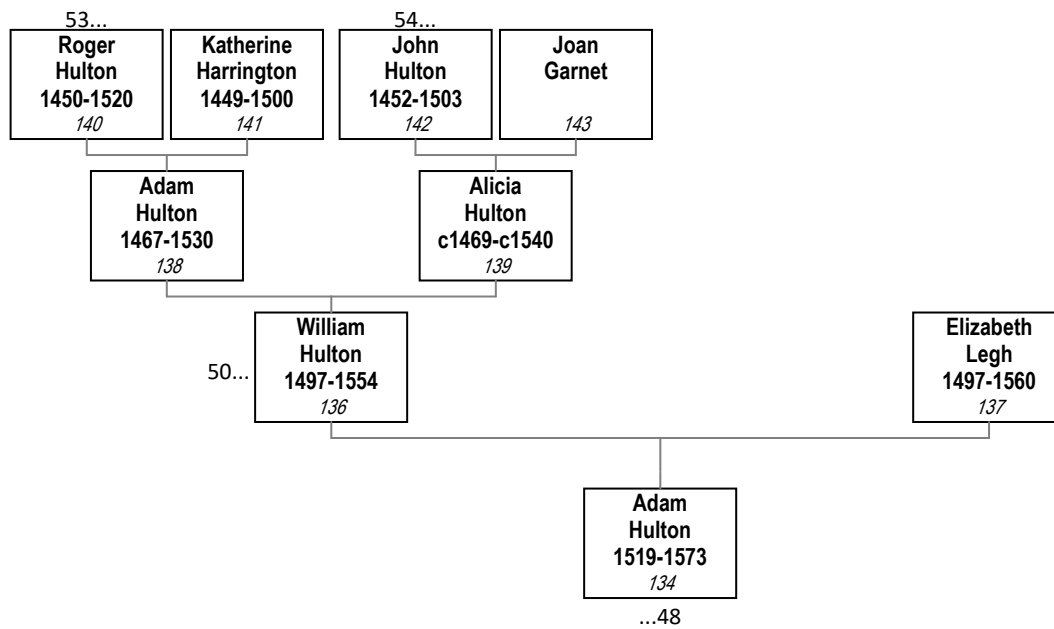

**50. Adam Hulton and Alicia Hulton**

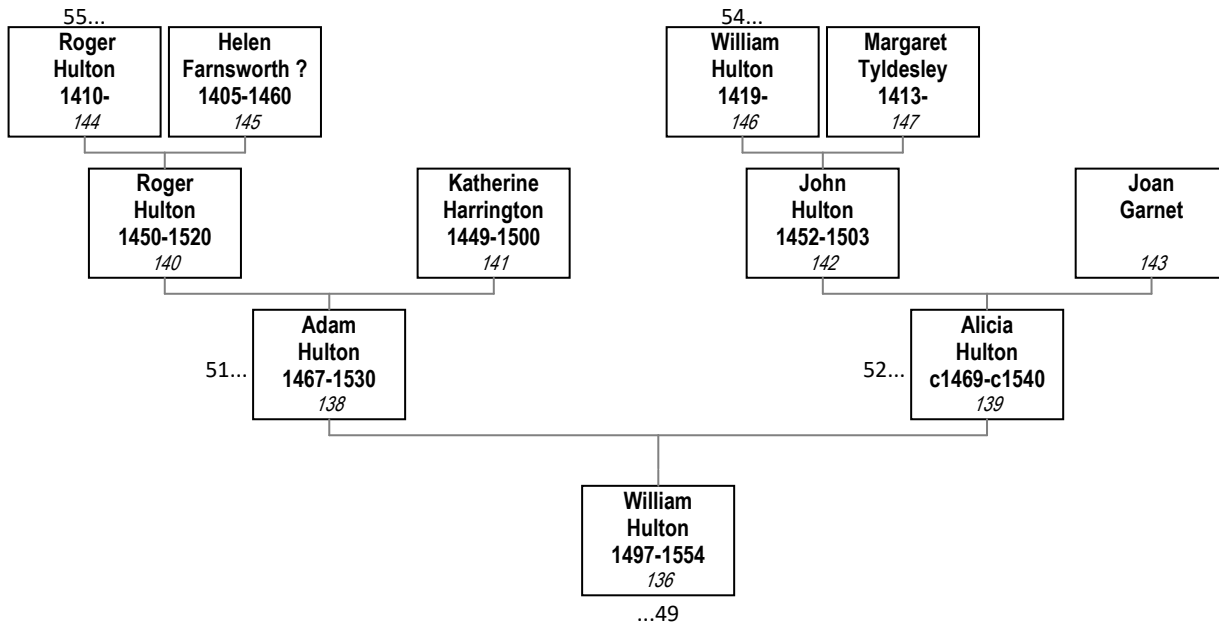

**51. Roger Hulton and Katherine Harrington**

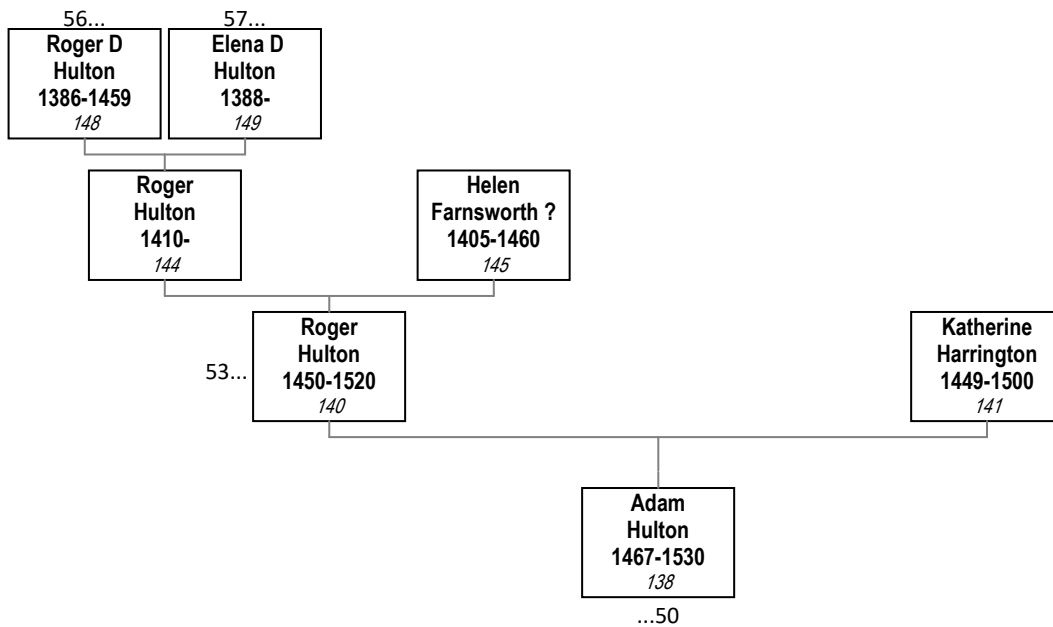

**52. John Hulton and Joan Garnet**

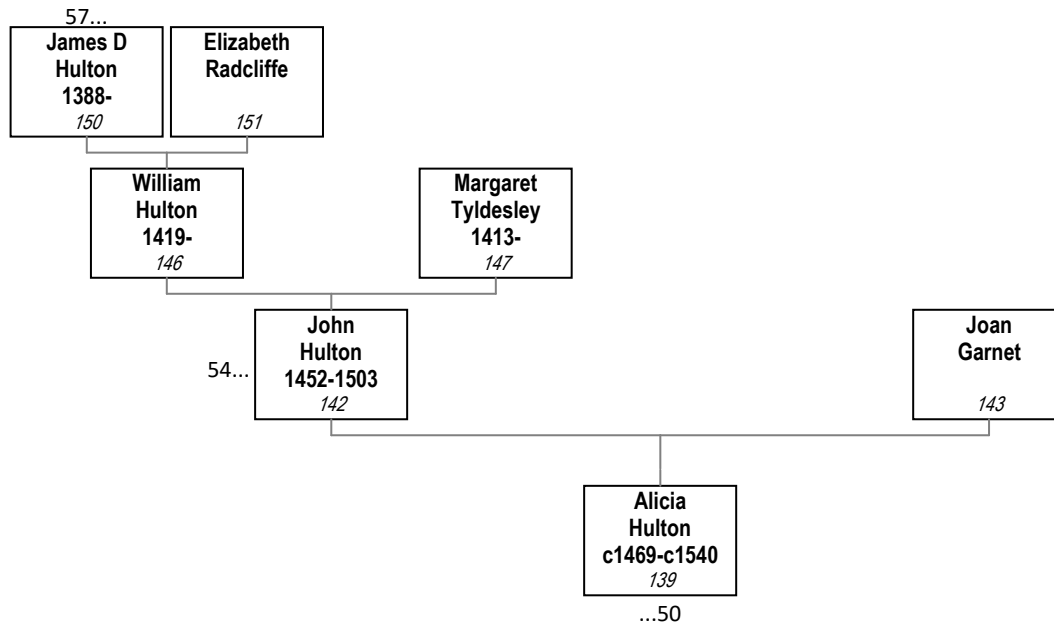

**53. Roger Hulton and Helen Farnsworth ?**

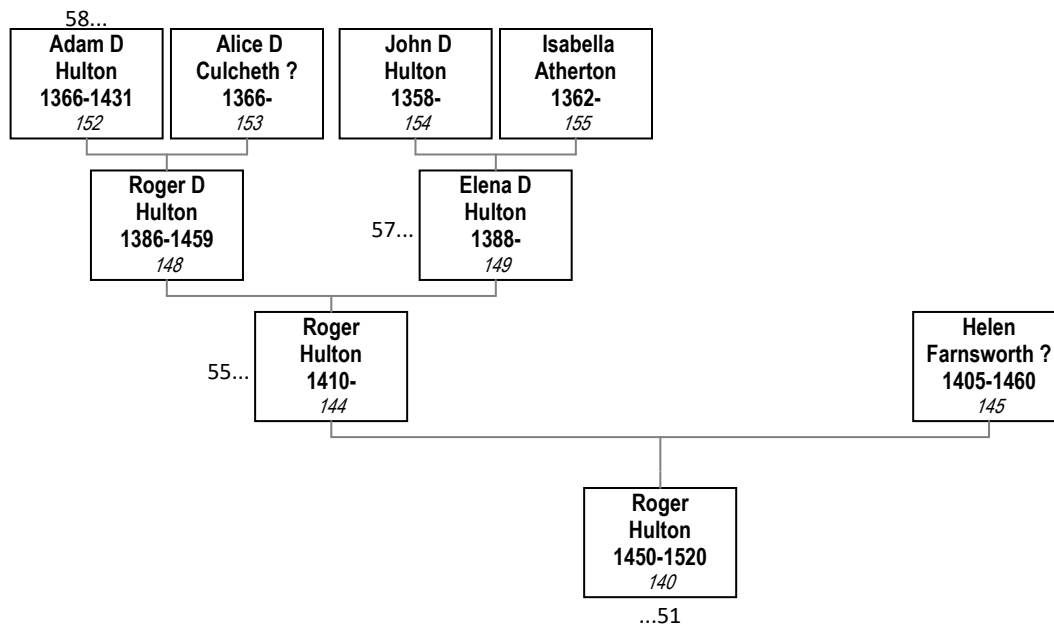

**54. William Hulton and Margaret Tyldesley**

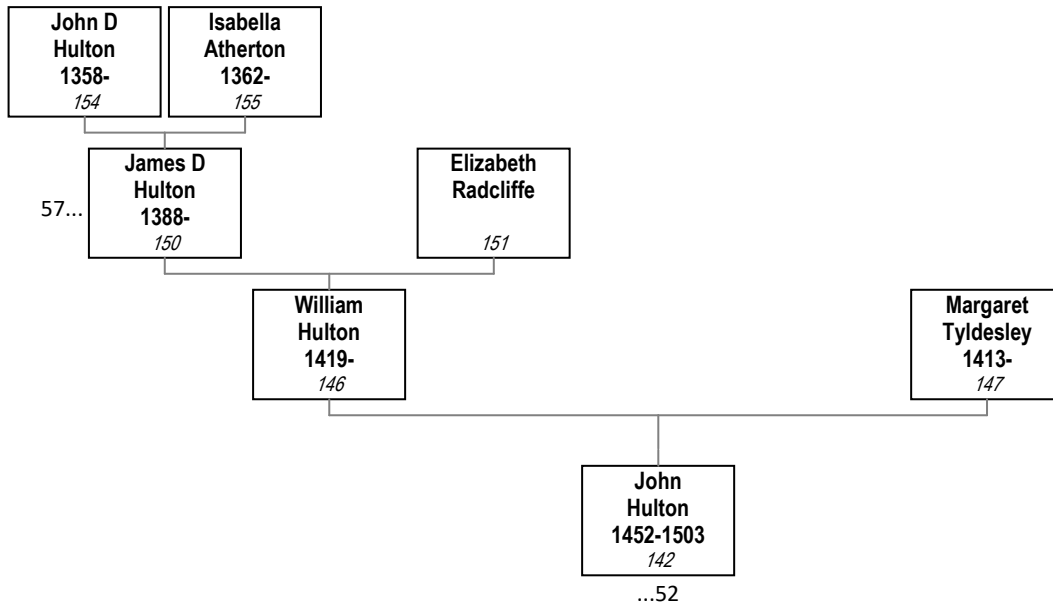

**55. Roger De Hulton and Elena De Hulton**

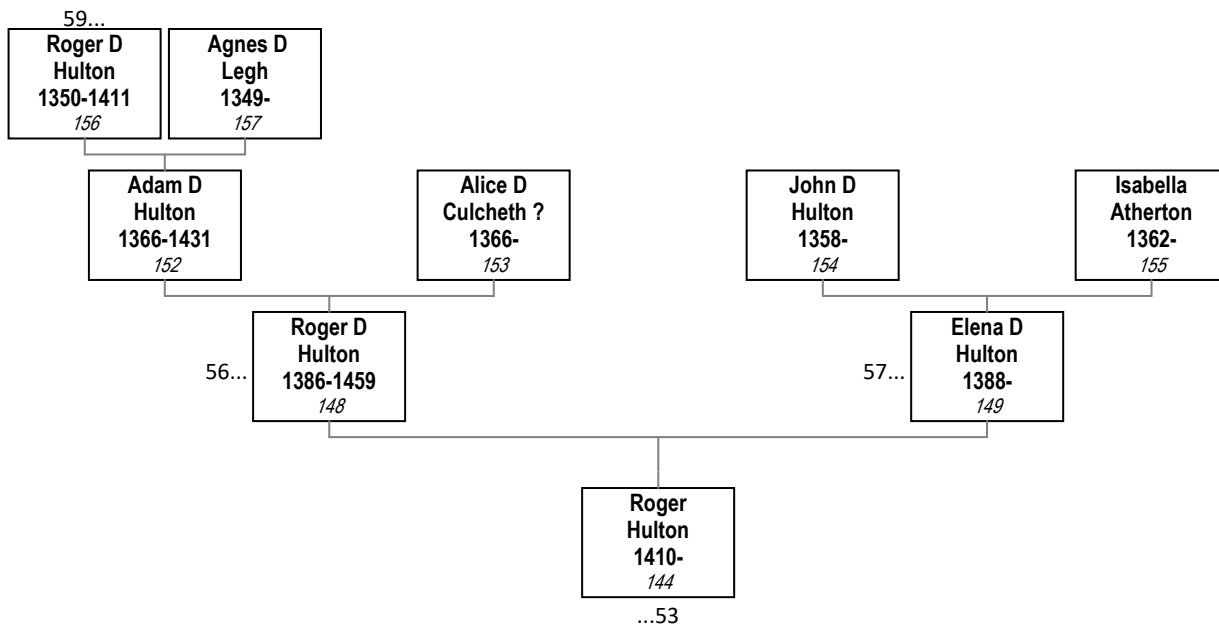

**56. Adam De Hulton and Alice De Culcheth ?**

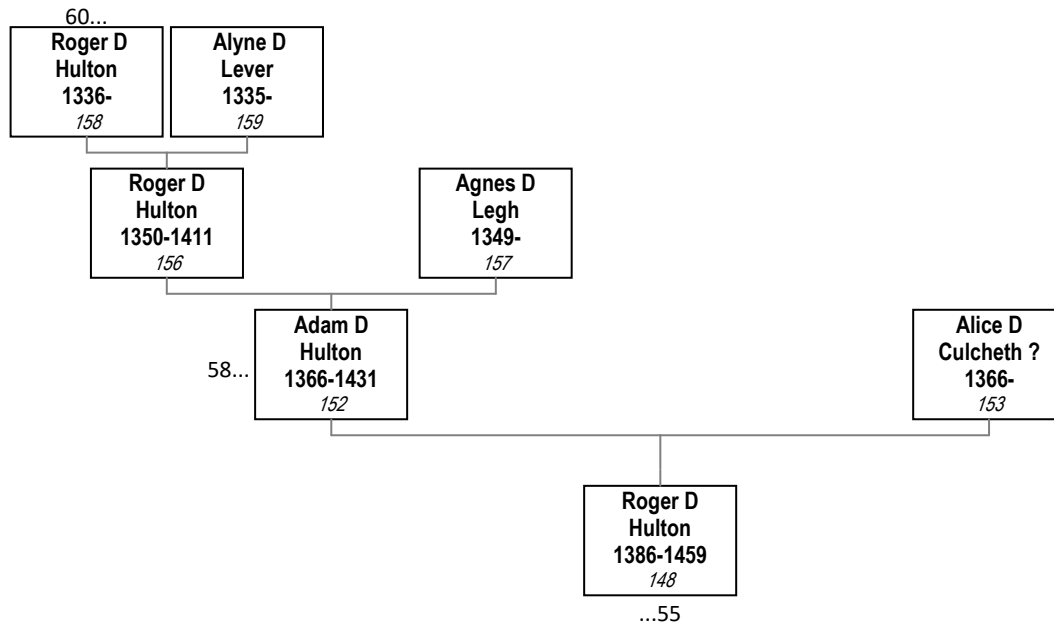

**57. John De Hulton and Isabella Atherton**

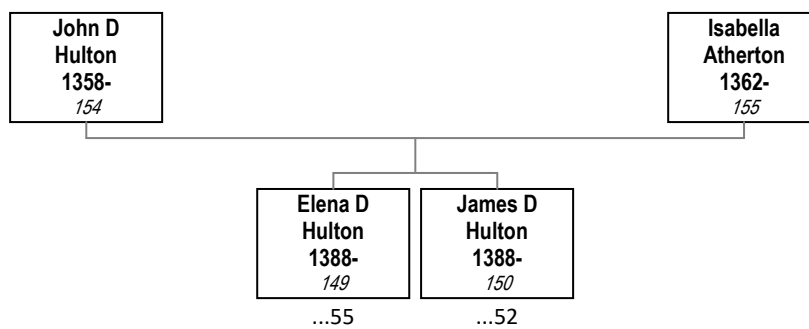

**58. Roger De Hulton and Agnes De Legh**

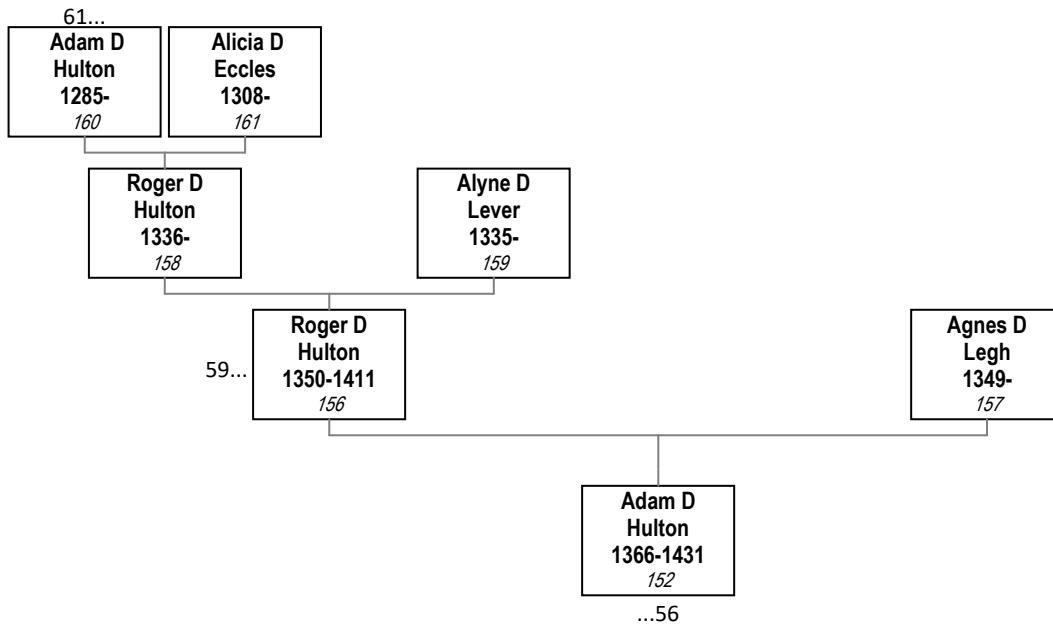

**59. Roger De Hulton and Alyne De Lever**

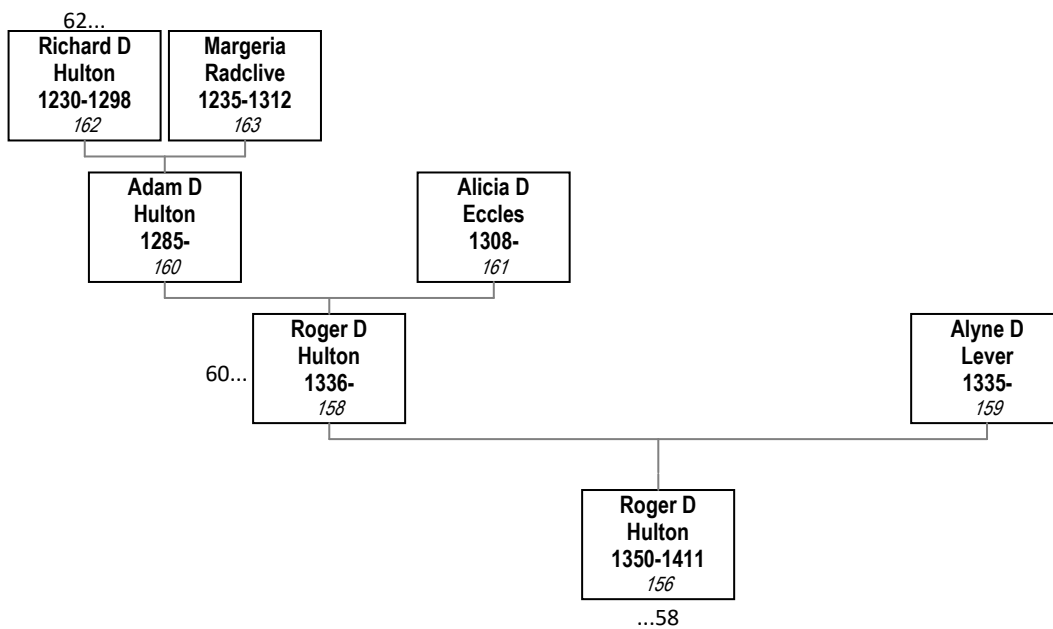

**60. Adam De Hulton and Alicia De Eccles**

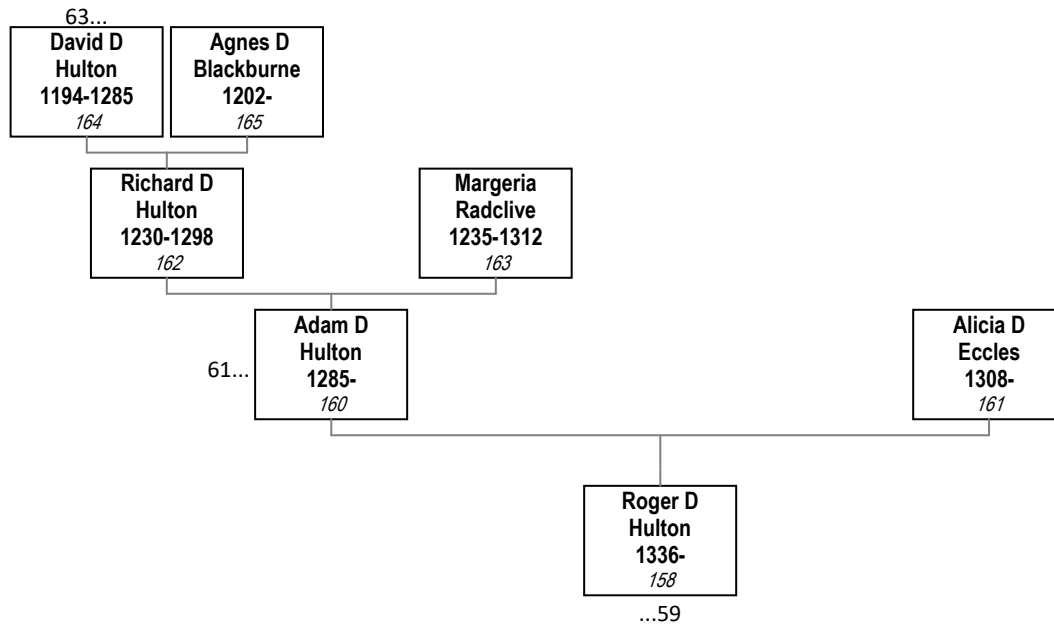

**61. Richard De Hulton and Margeria Radcliffe**

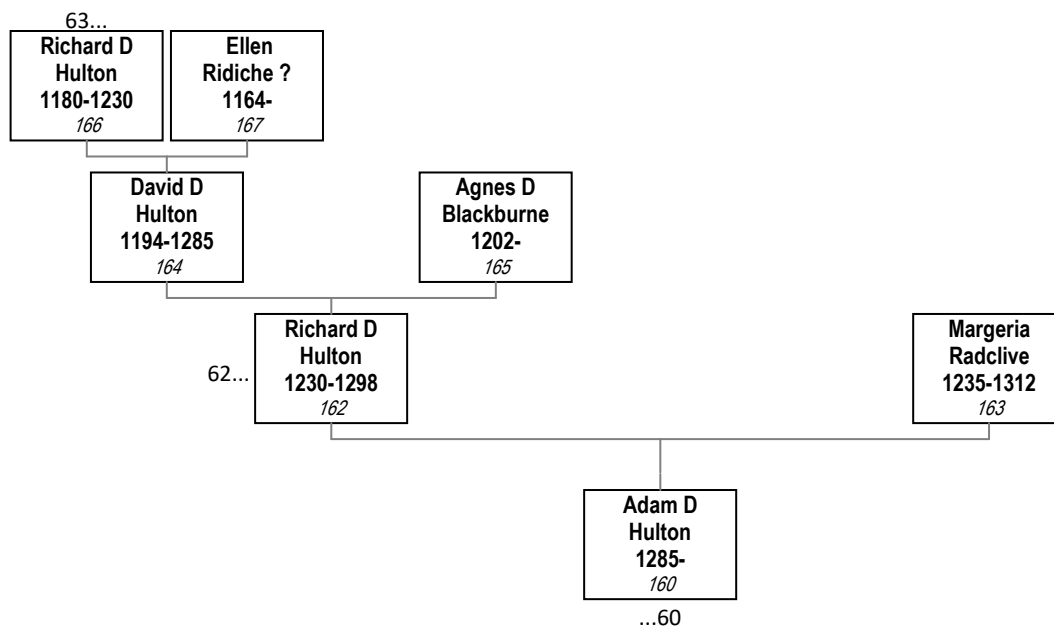

**62. David De Hulton and Agnes De Blackburne**

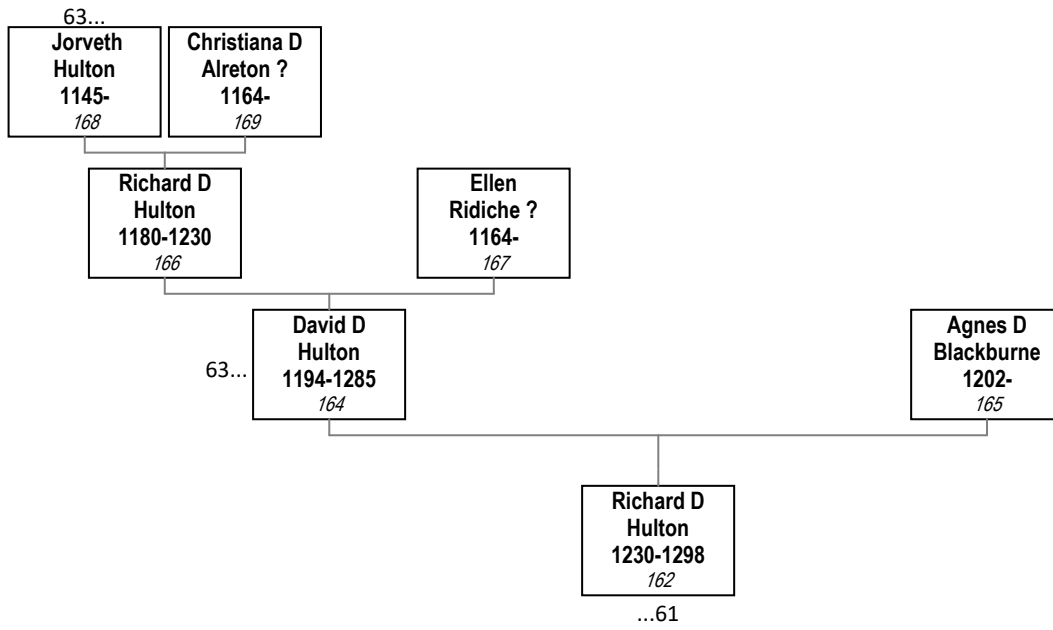

**63. Richard De Hulton and Ellen Ridiche ?**

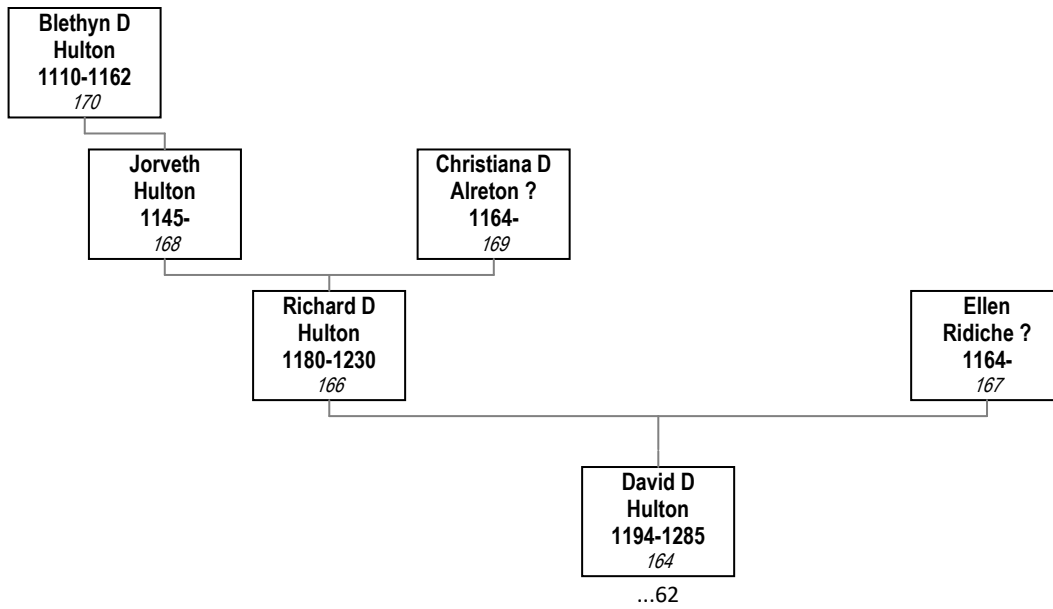

**7. INDEX OF PLACES**

**CANADA**

Death of Margaret (Meg) Hulton<sup>77</sup> on 20 February 2014.

**CANADA, HALIFAX**

Arrival: Frederick John Hulton<sup>73</sup>.

**CANADA, NOVA SCOTIA**

Marriage of Peter Anthony Woods<sup>60</sup> and Beatrix Marian Hulton<sup>61</sup> on 3 May 1945.

**CANADA, ONTARIO**

Death of Frederick Blethyn Hulton<sup>83</sup> in 1958.

Death of Mary Annie Taylor<sup>84</sup> on 7 April 1978.

Death of Elizabeth Hunt (Libby) Hulton<sup>80</sup> in 2004.

**CANADA, ONTARIO, BEETON**

Death of Margaret Helen Smibert<sup>74</sup> on 16 November 2006.

**CANADA, ONTARIO, ELGIN**

Residence of Frederick John Hulton<sup>73</sup> in 1945.

**CANADA, ONTARIO, LONDON**

Residence of Margaret (Meg) Hulton<sup>77</sup> in 1931.

Residence of Margaret Helen Smibert<sup>74</sup> in 1931.

**CANADA, ONTARIO, LONDON, WN**

Residence of Mary Janet Hulton<sup>75</sup> in 1931.

Residence of Beatrix Marian Hulton<sup>61</sup> in 1931.

**CANADA, ONTARIO, LONDON, WON**

Residence of Frederick Blethyn Hulton<sup>83</sup> in 1931.

**CANADA, ONTARIO, LONDON, WV**

Residence of Elizabeth Hunt (Libby) Hulton<sup>80</sup> in 1931.

**CANADA, ONTARIO, MIDDLESEX**

Birth of Margaret Helen Smibert<sup>74</sup> on 9 August 1910.

**CANADA, ONTARIO, MIDDLESEX COUNTY, LONDON**

Burial of Elizabeth Hunt (Libby) Hulton<sup>80</sup>.

**CANADA, ONTARIO, MIDDLESEX, LONDON**

Marriage of Kitchener Thomas Joseph Gill<sup>78</sup> and Margaret (Meg) Hulton<sup>77</sup> on 8 January 1941.

Marriage of Frederick John Hulton<sup>73</sup> and Margaret Helen Smibert<sup>74</sup> on 26 December 1942.

**CANADA, ONTARIO, OXFORD, TILLSONBURG**

Death of James William Hulton<sup>52</sup> on 13 February 1947.

**CANADA, QUEBEC**

Arrival: Mary Janet Hulton<sup>75</sup>.

Arrival: Margaret (Meg) Hulton<sup>77</sup>.

Arrival: Beatrix Marian Hulton<sup>61</sup>.

Arrival: Elizabeth Hunt (Libby) Hulton<sup>80</sup>.

**CANADA, QUEBEC, CHAMPLAIN**

Residence of Kitchener Thomas Joseph Gill<sup>78</sup> in 1931.

**CANADA, QUÉBEC, GRANBY**

Baptism of Kitchener Thomas Joseph Gill<sup>78</sup> '1912–1920'.

**CANADA, QUEBEC, MONTREAL**

Wedding announcement: Brian Joseph Gill<sup>58</sup> on 25 February 1972.

Obituary for GILL Kitchener: Kitchener Thomas Joseph Gill<sup>78</sup> on 3 December 1977.

Obituary for GILL Kitchener: Kitchener Thomas Joseph Gill<sup>78</sup> on 3 December 1977.

Obituary for Margaret GILL: Margaret (Meg) Hulton<sup>77</sup> on 25 February 2014.

**CHESHIRE, STOCKPORT**

- Death of Elizabeth Willis<sup>108</sup> in January 1892.  
 Birth of Amanda Helen Woods<sup>48</sup> in January 1967.  
 Birth of Callum Sean McDonald<sup>20</sup> in September 1997.  
 Birth of Connor Alan McDonald<sup>21</sup> in September 1997.

**DENBIGHSHIRE, WREXHAM**

- Birth of Nerys Woods<sup>47</sup> in April 1959.

**DERBYSHIRE, CHAPEL EN LE FRITH**

- Birth of Hazel Walton<sup>72</sup> in January 1934.

**DURHAM, CHESTER LE STREET**

- Birth of Beatrix Marian Hulton<sup>61</sup> on 3 May 1924.

**DURHAM, SOUTH SHIELDS**

- Birth of Elizabeth Hunt (Libby) Hulton<sup>80</sup> in June 1928.

**ENGLAND**

- Departure: Frederick John Hulton<sup>73</sup> on 13 April 1929.  
 Departure: Margaret (Meg) Hulton<sup>77</sup> on 3 May 1929.  
 Departure: Mary Janet Hulton<sup>75</sup> on 3 May 1929.  
 Departure: Beatrix Marian Hulton<sup>61</sup> on 3 May 1929.  
 Departure: Elizabeth Hunt (Libby) Hulton<sup>80</sup> on 3 May 1929.

**ENGLAND, BEDALE YORKSHIRE, LEASES FARM**

- Birth of Norah Taylor<sup>88</sup> in 1899.

**ENGLAND, BUCKINGHAM, WEXHAM**

- Marriage of William Hulton<sup>113</sup> and Maria Randle Ford<sup>114</sup> on 25 October 1808.

**ENGLAND, CAMBRIDGESHIRE**

- Burial of Martin Craig Watts<sup>27</sup> on 6 September 1996.

**ENGLAND, CHESHIRE**

- Death of Richard Thomas Hunt<sup>107</sup> on 22 September 1874.

**ENGLAND, CHESHIRE, HOLFORD**

- Birth of Elizabeth Legh<sup>137</sup> in 1497.

**ENGLAND, CHESHIRE, HULTON PARK**

- Birth of William Hulton<sup>118</sup> on 6 October 1739.

**ENGLAND, CHESHIRE, ROSTHERNE**

- Birth of Jane Langford Brooke<sup>116</sup> on 7 August 1764.  
 Marriage of William Hulton<sup>115</sup> and Jane Langford Brooke<sup>116</sup> on 23 August 1785.

**ENGLAND, COUNTY DURHAM, DURHAM**

- Residence of Richard George Woods<sup>29</sup> '2012–2014'.

**ENGLAND, DERBYSHIRE, HIGH PEAK**

- Residence of Alan Robert Woods<sup>71</sup>.

**ENGLAND, DERBYSHIRE, PRESTON**

- Residence of Amanda Helen Woods<sup>48</sup> in 2018.

**ENGLAND, DURHAM**

- Death of Mary Ann Watson<sup>106</sup> on 27 June 1855.

**ENGLAND, DURHAM, SEATON CAREW**

- Birth of Frederick Blethyn Hulton<sup>83</sup> on 6 July 1886.

**ENGLAND, DURHAM, SOUTH SHIELDS**

- Death of Ralph William Hulton<sup>79</sup> in July 1927.

**ENGLAND, HALTON WITH AUGHTON LANCASHIRE**

Birth of Ruth Coward<sup>102</sup> on 4 February 1850.

**ENGLAND, KENT, DOVER**

Death of William Ford Ralph Hulton<sup>93</sup> on 16 May 1898.

**ENGLAND, LANCASHIRE**

Birth of Elizabeth Willis<sup>108</sup> on 28 March 1813.

Residence of Peter Anthony Woods<sup>60</sup> in 1939.

Residence of Barbara M Woods<sup>69</sup> in 1939.

Residence of Elizabeth Helen Woods<sup>62</sup> in 1939.

Residence of Alan Robert Woods<sup>71</sup> in 1939.

Residence of Lucy Ellen Marguerita Parker<sup>82</sup> in 1939.

Death of Elizabeth Ann Shaw<sup>90</sup> on 3 May 1945.

**ENGLAND, LANCASHIRE, CATON**

Birth of Elizabeth Ann Shaw<sup>90</sup> on 21 October 1865.

**ENGLAND, LANCASHIRE, DEANE**

Death of Adam Hulton<sup>130</sup> on 29 December 1597.

Marriage of William Tyrrell Boyce<sup>117</sup> and Jane Langford Brooke<sup>116</sup> on 7 May 1804.

Birth of Charles Norleigh Hulton<sup>105</sup> on 10 January 1823.

**ENGLAND, LANCASHIRE, DEANE-BY-BOLTON**

Death of Mary Haseldean<sup>123</sup> on 6 July 1726.

**ENGLAND, LANCASHIRE, DEANE, BOLTON, OVER HULTON, HULTON PARK**

Death of Adam Hulton<sup>138</sup> on 13 February 1530.

**ENGLAND, LANCASHIRE, DEANE, BOLTON, OVER HULTON, HULTON PARK HALL**

Birth of Adam Hulton<sup>138</sup> in 1467.

**ENGLAND, LANCASHIRE, DEANE, BOLTON, WESTHOUGHTON, OVER HULTON, HULTON PARK**

Birth of William (The Patriarch) Hulton<sup>132</sup> in 1540.

Death of William (The Patriarch) Hulton<sup>132</sup> on 18 August 1624.

**ENGLAND, LANCASHIRE, DEANE, HULTON PARK**

Birth of Jessop Hulton<sup>122</sup> in 1667.

Death of Jessop Hulton<sup>122</sup> in 1725.

**ENGLAND, LANCASHIRE, DEANE, OVER HULTON, HULTON PARK, HULTON HALL**

Birth of William Hulton<sup>136</sup> in 1497.

Birth of Adam Hulton<sup>134</sup> in 1519.

Death of William Hulton<sup>136</sup> in 1554.

Death of Elizabeth Legh<sup>137</sup> in 1560.

Death of Adam Hulton<sup>134</sup> on 29 September 1573.

Birth of William Hulton<sup>124</sup> on 9 September 1625.

Death of Anne Jessop<sup>125</sup> on 16 December 1677.

Death of William Hulton<sup>124</sup> on 27 May 1694.

**ENGLAND, LANCASHIRE, FARNWORTH**

Birth of Alicia Hulton<sup>139</sup> about 1469.

Death of Alicia Hulton<sup>139</sup> about 1540.

**ENGLAND, LANCASHIRE, HULTON PARK**

Birth of Mary Haseldean<sup>123</sup> in 1688.

**ENGLAND, LANCASHIRE, HULTON, HULTON PARK, HULTON HALL**

Death of Clemence Norris<sup>135</sup> on 5 February 1595.

**ENGLAND, LANCASHIRE, LANCASTER**

Death of James Woods<sup>89</sup> in June 1935.

Death of Elizabeth Helen Woods<sup>62</sup> in April 1961.

**ENGLAND, LANCASHIRE, LANCASTER, 25 PORTLAND STREET**

Death of Peter Melrose<sup>103</sup> on 12 January 1932.  
 Death of Margaret Smailes<sup>104</sup> on 14 December 1934.

**ENGLAND, LANCASHIRE, LANCASTER, 6 MOOR LANE**

Birth of Joseph Parker<sup>101</sup> on 21 July 1841.

**ENGLAND, LANCASHIRE, LANCASTER, GREEN LANE, DAISYFIELD**

Death of Jane Ellen Archbold Smailes Melrose<sup>92</sup> on 17 March 1951.

**ENGLAND, LANCASHIRE, LITTLE HULTON**

Birth of Ann Hall<sup>119</sup> in 1742.  
 Death of Ann Hall<sup>119</sup> in 1802.

**ENGLAND, LANCASHIRE, LIVERPOOL**

Birth of Clemence Norris<sup>135</sup> in 1509.

**ENGLAND, LANCASHIRE, LIVERPOOL NORTH**

Death of Michael A E Hopkins<sup>32</sup> in March 1944.

**ENGLAND, LANCASHIRE, LUNESDALE**

Death of Anthony Shaw<sup>99</sup> in January 1882.  
 Death of Ruth Coward<sup>102</sup> in December 1923.  
 Death of Joseph Parker<sup>101</sup> in March 1925.  
 Birth of Barbara M Woods<sup>69</sup> on 9 November 1927.

**ENGLAND, LANCASHIRE, MANCHESTER**

Birth of Alice Baguley<sup>131</sup> in 1551.  
 Birth of Marian Hunt<sup>94</sup> on 3 May 1848.

**ENGLAND, LANCASHIRE, NETHER KELLET**

Birth of Henry Preston Woods<sup>97</sup> about 1830.  
 Birth of James Anthony Woods<sup>81</sup> in 1892.  
 Death of Henry Preston Woods<sup>97</sup> in 1907.  
 Birth of Peter Anthony Woods<sup>60</sup> on 12 March 1921.  
 Death of James Anthony Woods<sup>81</sup> on 11 August 1934.

**ENGLAND, LANCASHIRE, NETHER KELLETT**

Birth of James Woods<sup>89</sup> about 1864.

**ENGLAND, LANCASHIRE, OVER HULTON**

Birth of William Hulton<sup>113</sup> on 23 October 1787.

**ENGLAND, LANCASHIRE, PRESTON**

Residence of Peter Anthony Woods<sup>60</sup>.  
 Residence of Beatrix Marian Hulton<sup>61</sup>.  
 Death of Henry Parker<sup>91</sup> in October 1954.

**ENGLAND, LANCASHIRE, PRESTON (Continued)**

Birth of Jane Elizabeth Woods<sup>26</sup> on 25 May 1957.  
 Death of Whitendale Taylor<sup>64</sup> in July 1964.

**ENGLAND, LANCASHIRE, PRESTON AND SOUTH RIBBLE**

Death of Martin Craig Watts<sup>27</sup> on 26 August 1996.

**ENGLAND, LANCASHIRE, PRESTON, BAMBER BRIDGE, CHARNLEY FOLD HOUSE**

Death of Lucy Ellen Marguerita Parker<sup>82</sup> on 22 October 1976.

**ENGLAND, LANCASHIRE, QUERNMORE**

Birth of Anthony Shaw<sup>99</sup> on 20 October 1832.

**ENGLAND, LANCASHIRE, ST MARY, LANCASTER PRIORY**

Marriage of Henry Parker<sup>91</sup> and Jane Ellen Archbold Smailes Melrose<sup>92</sup> on 12 June 1897.

**ENGLAND, LANCASHIRE, ST MICHAEL'S**

Birth of Jane Reynolds<sup>98</sup> on 25 January 1825.

**ENGLAND, LANCASHIRE, WESTHOUGHTON**

Birth of Mary Leigh<sup>121</sup> in 1714.

**ENGLAND, LANCASHIRE, WYRESDALE, ABBYSTED, THE SHOOTING BOX**

Birth of Lucy Ellen Marguerita Parker<sup>82</sup> on 24 September 1897.

**ENGLAND, LANCASHIRE, WYRESDALE, SCORTON, HAYSHAW FARM**

Birth of Henry Parker<sup>91</sup> on 3 September 1875.

**ENGLAND, LONDON, MIDDLESEX, HIGH HOLBURN, WARWICK HOUSE**

Birth of Anne Jessop<sup>125</sup> about 1629.

**ENGLAND, MIDDLESEX, LONDON**

Birth of Maria Randle Ford<sup>114</sup> in 1790.

**ENGLAND, MIDDLESEX, MARYLEBONE**

Death of Jane Langford Brooke<sup>116</sup> on 7 December 1845.

**ENGLAND, NORTH YORKSHIRE, HAMBLETON DISTRICT, STOKESLEY**

Birth of William Ford Ralph Hulton<sup>93</sup> in September 1848.

**ENGLAND, NORTHALLERTON YORKSHIRE**

Birth of Mary Janet Hulton<sup>75</sup> on 21 February 1913.

**ENGLAND, NORTHUMBERLAND, CRASTER**

Birth of Margaret Smailes<sup>104</sup> on 9 June 1852.

**ENGLAND, NORTHUMBERLAND, EMBLETON, DUNSTAN, NORTH SIDE, CRASTER**

Birth of Jane Ellen Archbold Smailes Melrose<sup>92</sup> on 23 April 1875.

**ENGLAND, NORTHUMBERLAND, NEWCASTLE UPON TYNE, NEWCASTLE CATHEDRAL**

Marriage of Peter Melrose<sup>103</sup> and Margaret Smailes<sup>104</sup> on 14 February 1875.

**ENGLAND, NOTTINGHAMSHIRE, SUTTON IN ASHFIELD**

Birth of Michael Lee Slack<sup>3</sup> on 3 March 1989.

**ENGLAND, OXFORDSHIRE, BURFORD**

Birth of Richard Thomas Hunt<sup>107</sup> on 30 September 1802.

**ENGLAND, SHROPSHIRE, LUDLOW**

Birth of Elizabeth Edwards<sup>100</sup> about 1833.

**ENGLAND, SURREY, MITCHAM**

Residence of Alastair Richard Woods<sup>6</sup> in 2012.

**ENGLAND, WARWICKSHIRE, LEAMINGTON SPA**

Death of William Hulton<sup>113</sup> on 31 March 1864.

**ENGLAND, WEST YORKSHIRE, YORKSHIRE, WEST RIDING, KEIGHLEY**

Birth of Margaret Keighley<sup>133</sup> in 1545.

**ENGLAND, YORK, STOKESLEY**

Marriage of Charles Norleigh Hulton<sup>105</sup> and Mary Ann Watson<sup>106</sup> on 13 March 1844.

**ENGLAND, YORKSHIRE**

Birth of Frederick John Hulton<sup>73</sup> about 1911.

Death of John Benjamin Taylor<sup>95</sup> on 7 May 1935.

**ENGLAND, YORKSHIRE (WEST RIDING), AUSTWICK**

Residence of Frederick John Hulton<sup>73</sup> in 1921.

**ENGLAND, YORKSHIRE NORTH RIDING, BEDALE**

Birth of Mary Annie Taylor<sup>84</sup> on 4 May 1886.

**ENGLAND, YORKSHIRE NORTH RIDING, NORTHALLERTON**

Birth of Ralph William Hulton<sup>79</sup> in July 1915.  
 Death of Norah Taylor<sup>88</sup> in December 1961.  
 Death of Janet Isabel Taylor<sup>85</sup> in December 1966.

**ENGLAND, YORKSHIRE, AINDERBY STEEPLE**

Birth of William Robson<sup>111</sup> in June 1821.  
 Birth of Mary Jennet Robson<sup>96</sup> on 28 August 1861.  
 Death of William Robson<sup>111</sup> on 15 April 1896.  
 Death of Jennet Mackay<sup>112</sup> on 31 May 1905.

**ENGLAND, YORKSHIRE, BEDALE**

Marriage of Frederick Blethyn Hulton<sup>83</sup> and Mary Annie Taylor<sup>84</sup> in January 1911.  
 Death of Mary Jennet Robson<sup>96</sup> on 13 February 1913.

**ENGLAND, YORKSHIRE, COWESBY**

Birth of Mary Atlay<sup>110</sup> about 1829.

**ENGLAND, YORKSHIRE, NORTHALLERTON**

Baptism of Ralph William Hulton<sup>79</sup> on 14 July 1915.

**ENGLAND, YORKSHIRE, STOKESLEY**

Birth of Mary Ann Watson<sup>106</sup> about 1827.

**ENGLAND, YORKSHIRE, UPSALL**

Birth of John Benjamin Taylor<sup>95</sup> on 7 July 1855.

**FLORIDA**

Residence of Mary Janet Hulton<sup>75</sup> in 1975.  
 Death of Mary Janet Hulton<sup>75</sup> on 3 March 2000.

**FRANCE AND FLANDERS**

Death of John W Taylor<sup>87</sup> on 18 March 1917.

**FRANCE, CALAIS**

Death of William Tyrrell Boyce<sup>117</sup> in July 1838.

**FRANCE, NICE**

Death of William Hulton<sup>118</sup> in 1775.

**GERMANY, SAXONY-ANHALT, BÖRDE, ALTONA**

Death of Charles Norleigh Hulton<sup>105</sup> on 2 March 1870.

**LANCASHIRE, AMOUNDERNESS**

Birth of Peter John Woods<sup>31</sup> in September 1949.  
 Birth of Alastair Richard Woods<sup>6</sup> in January 1969.

**LANCASHIRE, CLITHEROE**

Birth of Whitendale Taylor<sup>64</sup> on 23 May 1910.

**LANCASHIRE, LANCASTER**

Birth of Alan Robert Woods<sup>71</sup> on 22 March 1935.  
 Birth of Richard George Woods<sup>29</sup> in April 1946.  
 Birth of John A Taylor<sup>37</sup> in October 1959.  
 Birth of Michael A Logue<sup>10</sup> in July 1965.  
 Birth of Helen Josephine Logue<sup>11</sup> in April 1967.  
 Birth of Catherine Alice Logue<sup>12</sup> in April 1968.  
 Birth of Robert Taylor<sup>13</sup> in July 1988.  
 Birth of Lynne Margaret Taylor<sup>18</sup> in February 1991.  
 Birth of Jennifer Taylor<sup>15</sup> in April 1992.  
 Birth of Georgina Audrey Lister<sup>19</sup> in August 1992.

**LANCASHIRE, LIVERPOOL NORTH**

Birth of Rosemary Hopkins<sup>33</sup> in October 1944.

**LANCASHIRE, LUNESDALE**

Birth of Elizabeth Helen Woods<sup>62</sup> on 12 December 1922.  
 Birth of John James Melrose Woods<sup>65</sup> in January 1924.  
 Birth of Jean Margaret Woods<sup>67</sup> in April 1925.  
 Birth of Michael A E Hopkins<sup>32</sup> in October 1942.  
 Birth of David Taylor<sup>35</sup> in April 1957.

**LANCASHIRE, OVER HULTON, HULTON PARK**

Birth of William Hulton<sup>120</sup> on 22 June 1717.  
 Death of William Hulton<sup>120</sup> in April 1741.

**LANCASHIRE, PRESTON**

Birth of Margaret Mackenzie<sup>30</sup> in January 1946.  
 Birth of Jennifer Clare Woods<sup>4</sup> in January 1968.

**LANCASHIRE, YEALAND CONYERS, ST JOHN**

Marriage of James Anthony Woods<sup>81</sup> and Lucy Ellen Marguerita Parker<sup>82</sup> on 4 February 1920.

**LANCASTER**

Death of John James Melrose Woods<sup>65</sup> on 2 January 1969.  
 Probate: John James Melrose Woods<sup>65</sup> on 11 April 1969.

**MERSEYSIDE, LIVERPOOL**

Birth of Michael A C Hopkins<sup>63</sup> on 12 June 1917.

**NORTH YORKSHIRE, WELBURY**

Birth of John Taylor<sup>109</sup> in 1821.

**OF HULTON PARK**

Birth of Adam Hulton<sup>130</sup> on 4 February 1557.

**ONTARIO**

Birth of James William Hulton<sup>52</sup> on 9 February 1947.

**ONTARIO, LONDON**

Death of Kitchener Thomas Joseph Gill<sup>78</sup> on 1 December 1977.

**ONTARIO, MIDDLESEX EAST**

Residence of Margaret Helen Smibert<sup>74</sup> in 1911.

**ONTARIO, PARRY SOUND**

Residence of Frederick John Hulton<sup>73</sup> '1995 1996 1997 1998 1999'.

**PARRY SOUND**

Death of Frederick John Hulton<sup>73</sup> in 1998.

**PRESTON**

Death of Peter Anthony Woods<sup>60</sup> on 29 May 2007.

**QUEBEC, GRAND MERE**

Birth of Kitchener Thomas Joseph Gill<sup>78</sup> on 21 May 1916.

**SCOTLAND, CAITHNESS, THURSO**

Birth of Jennet Mackay<sup>112</sup> in 1822.

**SCOTLAND, PEEBLESSHIRE, PEEBLES, GLENSAX**

Birth of Peter Melrose<sup>103</sup> on 6 April 1851.

**SCOTLAND, PERTSHIRE, ALYTH**

Death of Jane Elizabeth Woods<sup>26</sup> on 27 September 2024.

**SURREY, CROYDON**

Birth of William Tyrrell Boyce<sup>117</sup> on 24 October 1780.

**UNITED KINGDOM, DERBYSHIRE, CHAPEL EN LE FRITH**

Marriage of Alan Robert Woods<sup>71</sup> and Hazel Walton<sup>72</sup> in April 1958.

**UNITED KINGDOM, DERBYSHIRE, HIGH PEAK**

Marriage of Sean P McDonald<sup>49</sup> and Amanda Helen Woods<sup>48</sup> in 1987.

**UNITED KINGDOM, ENGLAND, CHESHIRE, DISLEY, SAINT MARY**

Marriage of William Ford Ralph Hulton<sup>93</sup> and Marian Hunt<sup>94</sup> on 23 April 1878.

**UNITED KINGDOM, ENGLAND, COUNTY DURHAM, STOCKTON**

Death of Marian Hunt<sup>94</sup> on 15 April 1938.

**UNITED KINGDOM, ENGLAND, DERBYSHIRE, BUXTON**

Residence of Amanda Helen Woods<sup>48</sup> '2003–2010'.

**UNITED KINGDOM, ENGLAND, LANCASHIRE, (16)(DEANE), HULTON PARK**

Death of Adam Hulton<sup>126</sup> on 16 September 1651.

**UNITED KINGDOM, ENGLAND, LANCASHIRE, (DEANE), HULTON PARK**

Birth of Adam Hulton<sup>126</sup> on 1 July 1607.

**UNITED KINGDOM, ENGLAND, LANCASHIRE, CHORLEY**

Residence of Andrew John Jameson<sup>28</sup> '2005–2010'.

Residence of Jane Elizabeth Woods<sup>26</sup> '2004–2010'.

Residence of Rachel Jane Watts<sup>2</sup> '2008–2010'.

**UNITED KINGDOM, ENGLAND, LANCASHIRE, HULTON PARK**

Marriage of Adam Hulton<sup>130</sup> and Alice Baguley<sup>131</sup> in 1567.

**UNITED KINGDOM, ENGLAND, LANCASHIRE, LANCASTER**

Residence of John A Taylor<sup>37</sup> '2003, 2005–2010'.

Residence of James William Taylor<sup>17</sup> '2006–2010'.

**UNITED KINGDOM, ENGLAND, LANCASHIRE, PRESTON**

Residence of Beatrix Marian Hulton<sup>61</sup> '2003–2008'.

Death of Beatrix Marian Hulton<sup>61</sup> on 13 September 2008.

**UNITED KINGDOM, ENGLAND, LANCASHIRE, ST MARY, LANCASTER**

Marriage of Richard Thomas Hunt<sup>107</sup> and Elizabeth Willis<sup>108</sup> on 12 June 1838.

**UNITED KINGDOM, ENGLAND, MERSEYSIDE, NEWTON-LE-WILLOWS**

Residence of Leonard Stewart Taylor<sup>42</sup> '2003–2010'.

**UNITED KINGDOM, ENGLAND, SHROPSHIRE, TELFORD**

Residence of Michael Lee Slack<sup>3</sup> '2007–2008'.

**UNITED KINGDOM, ENGLAND, SURREY, MITCHAM**

Residence of Alastair Richard Woods<sup>6</sup> '2003–2008'.

**UNITED KINGDOM, LANCASHIRE**

Death of Jane Reynolds<sup>98</sup> in March 1909.

Death of Elizabeth Edwards<sup>100</sup> in January 1912.

**UNITED KINGDOM, LANCASHIRE, AMOUNDERNESS**

Marriage of Richard George Woods<sup>29</sup> and Margaret Mackenzie<sup>30</sup> in July 1967.

**UNITED KINGDOM, LANCASHIRE, GARSTANG**

Marriage of John A Taylor<sup>37</sup> and Margaret M Swarbrick<sup>38</sup> in 1984.

**UNITED KINGDOM, LANCASHIRE, LANCASTER**

Marriage of Thomas B Logue<sup>34</sup> and Rosemary Hopkins<sup>33</sup> in July 1964.

Marriage of David Taylor<sup>35</sup> and Veronica Ann Cairns<sup>36</sup> in 1986.

**UNITED KINGDOM, LANCASHIRE, LUNESDALE**

Marriage of Michael A C Hopkins<sup>63</sup> and Elizabeth Helen Woods<sup>62</sup> in January 1942.  
Marriage of George A Saunders<sup>68</sup> and Jean Margaret Woods<sup>67</sup> in July 1943.  
Marriage of Robert (Roy) J Graham<sup>70</sup> and Barbara M Woods<sup>69</sup> in July 1946.  
Marriage of John James Melrose Woods<sup>65</sup> in July 1949.  
Marriage of Whitendale Taylor<sup>64</sup> and Elizabeth Helen Woods<sup>62</sup> in October 1953.  
Marriage of Leonard Stewart Taylor<sup>42</sup> and Gillian Saunders<sup>41</sup> in April 1967.

**UNITED KINGDOM, LANCASHIRE, PRESTON AND RIBBLE**

Marriage of Martin Craig Watts<sup>27</sup> and Jane Elizabeth Woods<sup>26</sup> in August 1979.

**USA, NORTH CAROLINA, DURHAM**

Residence of Jennifer Clare Woods<sup>4</sup> '1996–2020'.

**USA, NORTH CAROLINA, DURHAM COUNTY**

Marriage of David Rowson<sup>5</sup> and Jennifer Clare Woods<sup>4</sup> in January 2022.

**WARWICKSHIRE, WARWICK**

Death of Maria Randle Ford<sup>114</sup> on 5 April 1866.

**WEST MIDLANDS, BIRMINGHAM**

Birth of Gillian Saunders<sup>41</sup> in July 1944.

**YORKSHIRE - NORTH RIDING, THIRSK**

Marriage of John Taylor<sup>109</sup> and Mary Atlay<sup>110</sup> in September 1852.

**YORKSHIRE ENGLAND**

Birth of Margaret (Meg) Hulton<sup>77</sup> on 13 March 1914.

**YORKSHIRE NORTH RIDING, BEDALE**

Birth of Janet Isabel Taylor<sup>85</sup> on 6 November 1887.  
Birth of Alice M Taylor<sup>86</sup> in 1890.  
Birth of John W Taylor<sup>87</sup> in 1894.

**YORKSHIRE NORTH RIDING, NORTHALLERTON**

Death of Mary Atlay<sup>110</sup> in July 1884.  
Death of John Taylor<sup>109</sup> in April 1894.

**YORKSHIRE NORTH RIDING, RICHMOND**

Birth(?) of Frederick John Hulton<sup>73</sup> on 9 November 1911.

**YORKSHIRE NORTH RIDING, STOKESLEY**

Marriage of Charles Norleigh Hulton<sup>105</sup> in January 1844.

**8. INDEX OF DATES**

- 1110** Birth of Blethyn De Hulton<sup>170</sup>.
- 1145** Birth of Jorveth (Yarwrit) De Hulton<sup>168</sup>.
- 1160** Story (This family is of Welsh origin; the first Lancashire members of it—Iorwerth (d. 1215) and Madoc, sons of Bleiddyn—are supposed to have been among the faithful vassals of Robert Banastre, expelled from Wales about 1167): Blethyn De Hulton<sup>170</sup>.
- 1162** Death of Blethyn De Hulton<sup>170</sup>.
- 1164** Birth of Christiana De Alreton ?<sup>169</sup>.  
Birth of Ellen Ridiche ?<sup>167</sup>.
- 1180** Birth of Richard De Hulton<sup>166</sup>.
- 1194** Birth of David De Hulton<sup>164</sup>.
- 1202** Birth of Agnes De Blackburne<sup>165</sup>.
- 1230** Birth of Richard De Hulton<sup>162</sup>.  
Death of Richard De Hulton<sup>166</sup>.
- 1235** Birth of Margeria Radclive<sup>163</sup>.
- 1285** Birth of Adam De Hulton<sup>160</sup>.  
Death of David De Hulton<sup>164</sup>.
- 1298** Death of Richard De Hulton<sup>162</sup>.
- 1308** Birth of Alicia De Eccles<sup>161</sup>.
- 1312** Death of Margeria Radclive<sup>163</sup>.
- 1335** Birth of Alyne De Lever<sup>159</sup>.
- 1336** Birth of Roger De Hulton<sup>158</sup>.
- 1349** Birth of Agnes De Legh<sup>157</sup>.
- 1350** Birth of Roger De Hulton<sup>156</sup>.
- 1358** Birth of John De Hulton<sup>154</sup>.
- 1362** Birth of Isabella Atherton<sup>155</sup>.
- 1366** Birth of Alice De Culcheth ?<sup>153</sup>.  
Birth of Adam De Hulton<sup>152</sup>.
- 1386** Birth of Roger De Hulton<sup>148</sup>.
- 1388** Birth of Elena De Hulton<sup>149</sup>.  
Birth of James De Hulton<sup>150</sup>.
- 1405** Birth of Helen Farnsworth ?<sup>145</sup>.
- 1410** Birth of Roger Hulton<sup>144</sup>.
- 1411** Death of Roger De Hulton<sup>156</sup>.
- 1413** Birth of Margaret Tyldesley<sup>147</sup>.
- 1419** Birth of William Hulton<sup>146</sup>.
- 1431** Death of Adam De Hulton<sup>152</sup>.

- 1449**  
Birth of Katherine Harrington<sup>141</sup>.
- 1450**  
Birth of Roger Hulton<sup>140</sup>.
- 1452**  
Birth of John Hulton<sup>142</sup>.
- 1459**  
Death of Roger De Hulton<sup>148</sup>.
- 1460**  
Death of Helen Farnsworth?<sup>145</sup>.
- 1467**  
Birth of Adam Hulton<sup>138</sup> in Hulton Park Hall, Over Hulton, Bolton, Deane, Lancashire, England.
- 1469**  
Birth of Alicia Hulton<sup>139</sup> in about 1469, in Farnworth, Lancashire, England.
- 1489**  
Marriage of Adam Hulton<sup>138</sup> and Alicia Hulton<sup>139</sup> in May.
- 1497**  
Birth of William Hulton<sup>136</sup> in Hulton Hall, Hulton Park, Over Hulton, Deane, Lancashire, England.  
Birth of Elizabeth Legh<sup>137</sup> in Holford, Cheshire, England.
- 1500**  
Death of Katherine Harrington<sup>141</sup>.
- 1503**  
Death of John Hulton<sup>142</sup>.
- 1509**  
Birth of Clemence Norris<sup>135</sup> in Liverpool, Lancashire, England.
- 1519**  
Birth of Adam Hulton<sup>134</sup> in Hulton Hall, Hulton Park, Over Hulton, Deane, Lancashire, England.
- 1520**  
Death of Roger Hulton<sup>140</sup>.
- 1530**  
Death of Adam Hulton<sup>138</sup> on 13 February, in Hulton Park, Over Hulton, Bolton, Deane, Lancashire, England.
- 1534**  
Marriage of Adam Hulton<sup>134</sup> and Clemence Norris<sup>135</sup> in November.
- 1540**  
Birth of William (The Patriarch) Hulton<sup>132</sup> in Hulton Park, Over Hulton, Westhoughton, Bolton, Deane, Lancashire, England.  
Death of Alicia Hulton<sup>139</sup> in about 1540, in Farnworth, Lancashire, England.
- 1545**  
Birth of Margaret Keighley<sup>133</sup> in Keighley, West Riding, Yorkshire, West Yorkshire, England.
- 1551**  
Birth of Alice Baguley<sup>131</sup> in Manchester, Lancashire, England.
- 1554**  
Death of William Hulton<sup>136</sup> in Hulton Hall, Hulton Park, Over Hulton, Deane, Lancashire, England.
- 1557**  
Birth of Adam Hulton<sup>130</sup> on 4 February, in Of Hulton Park.
- 1560**  
Death of Elizabeth Legh<sup>137</sup> in Hulton Hall, Hulton Park, Over Hulton, Deane, Lancashire, England.
- 1567**  
Marriage of Adam Hulton<sup>130</sup> and Alice Baguley<sup>131</sup> in Hulton Park, Lancashire, England, United Kingdom.
- 1573**  
Death of Adam Hulton<sup>134</sup> on 29 September, in Hulton Hall, Hulton Park, Over Hulton, Deane, Lancashire, England.
- 1576**  
Birth of William Hulton<sup>128</sup>.
- 1580**  
Marriage of William (The Patriarch) Hulton<sup>132</sup>.
- 1581**  
Birth of Katherine Hyde<sup>129</sup>.
- 1595**  
Death of Clemence Norris<sup>135</sup> on 5 February, in Hulton Hall, Hulton Park, Hulton, Lancashire, England.
- 1597**  
Death of Adam Hulton<sup>130</sup> on 29 December, in Deane, Lancashire, England.
- 1607**  
Birth of Adam Hulton<sup>126</sup> on 1 July, in Hulton Park, (Deane), Lancashire, England, United Kingdom.
- 1613**  
Death of William Hulton<sup>128</sup> on 6 September.

- 1624**  
Death of William (The Patriarch) Hulton<sup>132</sup> on 18 August, in Hulton Park, Over Hulton, Westhoughton, Bolton, Deane, Lancashire, England.
- 1625**  
Birth of William Hulton<sup>124</sup> on 9 September, in Hulton Hall, Hulton Park, Over Hulton, Deane, Lancashire, England.
- 1629**  
Birth of Anne Jessop<sup>125</sup> in about 1629, in Warwick House, High Holburn, Middlesex, London, England.
- 1647**  
Death of Alice Baguley<sup>131</sup>.
- 1651**  
Death of Adam Hulton<sup>126</sup> on 16 September, in Hulton Park, (16)(Deane), Lancashire, England, United Kingdom.
- 1655**  
Death of Katherine Hyde<sup>129</sup>.
- 1667**  
Birth of Jessop Hulton<sup>122</sup> in Hulton Park, Deane, Lancashire, England.
- 1677**  
Death of Anne Jessop<sup>125</sup> on 16 December, in Hulton Hall, Hulton Park, Over Hulton, Deane, Lancashire, England.
- 1688**  
Birth of Mary Haseldean<sup>123</sup> in Hulton Park, Lancashire, England.
- 1694**  
Death of William Hulton<sup>124</sup> on 27 May, in Hulton Hall, Hulton Park, Over Hulton, Deane, Lancashire, England.
- 1714**  
Birth of Mary Leigh<sup>121</sup> in Westhoughton, Lancashire, England.
- 1717**  
Birth of William Hulton<sup>120</sup> on 22 June, in Hulton Park, Over Hulton, Lancashire.
- 1725**  
Death of Jessop Hulton<sup>122</sup> in Hulton Park, Deane, Lancashire, England.
- 1726**  
Death of Mary Haseldean<sup>123</sup> on 6 July, in Deane-By-Bolton, Lancashire, England.
- 1739**  
Birth of William Hulton<sup>118</sup> on 6 October, in Hulton Park, Cheshire, England.
- 1741**  
Death of William Hulton<sup>120</sup> in April, in Hulton Park, Over Hulton, Lancashire.
- 1742**  
Birth of Ann Hall<sup>119</sup> in Little Hulton, Lancashire, England.
- 1762**  
Birth of William Hulton<sup>115</sup> on 28 May.
- 1764**  
Birth of Jane Langford Brooke<sup>116</sup> on 7 August, in Rostherne, Cheshire, England.
- 1766**  
Death of Mary Leigh<sup>121</sup> in about 1766.
- 1775**  
Death of William Hulton<sup>118</sup> in Nice, France.
- 1780**  
Birth of William Tyrrell Boyce<sup>117</sup> on 24 October, in Croydon, Surrey.
- 1785**  
Marriage of William Hulton<sup>115</sup> and Jane Langford Brooke<sup>116</sup> on 23 August, in Rostherne, Cheshire, England.
- 1787**  
Birth of William Hulton<sup>113</sup> on 23 October, in Over Hulton, Lancashire, England.
- 1790**  
Birth of Maria Randle Ford<sup>114</sup> in London, Middlesex, England.
- 1800**  
Death of William Hulton<sup>115</sup> on 24 June.
- 1802**  
Death of Ann Hall<sup>119</sup> in Little Hulton, Lancashire, England.  
Birth of Richard Thomas Hunt<sup>107</sup> on 30 September, in Burford, Oxfordshire, England.
- 1804**  
Marriage of William Tyrrell Boyce<sup>117</sup> and Jane Langford Brooke<sup>116</sup> on 7 May, in Deane, Lancashire, England.
- 1808**  
Marriage of William Hulton<sup>113</sup> and Maria Randle Ford<sup>114</sup> on 25 October, in Wexham, Buckingham, England.
- 1813**  
Birth of Elizabeth Willis<sup>108</sup> on 28 March, in Lancashire, England.
- 1821**  
Birth of William Robson<sup>111</sup> in June, in Ainderby Steeple, Yorkshire, England.  
Birth of John Taylor<sup>109</sup> in Welbury, North Yorkshire.

- 1822**  
Birth of Jennet Mackay<sup>112</sup> in Thurso, Caithness, Scotland.
- 1823**  
Birth of Charles Norleigh Hulton<sup>105</sup> on 10 January, in Deane, Lancashire, England.
- 1825**  
Birth of Jane Reynolds<sup>98</sup> on 25 January, in St Michael's, Lancashire, England.
- 1827**  
Birth of Mary Ann Watson<sup>106</sup> in about 1827, in Stokesley, Yorkshire, England.
- 1829**  
Birth of Mary Atlay<sup>110</sup> in about 1829, in Cowesby, Yorkshire, England.
- 1830**  
Birth of Henry Preston Woods<sup>97</sup> in about 1830, in Nether Kellet, Lancashire, England.
- 1832**  
Birth of Anthony Shaw<sup>99</sup> on 20 October, in Quernmore, Lancashire, England.
- 1833**  
Birth of Elizabeth Edwards<sup>100</sup> in about 1833, in Ludlow, Shropshire, England.
- 1838**  
Marriage of Richard Thomas Hunt<sup>107</sup> and Elizabeth Willis<sup>108</sup> on 12 June, in Lancaster, St Mary, Lancashire, England, United Kingdom.  
Death of William Tyrrell Boyce<sup>117</sup> in July, in Calais, France.
- 1841**  
Birth of Joseph Parker<sup>101</sup> on 21 July, in 6 Moor Lane, Lancaster, Lancashire, England.
- 1844**  
Marriage of Charles Norleigh Hulton<sup>105</sup> in January, in Stokesley, Yorkshire North Riding.  
Marriage of Charles Norleigh Hulton<sup>105</sup> and Mary Ann Watson<sup>106</sup> on 13 March, in Stokesley, York, England.
- 1845**  
Death of Jane Langford Brooke<sup>116</sup> on 7 December, in Marylebone, Middlesex, England.
- 1848**  
Birth of Marian Hunt<sup>94</sup> on 3 May, in Manchester, Lancashire, England.  
Birth of William Ford Ralph Hulton<sup>93</sup> in September, in Stokesley, Hambleton District, North Yorkshire, England.
- 1850**  
Birth of Ruth Coward<sup>102</sup> on 4 February, in Halton with Aughton Lancashire, England.
- 1851**  
Birth of Peter Melrose<sup>103</sup> on 6 April, in Glensax, Peebles, Peeblesshire, Scotland.
- 1852**  
Birth of Margaret Smailes<sup>104</sup> on 9 June, in Craster, Northumberland, England.  
Marriage of John Taylor<sup>109</sup> and Mary Atlay<sup>110</sup> in September, in Thirsk, Yorkshire - North Riding.
- 1855**  
Death of Mary Ann Watson<sup>106</sup> on 27 June, in Durham, England.  
Birth of John Benjamin Taylor<sup>95</sup> on 7 July, in Upsall, Yorkshire, England.
- 1861**  
Birth of Mary Jennet Robson<sup>96</sup> on 28 August, in Ainderby Steeple, Yorkshire, England.
- 1864**  
Death of William Hulton<sup>113</sup> on 31 March, in Leamington Spa, Warwickshire, England.  
Birth of James Woods<sup>89</sup> in about 1864, in Nether Kellet, Lancashire, England.
- 1865**  
Birth of Elizabeth Ann Shaw<sup>90</sup> on 21 October, in Caton, Lancashire, England.
- 1866**  
Death of Maria Randle Ford<sup>114</sup> on 5 April, in Warwick, Warwickshire.
- 1870**  
Death of Charles Norleigh Hulton<sup>105</sup> on 2 March, in Altona, Börde, Saxony-Anhalt, Germany.
- 1874**  
Death of Richard Thomas Hunt<sup>107</sup> on 22 September, in Cheshire, England.
- 1875**  
Marriage of Peter Melrose<sup>103</sup> and Margaret Smailes<sup>104</sup> on 14 February, in Newcastle Cathedral, Newcastle Upon Tyne, Northumberland, England.  
Birth of Jane Ellen Archbold Smailes Melrose<sup>92</sup> on 23 April, in Craster, North Side, Dunstan, Embleton, Northumberland, England.  
Birth of Henry Parker<sup>91</sup> on 3 September, in Hayshaw Farm, Scorton, Wyresdale, Lancashire, England.
- 1878**  
Marriage of William Ford Ralph Hulton<sup>93</sup> and Marian Hunt<sup>94</sup> on 23 April, in Saint Mary, Disley, Cheshire, England, United Kingdom.
- 1882**  
Death of Anthony Shaw<sup>99</sup> in January, in Lunesdale, Lancashire, England.
- 1884**  
Death of Mary Atlay<sup>110</sup> in July, in Northallerton, Yorkshire North Riding.

- 1886**  
 Birth of Mary Annie Taylor<sup>84</sup> on 4 May, in Bedale, Yorkshire North Riding, England.  
 Birth of Frederick Blethyn Hulton<sup>83</sup> on 6 July, in Seaton Carew, Durham, England.
- 1887**  
 Birth of Janet Isabel Taylor<sup>85</sup> on 6 November, in Bedale, Yorkshire North Riding.
- 1890**  
 Birth of Alice M Taylor<sup>86</sup> in Bedale, Yorkshire North Riding.
- 1892**  
 Death of Elizabeth Willis<sup>108</sup> in January, in Stockport, Cheshire.  
 Birth of James Anthony Woods<sup>81</sup> in Nether Kellet, Lancashire, England.
- 1894**  
 Death of John Taylor<sup>109</sup> in April, in Northallerton, Yorkshire North Riding.  
 Birth of John W Taylor<sup>87</sup> in Bedale, Yorkshire North Riding.
- 1896**  
 Death of William Robson<sup>111</sup> on 15 April, in Ainderby Steeple, Yorkshire, England.
- 1897**  
 Marriage of Henry Parker<sup>91</sup> and Jane Ellen Archbold Smailes Melrose<sup>92</sup> on 12 June, in Lancaster Priory, St Mary, Lancashire, England.  
 Birth of Lucy Ellen Marguerita Parker<sup>82</sup> on 24 September, in The Shooting Box, Abbystead, Wyresdale, Lancashire, England.
- 1898**  
 Death of William Ford Ralph Hulton<sup>93</sup> on 16 May, in Dover, Kent, England.
- 1899**  
 Birth of Norah Taylor<sup>88</sup> in Leases Farm, Bedale Yorkshire, England.
- 1905**  
 Death of Jennet Mackay<sup>112</sup> on 31 May, in Ainderby Steeple, Yorkshire, England.
- 1907**  
 Death of Henry Preston Woods<sup>97</sup> in Nether Kellet, Lancashire, England.
- 1909**  
 Death of Jane Reynolds<sup>98</sup> in March, in Lancashire, United Kingdom.
- 1910**  
 Birth of Whitendale Taylor<sup>64</sup> on 23 May, in Clitheroe, Lancashire.  
 Birth of Margaret Helen Smibert<sup>74</sup> on 9 August, in Middlesex, Ontario, Canada.  
 Birth(?) of Margaret Helen Smibert<sup>74</sup> on 9 August.  
 Birth(?) of Margaret Helen Smibert<sup>74</sup> on 9 August.
- 1911**  
 Marriage of Frederick Blethyn Hulton<sup>83</sup> and Mary Annie Taylor<sup>84</sup> in January, in Bedale, Yorkshire, England.  
 Residence of Margaret Helen Smibert<sup>74</sup> in Middlesex East, Ontario.  
 Birth(?) of Frederick John Hulton<sup>73</sup> on 9 November, in Richmond, Yorkshire North Riding.  
 Birth of Frederick John Hulton<sup>73</sup> in about 1911, in Yorkshire, England.
- 1912**  
 Death of Elizabeth Edwards<sup>100</sup> in January, in Lancashire, United Kingdom.
- 1913**  
 Death of Mary Jennet Robson<sup>96</sup> on 13 February, in Bedale, Yorkshire, England.  
 Birth of Mary Janet Hulton<sup>75</sup> on 21 February, in Northallerton Yorkshire, England.
- 1914**  
 Birth of Margaret (Meg) Hulton<sup>77</sup> on 13 March, in Yorkshire England.
- 1915**  
 Baptism of Ralph William Hulton<sup>79</sup> on 14 July, in Northallerton, Yorkshire, England.  
 Birth of Ralph William Hulton<sup>79</sup> in July, in Northallerton, Yorkshire North Riding, England.
- 1916**  
 Birth of Kitchener Thomas Joseph Gill<sup>78</sup> on 21 May, in Grand Mere, Quebec.
- 1917**  
 Death of John W Taylor<sup>87</sup> on 18 March, in France and Flanders.  
 Birth of Michael A C Hopkins<sup>63</sup> on 12 June, in Liverpool, Merseyside.
- 1920**  
 Marriage of James Anthony Woods<sup>81</sup> and Lucy Ellen Marguerita Parker<sup>82</sup> on 4 February, in St John, Yealand Conyers, Lancashire.
- 1921**  
 Birth of Peter Anthony Woods<sup>60</sup> on 12 March, in Nether Kellet, Lancashire, England.  
 Residence of Frederick John Hulton<sup>73</sup> in Austwick, Yorkshire (West Riding), England.
- 1922**  
 Birth of Elizabeth Helen Woods<sup>62</sup> on 12 December, in Lunesdale, Lancashire.
- 1923**  
 Death of Ruth Coward<sup>102</sup> in December, in Lunesdale, Lancashire, England.

**1924**

Birth of John James Melrose Woods<sup>65</sup> in January, in Lunesdale, Lancashire.  
 Birth of Beatrix Marian Hulton<sup>61</sup> on 3 May, in Chester le Street, Durham.

**1925**

Death of Joseph Parker<sup>101</sup> in March, in Lunesdale, Lancashire, England.  
 Birth of Jean Margaret Woods<sup>67</sup> in April, in Lunesdale, Lancashire.

**1927**

Death of Ralph William Hulton<sup>79</sup> in July, in South Shields, Durham, England.  
 Birth of Barbara M Woods<sup>69</sup> on 9 November, in Lunesdale, Lancashire, England.

**1928**

Birth of Elizabeth Hunt (Libby) Hulton<sup>80</sup> in June, in South Shields, Durham.

**1929**

Departure: Frederick John Hulton<sup>73</sup> on 13 April, in England.  
 Departure: Beatrix Marian Hulton<sup>61</sup> on 3 May, in England.  
 Departure: Elizabeth Hunt (Libby) Hulton<sup>80</sup> on 3 May, in England.  
 Departure: Mary Janet Hulton<sup>75</sup> on 3 May, in England.  
 Departure: Margaret (Meg) Hulton<sup>77</sup> on 3 May, in England.  
 Arrival: Margaret (Meg) Hulton<sup>77</sup>.  
 Arrival: Frederick Blethyn Hulton<sup>83</sup>.  
 Arrival: Mary Janet Hulton<sup>75</sup>.

**1931**

Residence of Beatrix Marian Hulton<sup>61</sup> in Wn, London, Ontario, Canada.  
 Residence of Margaret Helen Smibert<sup>74</sup> in London, Ontario, Canada.  
 Residence of Frederick Blethyn Hulton<sup>83</sup> in Won, London, Ontario, Canada.  
 Residence of Kitchener Thomas Joseph Gill<sup>78</sup> in Champlain, Quebec, Canada.  
 Residence of Margaret (Meg) Hulton<sup>77</sup> in London, Ontario, Canada.  
 Residence of Elizabeth Hunt (Libby) Hulton<sup>80</sup> in WV, London, Ontario, Canada.  
 Residence of Mary Janet Hulton<sup>75</sup> in Wn, London, Ontario, Canada.

**1932**

Death of Peter Melrose<sup>103</sup> on 12 January, in 25 Portland Street, Lancaster, Lancashire, England.

**1934**

Birth of Hazel Walton<sup>72</sup> in January, in Chapel en le Frith, Derbyshire.  
 Death of James Anthony Woods<sup>81</sup> on 11 August, in Nether Kellet, Lancashire, England.  
 Death of Margaret Smailes<sup>104</sup> on 14 December, in 25 Portland Street, Lancaster, Lancashire, England.

**1935**

Birth of Alan Robert Woods<sup>71</sup> on 22 March, in Lancaster, Lancashire.  
 Death of John Benjamin Taylor<sup>95</sup> on 7 May, in Yorkshire, England.  
 Death of James Woods<sup>89</sup> in June, in Lancaster, Lancashire, England.

**1938**

Death of Marian Hunt<sup>94</sup> on 15 April, in Stockton, County Durham, England, United Kingdom.

**1939**

Residence of Alan Robert Woods<sup>71</sup> in Lancashire, England.  
 Residence of Lucy Ellen Marguerita Parker<sup>82</sup> in Lancashire, England.  
 Residence of Peter Anthony Woods<sup>60</sup> in Lancashire, England.  
 Residence of Elizabeth Helen Woods<sup>62</sup> in Lancashire, England.  
 Residence of Barbara M Woods<sup>69</sup> in Lancashire, England.

**1941**

Marriage of Kitchener Thomas Joseph Gill<sup>78</sup> and Margaret (Meg) Hulton<sup>77</sup> on 8 January, in London, Middlesex, Ontario, Canada.

**1942**

Marriage of Michael A C Hopkins<sup>63</sup> and Elizabeth Helen Woods<sup>62</sup> in January, in Lunesdale, Lancashire, United Kingdom.  
 Birth of Michael A E Hopkins<sup>32</sup> in October, in Lunesdale, Lancashire.  
 Marriage of Frederick John Hulton<sup>73</sup> and Margaret Helen Smibert<sup>74</sup> on 26 December, in London, Middlesex, Ontario, Canada.

**1943**

Marriage of George A Saunders<sup>68</sup> and Jean Margaret Woods<sup>67</sup> in July, in Lunesdale, Lancashire, United Kingdom.

**1944**

Death of Michael A E Hopkins<sup>32</sup> in March, in Liverpool North, Lancashire, England.  
 Birth of Gillian Saunders<sup>41</sup> in July, in Birmingham, West Midlands.  
 Birth of Rosemary Hopkins<sup>33</sup> in October, in Liverpool North, Lancashire.  
 Birth of Leonard Stewart Taylor<sup>42</sup> on 7 December.

**1945**

Marriage of Peter Anthony Woods<sup>60</sup> and Beatrix Marian Hulton<sup>61</sup> on 3 May, in Nova Scotia, Canada.  
 Death of Elizabeth Ann Shaw<sup>90</sup> on 3 May, in Lancashire, England.  
 Residence of Frederick John Hulton<sup>73</sup> in Elgin, Ontario, Canada.

- 1946**  
 Birth of Margaret Mackenzie<sup>30</sup> in January, in Preston, Lancashire.  
 Birth of Richard George Woods<sup>29</sup> in April, in Lancaster, Lancashire.  
 Marriage of Robert (Roy) J Graham<sup>70</sup> and Barbara M Woods<sup>69</sup> in July, in Lunesdale, Lancashire, United Kingdom.
- 1947**  
 Birth of James William Hulton<sup>52</sup> on 9 February, in Ontario.  
 Death of James William Hulton<sup>52</sup> on 13 February, in Tillsonburg, Oxford, Ontario, Canada.
- 1949**  
 Marriage of John James Melrose Woods<sup>65</sup> in July, in Lunesdale, Lancashire, United Kingdom.  
 Birth of Peter John Woods<sup>31</sup> in September, in Amounderness, Lancashire.
- 1950**  
 Birth of Patricia Hulton<sup>53</sup> on 24 June.
- 1951**  
 Death of Jane Ellen Archbold Smailes Melrose<sup>92</sup> on 17 March, in Daisyfield, Green Lane, Lancaster, Lancashire, England.
- 1952**  
 Birth of Andrew John Jameson<sup>28</sup> on 5 April.
- 1953**  
 Marriage of Whitendale Taylor<sup>64</sup> and Elizabeth Helen Woods<sup>62</sup> in October, in Lunesdale, Lancashire, United Kingdom.
- 1954**  
 Death of Henry Parker<sup>91</sup> in October, in Preston, Lancashire, England.
- 1955**  
 Birth of Judy Sopher<sup>51</sup> on 7 June.
- 1957**  
 Birth of Martin Craig Watts<sup>27</sup> on 4 April.  
 Birth of David Taylor<sup>35</sup> in April, in Lunesdale, Lancashire.  
 Birth of Jane Elizabeth Woods<sup>26</sup> on 25 May, in Preston, Lancashire, England.
- 1958**  
 Marriage of Alan Robert Woods<sup>71</sup> and Hazel Walton<sup>72</sup> in April, in Chapel en le Frith, Derbyshire, United Kingdom.  
 Death of Frederick Blethyn Hulton<sup>83</sup> in Ontario, Canada.
- 1959**  
 Birth of Nerys Woods<sup>47</sup> in April, in Wrexham, Denbighshire.  
 Birth of John A Taylor<sup>37</sup> in October, in Lancaster, Lancashire.
- 1960**  
 Birth of Margaret M Swarbrick<sup>38</sup> on 27 April.
- 1961**  
 Death of Elizabeth Helen Woods<sup>62</sup> in April, in Lancaster, Lancashire, England.  
 Death of Norah Taylor<sup>88</sup> in December, in Northallerton, Yorkshire North Riding, England.
- 1964**  
 Marriage of Thomas B Logue<sup>34</sup> and Rosemary Hopkins<sup>33</sup> in July, in Lancaster, Lancashire, United Kingdom.  
 Death of Whitendale Taylor<sup>64</sup> in July, in Preston, Lancashire, England.
- 1965**  
 Birth of Michael A Logue<sup>10</sup> in July, in Lancaster, Lancashire.
- 1966**  
 Death of Janet Isabel Taylor<sup>85</sup> in December, in Northallerton, Yorkshire North Riding, England.
- 1967**  
 Birth of Amanda Helen Woods<sup>48</sup> in January, in Stockport, Cheshire.  
 Marriage of Leonard Stewart Taylor<sup>42</sup> and Gillian Saunders<sup>41</sup> in April, in Lunesdale, Lancashire, United Kingdom.  
 Birth of Helen Josephine Logue<sup>11</sup> in April, in Lancaster, Lancashire.  
 Marriage of Richard George Woods<sup>29</sup> and Margaret Mackenzie<sup>30</sup> in July, in Amounderness, Lancashire, United Kingdom.
- 1968**  
 Birth of Jennifer Clare Woods<sup>4</sup> in January, in Preston, Lancashire.  
 Birth of Catherine Alice Logue<sup>12</sup> in April, in Lancaster, Lancashire.  
 Birth of Chris Heslop<sup>16</sup> on 7 August.
- 1969**  
 Death of John James Melrose Woods<sup>65</sup> on 2 January, in Lancaster.  
 Birth of Alastair Richard Woods<sup>6</sup> in January, in Amounderness, Lancashire.  
 Probate: John James Melrose Woods<sup>65</sup> on 11 April, in Lancaster.
- 1970**  
 Birth of Simon Andrew Woods<sup>8</sup> in April.
- 1972**  
 Wedding announcement: Brian Joseph Gill<sup>58</sup> on 25 February, in Montreal, Quebec, Canada.
- 1975**  
 Residence of Mary Janet Hulton<sup>75</sup> in Florida.

- 1976**  
Death of Lucy Ellen Marguerita Parker<sup>82</sup> on 22 October, in Charnley Fold House, Bamber Bridge, Preston, Lancashire, England.
- 1977**  
Death of Kitchener Thomas Joseph Gill<sup>78</sup> on 1 December, in London, Ontario.  
Obituary for GILL Kitchener: Kitchener Thomas Joseph Gill<sup>78</sup> on 3 December, in Montreal, Quebec, Canada.  
Obituary for GILL Kitchener: Kitchener Thomas Joseph Gill<sup>78</sup> on 3 December, in Montreal, Quebec, Canada.  
Birth of Sean Anderson<sup>25</sup> on 29 December.
- 1978**  
Death of Mary Annie Taylor<sup>84</sup> on 7 April, in Ontario, Canada.
- 1979**  
Marriage of Martin Craig Watts<sup>27</sup> and Jane Elizabeth Woods<sup>26</sup> in August, in Preston and Ribble, Lancashire, United Kingdom.
- 1984**  
Marriage of John A Taylor<sup>37</sup> and Margaret M Swarbrick<sup>38</sup> in Garstang, Lancashire, United Kingdom.
- 1986**  
Marriage of David Taylor<sup>35</sup> and Veronica Ann Cairns<sup>36</sup> in Lancaster, Lancashire, United Kingdom.
- 1987**  
Marriage of Sean P McDonald<sup>49</sup> and Amanda Helen Woods<sup>48</sup> in High Peak, Derbyshire, United Kingdom.
- 1988**  
Birth of Robert Taylor<sup>13</sup> in July, in Lancaster, Lancashire.  
Birth of James William Taylor<sup>17</sup> on 5 September.
- 1989**  
Birth of Michael Lee Slack<sup>3</sup> on 3 March, in Sutton In Ashfield, Nottinghamshire, England.
- 1990**  
Birth of Rachel Jane Watts<sup>2</sup> on 24 March.
- 1991**  
Birth of Lynne Margaret Taylor<sup>18</sup> in February, in Lancaster, Lancashire.
- 1992**  
Birth of Jennifer Taylor<sup>15</sup> in April, in Lancaster, Lancashire.  
Birth of Georgina Audrey Lister<sup>19</sup> in August, in Lancaster, Lancashire.
- 1996**  
Death of Martin Craig Watts<sup>27</sup> on 26 August, in Preston and South Ribble, Lancashire, England.  
Burial of Martin Craig Watts<sup>27</sup> on 6 September, in Cambridgeshire, England.
- 1997**  
Birth of Callum Sean McDonald<sup>20</sup> in September, in Stockport, Cheshire.  
Birth of Connor Alan McDonald<sup>21</sup> in September, in Stockport, Cheshire.
- 1998**  
Death of Frederick John Hulton<sup>73</sup> in Parry Sound.  
Death of George A Saunders<sup>68</sup>.
- 2000**  
Death of Mary Janet Hulton<sup>75</sup> on 3 March, in Florida.
- 2001**  
Death of Jean Margaret Woods<sup>67</sup> in November.
- 2004**  
Death of Elizabeth Hunt (Libby) Hulton<sup>80</sup> in Ontario, Canada.
- 2005**  
Birth of Connor Woods<sup>1</sup> in February.
- 2006**  
Death of Margaret Helen Smibert<sup>74</sup> on 16 November, in Beeton, Ontario, Canada.  
Death(?) of Margaret Helen Smibert<sup>74</sup> on 16 November.
- 2007**  
Death of Peter Anthony Woods<sup>60</sup> on 29 May, in Preston.
- 2008**  
Death of Beatrix Marian Hulton<sup>61</sup> on 13 September, in Preston, Lancashire, England, United Kingdom.
- 2012**  
Residence of Alastair Richard Woods<sup>6</sup> in Mitcham, Surrey, England.
- 2013**  
Death of Alan Robert Woods<sup>71</sup> on 15 February.
- 2014**  
Death of Margaret (Meg) Hulton<sup>77</sup> on 20 February, in Canada.  
Obituary for Margaret GILL: Margaret (Meg) Hulton<sup>77</sup> on 25 February, in Montreal, Quebec, Canada.
- 2015**  
Marriage of Chris Heslop<sup>16</sup> and Jennifer Taylor<sup>15</sup> on 15 August.
- 2018**  
Residence of Amanda Helen Woods<sup>48</sup> in Preston, Derbyshire, England.

- 2020**  
Death of Jack Anderson<sup>54</sup> in November.
- 2022**  
Marriage of David Rowson<sup>5</sup> and Jennifer Clare Woods<sup>4</sup> in January, in Durham County, North Carolina, USA.
- 2024**  
Death of Jane Elizabeth Woods<sup>26</sup> on 27 September, in Alyth, Perthshire, Scotland.

## 9. INDEX OF ANNIVERSARIES

### **JANUARY**

2. Death of John James Melrose Woods<sup>65</sup> in Lancaster, in 1969
8. Marriage of Kitchener Thomas Joseph Gill<sup>78</sup> and Margaret (Meg) Hulton<sup>77</sup> in London, Middlesex, Ontario, Canada, in 1941
10. Birth of Charles Norleigh Hulton<sup>105</sup> in Deane, Lancashire, England, in 1823
12. Death of Peter Melrose<sup>703</sup> in 25 Portland Street, Lancaster, Lancashire, England, in 1932
25. Birth of Jane Reynolds<sup>98</sup> in St Michael's, Lancashire, England, in 1825
- Marriage of Charles Norleigh Hulton<sup>105</sup> in Stokesley, Yorkshire North Riding, in 1844
- Death of Anthony Shaw<sup>99</sup> in Lunesdale, Lancashire, England, in 1882
- Death of Elizabeth Willis<sup>108</sup> in Stockport, Cheshire, in 1892
- Marriage of Frederick Blethyn Hulton<sup>83</sup> and Mary Annie Taylor<sup>84</sup> in Bedale, Yorkshire, England, in 1911
- Death of Elizabeth Edwards<sup>700</sup> in Lancashire, United Kingdom, in 1912
- Birth of John James Melrose Woods<sup>65</sup> in Lunesdale, Lancashire, in 1924
- Birth of Hazel Walton<sup>72</sup> in Chapel en le Frith, Derbyshire, in 1934
- Marriage of Michael A C Hopkins<sup>63</sup> and Elizabeth Helen Woods<sup>62</sup> in Lunesdale, Lancashire, United Kingdom, in 1942
- Birth of Margaret Mackenzie<sup>30</sup> in Preston, Lancashire, in 1946
- Birth of Amanda Helen Woods<sup>48</sup> in Stockport, Cheshire, in 1967
- Birth of Jennifer Clare Woods<sup>4</sup> in Preston, Lancashire, in 1968
- Birth of Alastair Richard Woods<sup>6</sup> in Amounderness, Lancashire, in 1969
- Marriage of David Rowson<sup>5</sup> and Jennifer Clare Woods<sup>4</sup> in Durham County, North Carolina, USA, in 2022

### **FEBRUARY**

4. Birth of Adam Hulton<sup>130</sup> in Of Hulton Park, in 1557
- Birth of Ruth Coward<sup>102</sup> in Halton with Aughton Lancashire, England, in 1850
- Marriage of James Anthony Woods<sup>81</sup> and Lucy Ellen Marguerita Parker<sup>82</sup> in St John, Yealand Conyers, Lancashire, in 1920
5. Death of Clemence Norris<sup>135</sup> in Hulton Hall, Hulton Park, Hulton, Lancashire, England, in 1595
9. Birth of James William Hulton<sup>52</sup> in Ontario, in 1947
13. Death of Adam Hulton<sup>138</sup> in Hulton Park, Over Hulton, Bolton, Deane, Lancashire, England, in 1530
- Death of Mary Jennet Robson<sup>96</sup> in Bedale, Yorkshire, England, in 1913
- Death of James William Hulton<sup>52</sup> in Tillsonburg, Oxford, Ontario, Canada, in 1947
14. Marriage of Peter Melrose<sup>103</sup> and Margaret Smailes<sup>104</sup> in Newcastle Cathedral, Newcastle Upon Tyne, Northumberland, England, in 1875
15. Death of Alan Robert Woods<sup>71</sup>, in 2013
20. Death of Margaret (Meg) Hulton<sup>77</sup> in Canada, in 2014
21. Birth of Mary Janet Hulton<sup>75</sup> in Northallerton Yorkshire, England, in 1913
25. Wedding announcement: Brian Joseph Gill<sup>58</sup> in Montreal, Quebec, Canada, in 1972
- Obituary for Margaret GILL: Margaret (Meg) Hulton<sup>77</sup> in Montreal, Quebec, Canada, in 2014
- Birth of Lynne Margaret Taylor<sup>18</sup> in Lancaster, Lancashire, in 1991
- Birth of Connor Woods<sup>1</sup>, in 2005

### **MARCH**

2. Death of Charles Norleigh Hulton<sup>105</sup> in Altona, Börde, Saxony-Anhalt, Germany, in 1870
3. Birth of Michael Lee Slack<sup>3</sup> in Sutton In Ashfield, Nottinghamshire, England, in 1989
- Death of Mary Janet Hulton<sup>75</sup> in Florida, in 2000
12. Birth of Peter Anthony Woods<sup>60</sup> in Nether Kellet, Lancashire, England, in 1921
13. Marriage of Charles Norleigh Hulton<sup>105</sup> and Mary Ann Watson<sup>106</sup> in Stokesley, York, England, in 1844
- Birth of Margaret (Meg) Hulton<sup>77</sup> in Yorkshire England, in 1914
17. Death of Jane Ellen Archbold Smailes Melrose<sup>92</sup> in Daisyfield, Green Lane, Lancaster, Lancashire, England, in 1951
18. Death of John W Taylor<sup>87</sup> in France and Flanders, in 1917
22. Birth of Alan Robert Woods<sup>71</sup> in Lancaster, Lancashire, in 1935
24. Birth of Rachel Jane Watts<sup>2</sup>, in 1990
28. Birth of Elizabeth Willis<sup>108</sup> in Lancashire, England, in 1813
31. Death of William Hulton<sup>113</sup> in Leamington Spa, Warwickshire, England, in 1864
- Death of Jane Reynolds<sup>98</sup> in Lancashire, United Kingdom, in 1909
- Death of Joseph Parker<sup>101</sup> in Lunesdale, Lancashire, England, in 1925
- Death of Michael A E Hopkins<sup>32</sup> in Liverpool North, Lancashire, England, in 1944

**APRIL**

4. Birth of Martin Craig Watts<sup>27</sup>, in 1957
5. Death of Maria Randle Ford<sup>114</sup> in Warwick, Warwickshire, in 1866  
Birth of Andrew John Jameson<sup>28</sup>, in 1952
6. Birth of Peter Melrose<sup>103</sup> in Glensax, Peebles, Peeblesshire, Scotland, in 1851
7. Death of Mary Annie Taylor<sup>84</sup> in Ontario, Canada, in 1978
11. Probate: John James Melrose Woods<sup>65</sup> in Lancaster, in 1969
13. Departure: Frederick John Hulton<sup>73</sup> in England, in 1929
15. Death of William Robson<sup>111</sup> in Ainderby Steeple, Yorkshire, England, in 1896  
Death of Marian Hunt<sup>94</sup> in Stockton, County Durham, England, United Kingdom, in 1938
23. Birth of Jane Ellen Archbold Smailes Melrose<sup>92</sup> in Craster, North Side, Dunstan, Embleton, Northumberland, England, in 1875  
Marriage of William Ford Ralph Hulton<sup>93</sup> and Marian Hunt<sup>94</sup> in Saint Mary, Disley, Cheshire, England, United Kingdom, in 1878
27. Birth of Margaret M Swarbrick<sup>38</sup>, in 1960  
Death of William Hulton<sup>120</sup> in Hulton Park, Over Hulton, Lancashire, in 1741  
Death of John Taylor<sup>109</sup> in Northallerton, Yorkshire North Riding, in 1894  
Birth of Jean Margaret Woods<sup>67</sup> in Lunesdale, Lancashire, in 1925  
Birth of Richard George Woods<sup>29</sup> in Lancaster, Lancashire, in 1946  
Birth of David Taylor<sup>35</sup> in Lunesdale, Lancashire, in 1957  
Marriage of Alan Robert Woods<sup>71</sup> and Hazel Walton<sup>72</sup> in Chapel en le Frith, Derbyshire, United Kingdom, in 1958  
Birth of Nerys Woods<sup>47</sup> in Wrexham, Denbighshire, in 1959  
Death of Elizabeth Helen Woods<sup>62</sup> in Lancaster, Lancashire, England, in 1961  
Marriage of Leonard Stewart Taylor<sup>42</sup> and Gillian Saunders<sup>41</sup> in Lunesdale, Lancashire, United Kingdom, in 1967  
Birth of Helen Josephine Logue<sup>11</sup> in Lancaster, Lancashire, in 1967  
Birth of Catherine Alice Logue<sup>12</sup> in Lancaster, Lancashire, in 1968  
Birth of Simon Andrew Woods<sup>8</sup>, in 1970  
Birth of Jennifer Taylor<sup>15</sup> in Lancaster, Lancashire, in 1992

**MAY**

3. Birth of Marian Hunt<sup>94</sup> in Manchester, Lancashire, England, in 1848  
Birth of Beatrix Marian Hulton<sup>61</sup> in Chester le Street, Durham, in 1924  
Departure: Margaret (Meg) Hulton<sup>77</sup> in England, in 1929  
Departure: Mary Janet Hulton<sup>75</sup> in England, in 1929  
Departure: Elizabeth Hunt (Libby) Hulton<sup>80</sup> in England, in 1929  
Departure: Beatrix Marian Hulton<sup>61</sup> in England, in 1929  
Marriage of Peter Anthony Woods<sup>60</sup> and Beatrix Marian Hulton<sup>61</sup> in Nova Scotia, Canada, in 1945  
Death of Elizabeth Ann Shaw<sup>90</sup> in Lancashire, England, in 1945
4. Birth of Mary Annie Taylor<sup>84</sup> in Bedale, Yorkshire North Riding, England, in 1886
7. Marriage of William Tyrrell Boyce<sup>117</sup> and Jane Langford Brooke<sup>116</sup> in Deane, Lancashire, England, in 1804  
Death of John Benjamin Taylor<sup>95</sup> in Yorkshire, England, in 1935
16. Death of William Ford Ralph Hulton<sup>93</sup> in Dover, Kent, England, in 1898
21. Birth of Kitchener Thomas Joseph Gill<sup>78</sup> in Grand Mere, Quebec, in 1916
23. Birth of Whitendale Taylor<sup>64</sup> in Clitheroe, Lancashire, in 1910
25. Birth of Jane Elizabeth Woods<sup>26</sup> in Preston, Lancashire, England, in 1957
27. Death of William Hulton<sup>124</sup> in Hulton Hall, Hulton Park, Over Hulton, Deane, Lancashire, England, in 1694
28. Birth of William Hulton<sup>115</sup>, in 1762
29. Death of Peter Anthony Woods<sup>60</sup> in Preston, in 2007
31. Death of Jennet Mackay<sup>112</sup> in Ainderby Steeple, Yorkshire, England, in 1905  
Marriage of Adam Hulton<sup>138</sup> and Alicia Hulton<sup>139</sup>, in 1489

**JUNE**

7. Birth of Judy Sopher<sup>51</sup>, in 1955
9. Birth of Margaret Smailes<sup>104</sup> in Craster, Northumberland, England, in 1852
12. Marriage of Richard Thomas Hunt<sup>107</sup> and Elizabeth Willis<sup>108</sup> in Lancaster, St Mary, Lancashire, England, United Kingdom, in 1838  
Marriage of Henry Parker<sup>91</sup> and Jane Ellen Archbold Smailes Melrose<sup>92</sup> in Lancaster Priory, St Mary, Lancashire, England, in 1897  
Birth of Michael A C Hopkins<sup>63</sup> in Liverpool, Merseyside, in 1917
22. Birth of William Hulton<sup>120</sup> in Hulton Park, Over Hulton, Lancashire, in 1717
24. Death of William Hulton<sup>115</sup>, in 1800

**JUNE (Continued)**

- 24. Birth of Patricia Hulton<sup>53</sup>, in 1950
- 27. Death of Mary Ann Watson<sup>106</sup> in Durham, England, in 1855
- Birth of William Robson<sup>111</sup> in Ainderby Steeple, Yorkshire, England, in 1821
- Birth of Elizabeth Hunt (Libby) Hulton<sup>80</sup> in South Shields, Durham, in 1928
- Death of James Woods<sup>89</sup> in Lancaster, Lancashire, England, in 1935

**JULY**

- 1. Birth of Adam Hulton<sup>126</sup> in Hulton Park, (Deane), Lancashire, England, United Kingdom, in 1607
- 6. Death of Mary Haseldean<sup>123</sup> in Deane-By-Bolton, Lancashire, England, in 1726
- Birth of Frederick Blethyn Hulton<sup>83</sup> in Seaton Carew, Durham, England, in 1886
- 7. Birth of John Benjamin Taylor<sup>95</sup> in Upsall, Yorkshire, England, in 1855
- 14. Baptism of Ralph William Hulton<sup>79</sup> in Northallerton, Yorkshire, England, in 1915
- 21. Birth of Joseph Parker<sup>101</sup> in 6 Moor Lane, Lancaster, Lancashire, England, in 1841
- Death of William Tyrrell Boyce<sup>117</sup> in Calais, France, in 1838
- Death of Mary Atlay<sup>110</sup> in Northallerton, Yorkshire North Riding, in 1884
- Birth of Ralph William Hulton<sup>79</sup> in Northallerton, Yorkshire North Riding, England, in 1915
- Death of Ralph William Hulton<sup>79</sup> in South Shields, Durham, England, in 1927
- Marriage of George A Saunders<sup>68</sup> and Jean Margaret Woods<sup>67</sup> in Lunesdale, Lancashire, United Kingdom, in 1943
- Birth of Gillian Saunders<sup>41</sup> in Birmingham, West Midlands, in 1944
- Marriage of Robert (Roy) J Graham<sup>70</sup> and Barbara M Woods<sup>69</sup> in Lunesdale, Lancashire, United Kingdom, in 1946
- Marriage of John James Melrose Woods<sup>65</sup> in Lunesdale, Lancashire, United Kingdom, in 1949
- Marriage of Thomas B Logue<sup>34</sup> and Rosemary Hopkins<sup>33</sup> in Lancaster, Lancashire, United Kingdom, in 1964
- Death of Whitendale Taylor<sup>64</sup> in Preston, Lancashire, England, in 1964
- Birth of Michael A Logue<sup>10</sup> in Lancaster, Lancashire, in 1965
- Marriage of Richard George Woods<sup>29</sup> and Margaret Mackenzie<sup>30</sup> in Amounderness, Lancashire, United Kingdom, in 1967
- Birth of Robert Taylor<sup>13</sup> in Lancaster, Lancashire, in 1988

**AUGUST**

- 7. Birth of Jane Langford Brooke<sup>116</sup> in Rostherne, Cheshire, England, in 1764
- Birth of Chris Heslop<sup>16</sup>, in 1968
- 9. Birth of Margaret Helen Smibert<sup>74</sup> in Middlesex, Ontario, Canada, in 1910
- Birth(?) of Margaret Helen Smibert<sup>74</sup>, in 1910
- Birth(?) of Margaret Helen Smibert<sup>74</sup>, in 1910
- 11. Death of James Anthony Woods<sup>81</sup> in Nether Kellet, Lancashire, England, in 1934
- 15. Marriage of Chris Heslop<sup>16</sup> and Jennifer Taylor<sup>15</sup>, in 2015
- 18. Death of William (The Patriarch) Hulton<sup>132</sup> in Hulton Park, Over Hulton, Westhoughton, Bolton, Deane, Lancashire, England, in 1624
- 23. Marriage of William Hulton<sup>115</sup> and Jane Langford Brooke<sup>116</sup> in Rostherne, Cheshire, England, in 1785
- 26. Death of Martin Craig Watts<sup>27</sup> in Preston and South Ribble, Lancashire, England, in 1996
- 28. Birth of Mary Jennet Robson<sup>96</sup> in Ainderby Steeple, Yorkshire, England, in 1861
- Marriage of Martin Craig Watts<sup>27</sup> and Jane Elizabeth Woods<sup>26</sup> in Preston and Ribble, Lancashire, United Kingdom, in 1979
- Birth of Georgina Audrey Lister<sup>19</sup> in Lancaster, Lancashire, in 1992

**SEPTEMBER**

- 3. Birth of Henry Parker<sup>91</sup> in Hayshaw Farm, Scorton, Wyresdale, Lancashire, England, in 1875
- 5. Birth of James William Taylor<sup>17</sup>, in 1988
- 6. Death of William Hulton<sup>128</sup>, in 1613
- Burial of Martin Craig Watts<sup>27</sup> in Cambridgeshire, England, in 1996
- 9. Birth of William Hulton<sup>124</sup> in Hulton Hall, Hulton Park, Over Hulton, Deane, Lancashire, England, in 1625
- 13. Death of Beatrix Marian Hulton<sup>61</sup> in Preston, Lancashire, England, United Kingdom, in 2008
- 16. Death of Adam Hulton<sup>126</sup> in Hulton Park, (16)(Deane), Lancashire, England, United Kingdom, in 1651
- 22. Death of Richard Thomas Hunt<sup>107</sup> in Cheshire, England, in 1874
- 24. Birth of Lucy Ellen Marguerita Parker<sup>82</sup> in The Shooting Box, Abbystead, Wyresdale, Lancashire, England, in 1897
- 27. Death of Jane Elizabeth Woods<sup>26</sup> in Alyth, Perthshire, Scotland, in 2024
- 29. Death of Adam Hulton<sup>134</sup> in Hulton Hall, Hulton Park, Over Hulton, Deane, Lancashire, England, in 1573
- 30. Birth of Richard Thomas Hunt<sup>107</sup> in Burford, Oxfordshire, England, in 1802
- Birth of William Ford Ralph Hulton<sup>93</sup> in Stokesley, Hambleton District, North Yorkshire, England, in 1848

**SEPTEMBER (Continued)**

- Marriage of John Taylor<sup>109</sup> and Mary Atlay<sup>110</sup> in Thirsk, Yorkshire - North Riding, in 1852
- Birth of Peter John Woods<sup>31</sup> in Amounderness, Lancashire, in 1949
- Birth of Callum Sean McDonald<sup>20</sup> in Stockport, Cheshire, in 1997
- Birth of Connor Alan McDonald<sup>21</sup> in Stockport, Cheshire, in 1997

**OCTOBER**

- 6. Birth of William Hulton<sup>118</sup> in Hulton Park, Cheshire, England, in 1739
- 20. Birth of Anthony Shaw<sup>99</sup> in Quernmore, Lancashire, England, in 1832
- 21. Birth of Elizabeth Ann Shaw<sup>90</sup> in Caton, Lancashire, England, in 1865
- 22. Death of Lucy Ellen Marguerita Parker<sup>82</sup> in Charnley Fold House, Bamber Bridge, Preston, Lancashire, England, in 1976
- 23. Birth of William Hulton<sup>113</sup> in Over Hulton, Lancashire, England, in 1787
- 24. Birth of William Tyrrell Boyce<sup>117</sup> in Croydon, Surrey, in 1780
- 25. Marriage of William Hulton<sup>113</sup> and Maria Randle Ford<sup>114</sup> in Wexham, Buckingham, England, in 1808
- Birth of Michael A E Hopkins<sup>32</sup> in Lunesdale, Lancashire, in 1942
- Birth of Rosemary Hopkins<sup>33</sup> in Liverpool North, Lancashire, in 1944
- Marriage of Whitendale Taylor<sup>64</sup> and Elizabeth Helen Woods<sup>62</sup> in Lunesdale, Lancashire, United Kingdom, in 1953
- Death of Henry Parker<sup>91</sup> in Preston, Lancashire, England, in 1954
- Birth of John A Taylor<sup>37</sup> in Lancaster, Lancashire, in 1959

**NOVEMBER**

- 6. Birth of Janet Isabel Taylor<sup>85</sup> in Bedale, Yorkshire North Riding, in 1887
- 9. Birth(?) of Frederick John Hulton<sup>73</sup> in Richmond, Yorkshire North Riding, in 1911
- Birth of Barbara M Woods<sup>69</sup> in Lunesdale, Lancashire, England, in 1927
- 16. Death of Margaret Helen Smibert<sup>74</sup> in Beeton, Ontario, Canada, in 2006
- Death(?) of Margaret Helen Smibert<sup>74</sup>, in 2006
- Marriage of Adam Hulton<sup>134</sup> and Clemence Norris<sup>135</sup>, in 1534
- Death of Jean Margaret Woods<sup>67</sup>, in 2001
- Death of Jack Anderson<sup>54</sup>, in 2020

**DECEMBER**

- 1. Death of Kitchener Thomas Joseph Gill<sup>78</sup> in London, Ontario, in 1977
- 3. Obituary for GILL Kitchener: Kitchener Thomas Joseph Gill<sup>78</sup> in Montreal, Quebec, Canada, in 1977
- Obituary for GILL Kitchener: Kitchener Thomas Joseph Gill<sup>78</sup> in Montreal, Quebec, Canada, in 1977
- 7. Death of Jane Langford Brooke<sup>116</sup> in Marylebone, Middlesex, England, in 1845
- Birth of Leonard Stewart Taylor<sup>42</sup>, in 1944
- 12. Birth of Elizabeth Helen Woods<sup>62</sup> in Lunesdale, Lancashire, in 1922
- 14. Death of Margaret Smailes<sup>104</sup> in 25 Portland Street, Lancaster, Lancashire, England, in 1934
- 16. Death of Anne Jessop<sup>125</sup> in Hulton Hall, Hulton Park, Over Hulton, Deane, Lancashire, England, in 1677
- 26. Marriage of Frederick John Hulton<sup>73</sup> and Margaret Helen Smibert<sup>74</sup> in London, Middlesex, Ontario, Canada, in 1942
- 29. Death of Adam Hulton<sup>130</sup> in Deane, Lancashire, England, in 1597
- Birth of Sean Anderson<sup>25</sup>, in 1977
- Death of Ruth Coward<sup>102</sup> in Lunesdale, Lancashire, England, in 1923
- Death of Norah Taylor<sup>88</sup> in Northallerton, Yorkshire North Riding, England, in 1961
- Death of Janet Isabel Taylor<sup>85</sup> in Northallerton, Yorkshire North Riding, England, in 1966

## 10. RELATIONSHIP PATHS

This section details the relationship of each connected individual to Jane Elizabeth Woods.

To facilitate cross-referencing, the relationship reference number in this section is shown with the relationship description within the other sections.

### **IMMEDIATE FAMILY**

1. PETER ANTHONY WOODS<sup>60</sup>. Father
2. BEATRIX MARIAN HULTON<sup>61</sup>. Mother
3. RICHARD GEORGE WOODS<sup>29</sup>. Brother
4. PETER JOHN WOODS<sup>31</sup>. Brother
5. ANDREW JOHN JAMESON<sup>28</sup>. Husband
6. MARTIN CRAIG WATTS<sup>27</sup>. Husband
7. RACHEL JANE WATTS<sup>2</sup>. Daughter

### **1 STEP REMOVED**

8. JAMES ANTHONY WOODS<sup>81</sup>. Father of Peter Anthony Woods, father
9. LUCY ELLEN MARGUERITA PARKER<sup>82</sup>. Mother of Peter Anthony Woods, father
10. ALAN ROBERT WOODS<sup>71</sup>. Brother of Peter Anthony Woods, father
11. JOHN JAMES MELROSE WOODS<sup>65</sup>. Brother of Peter Anthony Woods, father
12. JEAN MARGARET WOODS<sup>67</sup>. Sister of Peter Anthony Woods, father
13. ELIZABETH HELEN WOODS<sup>62</sup>. Sister of Peter Anthony Woods, father
14. BARBARA M WOODS<sup>69</sup>. Sister of Peter Anthony Woods, father
15. FREDERICK BLETHYN HULTON<sup>83</sup>. Father of Beatrix Marian Hulton, mother
16. MARY ANNIE TAYLOR<sup>84</sup>. Mother of Beatrix Marian Hulton, mother
17. FREDERICK JOHN HULTON<sup>73</sup>. Brother of Beatrix Marian Hulton, mother
18. RALPH WILLIAM HULTON<sup>79</sup>. Brother of Beatrix Marian Hulton, mother
19. ELIZABETH HUNT (LIBBY) HULTON<sup>80</sup>. Sister of Beatrix Marian Hulton, mother
20. MARY JANET HULTON<sup>75</sup>. Sister of Beatrix Marian Hulton, mother
21. MARGARET (MEG) HULTON<sup>77</sup>. Sister of Beatrix Marian Hulton, mother
22. MARGARET MACKENZIE<sup>30</sup>. Wife of Richard George Woods, brother
23. SIMON ANDREW WOODS<sup>8</sup>. Son of Richard George Woods, brother
24. ALASTAIR RICHARD WOODS<sup>6</sup>. Son of Richard George Woods, brother
25. JENNIFER CLARE WOODS<sup>4</sup>. Daughter of Richard George Woods, brother
26. MICHAEL LEE SLACK<sup>3</sup>. Husband of Rachel Jane Watts, daughter

### **2 STEPS REMOVED**

27. JAMES WOODS<sup>89</sup>. Father of James Anthony Woods, father of Peter Anthony Woods, father
28. ELIZABETH ANN SHAW<sup>90</sup>. Mother of James Anthony Woods, father of Peter Anthony Woods, father
29. HENRY PARKER<sup>91</sup>. Father of Lucy Ellen Marguerita Parker, mother of Peter Anthony Woods, father
30. JANE ELLEN ARCHBOLD SMAILES MELROSE<sup>92</sup>. Mother of Lucy Ellen Marguerita Parker, mother of Peter Anthony Woods, father
31. HAZEL WALTON<sup>72</sup>. Wife of Alan Robert Woods, brother of Peter Anthony Woods, father
32. MARY PRICE<sup>66</sup>. Wife of John James Melrose Woods, brother of Peter Anthony Woods, father
33. PAULA WOODS<sup>46</sup>. Daughter of Alan Robert Woods, brother of Peter Anthony Woods, father
34. NERYS WOODS<sup>47</sup>. Daughter of Alan Robert Woods, brother of Peter Anthony Woods, father
35. AMANDA HELEN WOODS<sup>48</sup>. Daughter of Alan Robert Woods, brother of Peter Anthony Woods, father
36. ROBERT (ROY) J GRAHAM<sup>70</sup>. Husband of Barbara M Woods, sister of Peter Anthony Woods, father
37. MICHAEL A C HOPKINS<sup>63</sup>. Husband of Elizabeth Helen Woods, sister of Peter Anthony Woods, father
38. GEORGE A SAUNDERS<sup>68</sup>. Husband of Jean Margaret Woods, sister of Peter Anthony Woods, father
39. WHITENDALE TAYLOR<sup>64</sup>. Husband of Elizabeth Helen Woods, sister of Peter Anthony Woods, father
40. DAVID TAYLOR<sup>35</sup>. Son of Elizabeth Helen Woods, sister of Peter Anthony Woods, father
41. JOHN A TAYLOR<sup>37</sup>. Son of Elizabeth Helen Woods, sister of Peter Anthony Woods, father
42. STUART GRAHAM<sup>45</sup>. Son of Barbara M Woods, sister of Peter Anthony Woods, father
43. MICHAEL A E HOPKINS<sup>32</sup>. Son of Elizabeth Helen Woods, sister of Peter Anthony Woods, father
44. ROSEMARY HOPKINS<sup>33</sup>. Daughter of Elizabeth Helen Woods, sister of Peter Anthony Woods, father
45. GAIL SAUNDERS<sup>39</sup>. Daughter of Jean Margaret Woods, sister of Peter Anthony Woods, father
46. KATHLEEN GRAHAM<sup>43</sup>. Daughter of Barbara M Woods, sister of Peter Anthony Woods, father
47. GILLIAN SAUNDERS<sup>41</sup>. Daughter of Jean Margaret Woods, sister of Peter Anthony Woods, father
48. WILLIAM FORD RALPH HULTON<sup>93</sup>. Father of Frederick Blethyn Hulton, father of Beatrix Marian Hulton, mother
49. MARIAN HUNT<sup>94</sup>. Mother of Frederick Blethyn Hulton, father of Beatrix Marian Hulton, mother
50. JOHN BENJAMIN TAYLOR<sup>95</sup>. Father of Mary Annie Taylor, mother of Beatrix Marian Hulton, mother
51. MARY JENNET ROBSON<sup>96</sup>. Mother of Mary Annie Taylor, mother of Beatrix Marian Hulton, mother
52. JOHN W TAYLOR<sup>87</sup>. Brother of Mary Annie Taylor, mother of Beatrix Marian Hulton, mother
53. JANET ISABEL TAYLOR<sup>85</sup>. Sister of Mary Annie Taylor, mother of Beatrix Marian Hulton, mother

**2 STEPS REMOVED (Continued)**

54. ALICE M TAYLOR<sup>86</sup>. Sister of Mary Annie Taylor, mother of Beatrix Marian Hulton, mother  
 55. NORAH TAYLOR<sup>88</sup>. Sister of Mary Annie Taylor, mother of Beatrix Marian Hulton, mother  
 56. MARGARET HELEN SMIBERT<sup>74</sup>. Wife of Frederick John Hulton, brother of Beatrix Marian Hulton, mother  
 57. MR. HULTON<sup>50</sup>. Son of Frederick John Hulton, brother of Beatrix Marian Hulton, mother  
 58. JAMES WILLIAM HULTON<sup>52</sup>. Son of Frederick John Hulton, brother of Beatrix Marian Hulton, mother  
 59. PATRICIA HULTON<sup>53</sup>. Daughter of Frederick John Hulton, brother of Beatrix Marian Hulton, mother  
 60. MR. BOULTON<sup>76</sup>. Husband of Mary Janet Hulton, sister of Beatrix Marian Hulton, mother  
 61. KITCHENER THOMAS JOSEPH GILL<sup>78</sup>. Husband of Margaret (Meg) Hulton, sister of Beatrix Marian Hulton, mother  
 62. BRIAN JOSEPH GILL<sup>58</sup>. Son of Margaret (Meg) Hulton, sister of Beatrix Marian Hulton, mother  
 63. CATHERINE GILL<sup>55</sup>. Daughter of Margaret (Meg) Hulton, sister of Beatrix Marian Hulton, mother  
 64. DAWN WILSON<sup>9</sup>. Wife of Simon Andrew Woods, son of Richard George Woods, brother  
 65. KIRSTEN UNKNOWN<sup>7</sup>. Wife of Alastair Richard Woods, son of Richard George Woods, brother  
 66. CONNOR WOODS<sup>1</sup>. Son of Alastair Richard Woods, son of Richard George Woods, brother  
 67. DAVID ROWSON<sup>5</sup>. Husband of Jennifer Clare Woods, daughter of Richard George Woods, brother

**3 STEPS REMOVED**

68. HENRY PRESTON WOODS<sup>97</sup>. Father of James Woods, father of James Anthony Woods, father of Peter Anthony Woods, father  
 69. JANE REYNOLDS<sup>98</sup>. Mother of James Woods, father of James Anthony Woods, father of Peter Anthony Woods, father  
 70. ANTHONY SHAW<sup>99</sup>. Father of Elizabeth Ann Shaw, mother of James Anthony Woods, father of Peter Anthony Woods, father  
 71. ELIZABETH EDWARDS<sup>100</sup>. Mother of Elizabeth Ann Shaw, mother of James Anthony Woods, father of Peter Anthony Woods, father  
 72. JOSEPH PARKER<sup>101</sup>. Father of Henry Parker, father of Lucy Ellen Marguerita Parker, mother of Peter Anthony Woods, father  
 73. RUTH COWARD<sup>102</sup>. Mother of Henry Parker, father of Lucy Ellen Marguerita Parker, mother of Peter Anthony Woods, father  
 74. PETER MELROSE<sup>103</sup>. Father of Jane Ellen Archbold Smailes Melrose, mother of Lucy Ellen Marguerita Parker, mother of Peter Anthony Woods, father  
 75. MARGARET SMAILES<sup>104</sup>. Mother of Jane Ellen Archbold Smailes Melrose, mother of Lucy Ellen Marguerita Parker, mother of Peter Anthony Woods, father  
 76. SEAN P MCDONALD<sup>49</sup>. Husband of Amanda Helen Woods, daughter of Alan Robert Woods, brother of Peter Anthony Woods, father  
 77. CONNOR ALAN MCDONALD<sup>21</sup>. Son of Amanda Helen Woods, daughter of Alan Robert Woods, brother of Peter Anthony Woods, father  
 78. CALLUM SEAN MCDONALD<sup>20</sup>. Son of Amanda Helen Woods, daughter of Alan Robert Woods, brother of Peter Anthony Woods, father  
 79. VERONICA ANN CAIRNS<sup>36</sup>. Wife of David Taylor, son of Elizabeth Helen Woods, sister of Peter Anthony Woods, father  
 80. MARGARET M SWARBRICK<sup>38</sup>. Wife of John A Taylor, son of Elizabeth Helen Woods, sister of Peter Anthony Woods, father  
 81. JAMES WILLIAM TAYLOR<sup>17</sup>. Son of John A Taylor, son of Elizabeth Helen Woods, sister of Peter Anthony Woods, father  
 82. ROBERT TAYLOR<sup>13</sup>. Son of David Taylor, son of Elizabeth Helen Woods, sister of Peter Anthony Woods, father  
 83. JENNIFER TAYLOR<sup>15</sup>. Daughter of David Taylor, son of Elizabeth Helen Woods, sister of Peter Anthony Woods, father  
 84. LYNNE MARGARET TAYLOR<sup>18</sup>. Daughter of John A Taylor, son of Elizabeth Helen Woods, sister of Peter Anthony Woods, father  
 85. THOMAS B LOGUE<sup>34</sup>. Husband of Rosemary Hopkins, daughter of Elizabeth Helen Woods, sister of Peter Anthony Woods, father  
 86. LEONARD STEWART TAYLOR<sup>42</sup>. Husband of Gillian Saunders, daughter of Jean Margaret Woods, sister of Peter Anthony Woods, father  
 87. RAYMOND LISTER<sup>40</sup>. Husband of Gail Saunders, daughter of Jean Margaret Woods, sister of Peter Anthony Woods, father  
 88. VINCENT UNKNOWN<sup>44</sup>. Husband of Kathleen Graham, daughter of Barbara M Woods, sister of Peter Anthony Woods, father  
 89. MICHAEL A LOGUE<sup>10</sup>. Son of Rosemary Hopkins, daughter of Elizabeth Helen Woods, sister of Peter Anthony Woods, father  
 90. GEORGINA AUDREY LISTER<sup>19</sup>. Daughter of Gail Saunders, daughter of Jean Margaret Woods, sister of Peter Anthony Woods, father  
 91. HELEN JOSEPHINE LOGUE<sup>11</sup>. Daughter of Rosemary Hopkins, daughter of Elizabeth Helen Woods, sister of Peter Anthony Woods, father

**3 STEPS REMOVED (Continued)**

92. CATHERINE ALICE LOGUE<sup>12</sup>. Daughter of Rosemary Hopkins, daughter of Elizabeth Helen Woods, sister of Peter Anthony Woods, father
93. CHARLES NORLEIGH HULTON<sup>105</sup>. Father of William Ford Ralph Hulton, father of Frederick Blethyn Hulton, father of Beatrix Marian Hulton, mother
94. MARY ANN WATSON<sup>106</sup>. Mother of William Ford Ralph Hulton, father of Frederick Blethyn Hulton, father of Beatrix Marian Hulton, mother
95. RICHARD THOMAS HUNT<sup>107</sup>. Father of Marian Hunt, mother of Frederick Blethyn Hulton, father of Beatrix Marian Hulton, mother
96. ELIZABETH WILLIS<sup>108</sup>. Mother of Marian Hunt, mother of Frederick Blethyn Hulton, father of Beatrix Marian Hulton, mother
97. JOHN TAYLOR<sup>109</sup>. Father of John Benjamin Taylor, father of Mary Annie Taylor, mother of Beatrix Marian Hulton, mother
98. MARY ATLAY<sup>110</sup>. Mother of John Benjamin Taylor, father of Mary Annie Taylor, mother of Beatrix Marian Hulton, mother
99. WILLIAM ROBSON<sup>111</sup>. Father of Mary Jennet Robson, mother of Mary Annie Taylor, mother of Beatrix Marian Hulton, mother
100. JENNET MACKAY<sup>112</sup>. Mother of Mary Jennet Robson, mother of Mary Annie Taylor, mother of Beatrix Marian Hulton, mother
101. JUDY SOPHER<sup>51</sup>. Wife of Mr. Hulton, son of Frederick John Hulton, brother of Beatrix Marian Hulton, mother
102. CORRIE HULTON<sup>22</sup>. Daughter of Mr. Hulton, son of Frederick John Hulton, brother of Beatrix Marian Hulton, mother
103. TRACY HULTON<sup>23</sup>. Daughter of Mr. Hulton, son of Frederick John Hulton, brother of Beatrix Marian Hulton, mother
104. JACK ANDERSON<sup>54</sup>. Husband of Patricia Hulton, daughter of Frederick John Hulton, brother of Beatrix Marian Hulton, mother
105. DANA ANDERSON<sup>24</sup>. Son of Patricia Hulton, daughter of Frederick John Hulton, brother of Beatrix Marian Hulton, mother
106. SEAN ANDERSON<sup>25</sup>. Son of Patricia Hulton, daughter of Frederick John Hulton, brother of Beatrix Marian Hulton, mother
107. JUDITH IRIS<sup>59</sup>. Wife of Brian Joseph Gill, son of Margaret (Meg) Hulton, sister of Beatrix Marian Hulton, mother
108. BRUCE LABELLE<sup>56</sup>. Husband of Catherine Gill, daughter of Margaret (Meg) Hulton, sister of Beatrix Marian Hulton, mother
109. GRAHAM LEWIS<sup>57</sup>. Husband of Catherine Gill, daughter of Margaret (Meg) Hulton, sister of Beatrix Marian Hulton, mother

**4 STEPS REMOVED**

110. LAURA UNKNOWN<sup>14</sup>. Wife of Robert Taylor, son of David Taylor, son of Elizabeth Helen Woods, sister of Peter Anthony Woods, father
111. CHRIS HESLOP<sup>16</sup>. Husband of Jennifer Taylor, daughter of David Taylor, son of Elizabeth Helen Woods, sister of Peter Anthony Woods, father
112. WILLIAM HULTON<sup>113</sup>. Father of Charles Norleigh Hulton, father of William Ford Ralph Hulton, father of Frederick Blethyn Hulton, father of Beatrix Marian Hulton, mother
113. MARIA RANDLE FORD<sup>114</sup>. Mother of Charles Norleigh Hulton, father of William Ford Ralph Hulton, father of Frederick Blethyn Hulton, father of Beatrix Marian Hulton, mother

**5 STEPS REMOVED**

114. WILLIAM HULTON<sup>115</sup>. Father of William Hulton, father of Charles Norleigh Hulton, father of William Ford Ralph Hulton, father of Frederick Blethyn Hulton, father of Beatrix Marian Hulton, mother
115. JANE LANGFORD BROOKE<sup>116</sup>. Mother of William Hulton, father of Charles Norleigh Hulton, father of William Ford Ralph Hulton, father of Frederick Blethyn Hulton, father of Beatrix Marian Hulton, mother

**6 STEPS REMOVED**

116. WILLIAM HULTON<sup>118</sup>. Father of William Hulton, father of William Hulton, father of Charles Norleigh Hulton, father of William Ford Ralph Hulton, father of Frederick Blethyn Hulton, father of Beatrix Marian Hulton, mother
117. ANN HALL<sup>119</sup>. Mother of William Hulton, father of William Hulton, father of Charles Norleigh Hulton, father of William Ford Ralph Hulton, father of Frederick Blethyn Hulton, father of Beatrix Marian Hulton, mother
118. WILLIAM TYRRELL BOYCE<sup>117</sup>. Husband of Jane Langford Brooke, mother of William Hulton, father of Charles Norleigh Hulton, father of William Ford Ralph Hulton, father of Frederick Blethyn Hulton, father of Beatrix Marian Hulton, mother

**7 STEPS REMOVED**

119. WILLIAM HULTON<sup>120</sup>. Father of William Hulton, father of William Hulton, father of William Hulton, father of Charles Norleigh Hulton, father of William Ford Ralph Hulton, father of Frederick Blethyn Hulton, father of Beatrix Marian Hulton, mother
120. MARY LEIGH<sup>121</sup>. Mother of William Hulton, father of William Hulton, father of William Hulton, father of Charles Norleigh Hulton, father of William Ford Ralph Hulton, father of Frederick Blethyn Hulton, father of Beatrix Marian Hulton, mother

**8 STEPS REMOVED**

121. JESSOP HULTON<sup>122</sup>. Father of William Hulton, father of William Hulton, father of William Hulton, father of William Hulton, father of Charles Norleigh Hulton, father of William Ford Ralph Hulton, father of Frederick Blethyn Hulton, father of Beatrix Marian Hulton, mother
122. MARY HASELDEAN<sup>123</sup>. Mother of William Hulton, father of William Hulton, father of William Hulton, father of William Hulton, father of Charles Norleigh Hulton, father of William Ford Ralph Hulton, father of Frederick Blethyn Hulton, father of Beatrix Marian Hulton, mother

**9 STEPS REMOVED**

123. WILLIAM HULTON<sup>124</sup>. Father of Jessop Hulton, father of William Hulton, father of William Hulton, father of William Hulton, father of William Hulton, father of Charles Norleigh Hulton, father of William Ford Ralph Hulton, father of Frederick Blethyn Hulton, father of Beatrix Marian Hulton, mother
124. ANNE JESSOP<sup>125</sup>. Mother of Jessop Hulton, father of William Hulton, father of William Hulton, father of William Hulton, father of William Hulton, father of Charles Norleigh Hulton, father of William Ford Ralph Hulton, father of Frederick Blethyn Hulton, father of Beatrix Marian Hulton, mother

**10 STEPS REMOVED**

125. ADAM HULTON<sup>126</sup>. Father of William Hulton, father of Jessop Hulton, father of William Hulton, father of William Hulton, father of William Hulton, father of Charles Norleigh Hulton, father of William Ford Ralph Hulton, father of Frederick Blethyn Hulton, father of Beatrix Marian Hulton, mother
126. GRACE HOWARTH<sup>127</sup>. Mother of William Hulton, father of Jessop Hulton, father of William Hulton, father of William Hulton, father of William Hulton, father of Charles Norleigh Hulton, father of William Ford Ralph Hulton, father of Frederick Blethyn Hulton, father of Beatrix Marian Hulton, mother

**11 STEPS REMOVED**

127. WILLIAM HULTON<sup>128</sup>. Father of Adam Hulton, father of William Hulton, father of Jessop Hulton, father of William Hulton, father of William Hulton, father of William Hulton, father of Charles Norleigh Hulton, father of William Ford Ralph Hulton, father of Frederick Blethyn Hulton, father of Beatrix Marian Hulton, mother
128. KATHERINE HYDE<sup>129</sup>. Mother of Adam Hulton, father of William Hulton, father of Jessop Hulton, father of William Hulton, father of William Hulton, father of William Hulton, father of Charles Norleigh Hulton, father of William Ford Ralph Hulton, father of Frederick Blethyn Hulton, father of Beatrix Marian Hulton, mother

**12 STEPS REMOVED**

129. ADAM HULTON<sup>130</sup>. Father of William Hulton, father of Adam Hulton, father of William Hulton, father of Jessop Hulton, father of William Hulton, father of William Hulton, father of William Hulton, father of Charles Norleigh Hulton, father of William Ford Ralph Hulton, father of Frederick Blethyn Hulton, father of Beatrix Marian Hulton, mother
130. ALICE BAGULEY<sup>131</sup>. Mother of William Hulton, father of Adam Hulton, father of William Hulton, father of Jessop Hulton, father of William Hulton, father of William Hulton, father of William Hulton, father of Charles Norleigh Hulton, father of William Ford Ralph Hulton, father of Frederick Blethyn Hulton, father of Beatrix Marian Hulton, mother

**13 STEPS REMOVED**

131. WILLIAM (THE PATRIARCH) HULTON<sup>132</sup>. Father of Adam Hulton, father of William Hulton, father of Adam Hulton, father of William Hulton, father of Jessop Hulton, father of William Hulton, father of William Hulton, father of Charles Norleigh Hulton, father of William Ford Ralph Hulton, father of Frederick Blethyn Hulton, father of Beatrix Marian Hulton, mother
132. MARGARET KEIGHLEY<sup>133</sup>. Mother of Adam Hulton, father of William Hulton, father of Adam Hulton, father of William Hulton, father of Jessop Hulton, father of William Hulton, father of William Hulton, father of William Hulton, father of Charles Norleigh Hulton, father of William Ford Ralph Hulton, father of Frederick Blethyn Hulton, father of Beatrix Marian Hulton, mother









**28 STEPS REMOVED**

169. BLETHYN DE HULTON<sup>170</sup>. Father of Jorveth (Yarwrit) De Hulton, father of Richard De Hulton, father of David De Hulton, father of Richard De Hulton, father of Adam De Hulton, father of Roger De Hulton, father of Roger De Hulton, father of Adam De Hulton, father of Roger De Hulton, father of Roger Hulton, father of Roger Hulton, father of Adam Hulton, father of William Hulton, father of Adam Hulton, father of William (The Patriarch) Hulton, father of Adam Hulton, father of William Hulton, father of Adam Hulton, father of William Hulton, father of Jessop Hulton, father of William Hulton, father of William Hulton, father of William Hulton, father of William Hulton, father of Charles Norleigh Hulton, father of William Ford Ralph Hulton, father of Frederick Blethyn Hulton, father of Beatrix Marian Hulton, mother

**11. INDEX OF INDIVIDUALS**

<u>Ref.</u>	<u>Tree</u>	<u>Name (Relationship)</u>
7	3	UNKNOWN, Kirsten (Jane's nephew's wife <sup>65</sup> ).
14	5	..... Laura (Jane's cousin's wife, once removed <sup>110</sup> ).
44	15	..... Vincent (Jane's cousin's husband <sup>88</sup> ).
169	63	ALRETON, Christiana De, ? (Jane's twenty-six-times-great-grandmother <sup>168</sup> ).
24	18	ANDERSON, Dana (Jane's cousin, once removed <sup>105</sup> ).
54	18	..... Jack (Jane's cousin's husband <sup>104</sup> ).
25	18	..... Sean (Jane's cousin, once removed <sup>106</sup> ).
155	57	ATHERTON, Isabella (Jane's nineteen-times-great-grandmother <sup>154</sup> ).
110	33	ATLAY, Mary (Jane's great-great-grandmother <sup>98</sup> ).
131	46	BAGULEY, Alice (Jane's eleven-times-great-grandmother <sup>130</sup> ).
165	62	BLACKBURNE, Agnes De (Jane's twenty-four-times-great-grandmother <sup>164</sup> ).
76	30	BOULTON, Mr. (Jane's uncle by marriage <sup>60</sup> ).
117	39	BOYCE, William Tyrrell (Jane's step-four-times-great-grandfather <sup>118</sup> ).
116	38	BROOKE, Jane Langford (Jane's four-times-great-grandmother <sup>115</sup> ).
36	11	CAIRNS, Veronica Ann (Jane's cousin's wife <sup>79</sup> ).
102	32	COWARD, Ruth (Jane's great-great-grandmother <sup>73</sup> ).
153	56	CULCHETH, Alice De, ? (Jane's nineteen-times-great-grandmother <sup>152</sup> ).
161	60	ECCLES, Alicia De (Jane's twenty-two-times-great-grandmother <sup>160</sup> ).
100	32	EDWARDS, Elizabeth (Jane's great-great-grandmother <sup>71</sup> ).
145	53	FARNSWORTH, Helen, ? (Jane's seventeen-times-great-grandmother <sup>144</sup> ).
114	37	FORD, Maria Randle (Jane's great-great-great-grandmother <sup>113</sup> ).
143	52	GARNET, Joan (Jane's sixteen-times-great-grandmother <sup>142</sup> ).
58	31	GILL, Brian Joseph (Jane's cousin <sup>62</sup> ).
55	31	..... Catherine (Jane's cousin <sup>63</sup> ).
78	31	..... Kitchener Thomas Joseph (Jane's uncle by marriage <sup>61</sup> ).
43	27	GRAHAM, Kathleen (Jane's cousin <sup>46</sup> ).
70	27	..... Robert (Roy) J (Jane's uncle by marriage <sup>36</sup> ).
45	27	..... Stuart (Jane's cousin <sup>42</sup> ).
119	40	HALL, Ann (Jane's five-times-great-grandmother <sup>117</sup> ).
141	51	HARRINGTON, Katherine (Jane's sixteen-times-great-grandmother <sup>140</sup> ).
123	42	HASELDEAN, Mary (Jane's seven-times-great-grandmother <sup>122</sup> ).
16	6	HESLOP, Chris (Jane's cousin's husband, once removed <sup>111</sup> ).
63	23	HOPKINS, Michael A C (Jane's uncle by marriage <sup>37</sup> ).
32	23	..... Michael A E (Jane's cousin <sup>43</sup> ).
33	23	..... Rosemary (Jane's cousin <sup>44</sup> ).
127	44	HOWARTH, Grace (Jane's nine-times-great-grandmother <sup>126</sup> ).
50	29	HULTON, Mr. (Jane's cousin <sup>57</sup> ).
130	47	..... Adam (Jane's eleven-times-great-grandfather <sup>129</sup> ).
126	45	..... Adam (Jane's nine-times-great-grandfather <sup>125</sup> ).
134	49	..... Adam (Jane's thirteen-times-great-grandfather <sup>133</sup> ).
138	51	..... Adam (Jane's fifteen-times-great-grandfather <sup>137</sup> ).
152	58	..... Adam De (Jane's nineteen-times-great-grandfather <sup>151</sup> ).
160	61	..... Adam De (Jane's twenty-two-times-great-grandfather <sup>159</sup> ).
139	52	..... Alicia (Jane's fifteen-times-great-grandmother <sup>138</sup> ).
61	33	..... Beatrix Marian (Jane's mother <sup>2</sup> ).
170	63	..... Blethyn De (Jane's twenty-seven-times-great-grandfather <sup>169</sup> ).
105	37	..... Charles Norleigh (Jane's great-great-grandfather <sup>93</sup> ).
22	17	..... Corrie (Jane's cousin, once removed <sup>102</sup> ).
164	63	..... David De (Jane's twenty-four-times-great-grandfather <sup>163</sup> ).
149	57	..... Elena De (Jane's eighteen-times-great-grandmother <sup>148</sup> ).
80	33	..... Elizabeth Hunt (Libby) (Jane's aunt <sup>19</sup> ).
83	34	..... Frederick Blethyn (Jane's grandfather <sup>15</sup> ).
73	33	..... Frederick John (Jane's uncle <sup>17</sup> ).
150	57	..... James De (Jane's eighteen-times-great-grandfather <sup>149</sup> ).
52	29	..... James William (Jane's cousin <sup>58</sup> ).
122	43	..... Jessop (Jane's seven-times-great-grandfather <sup>121</sup> ).
142	54	..... John (Jane's sixteen-times-great-grandfather <sup>141</sup> ).
154	57	..... John De (Jane's nineteen-times-great-grandfather <sup>153</sup> ).
168	63	..... Jorveth (Yarwrit) De (Jane's twenty-six-times-great-grandfather <sup>167</sup> ).
77	33	..... Margaret (Meg) (Jane's aunt <sup>21</sup> ).

<u>Ref.</u>	<u>Tree</u>	<u>Name (Relationship)</u>
75	33	HULTON, Mary Janet (Jane's aunt <sup>20</sup> ).
53	29	..... Patricia (Jane's cousin <sup>59</sup> ).
79	33	..... Ralph William (Jane's uncle <sup>18</sup> ).
162	62	..... Richard De (Jane's twenty-three-times-great-grandfather <sup>161</sup> ).
166	63	..... Richard De (Jane's twenty-five-times-great-grandfather <sup>165</sup> ).
144	55	..... Roger (Jane's seventeen-times-great-grandfather <sup>143</sup> ).
140	53	..... Roger (Jane's sixteen-times-great-grandfather <sup>139</sup> ).
156	59	..... Roger De (Jane's twenty-times-great-grandfather <sup>155</sup> ).
158	60	..... Roger De (Jane's twenty-one-times-great-grandfather <sup>157</sup> ).
148	56	..... Roger De (Jane's eighteen-times-great-grandfather <sup>147</sup> ).
23	17	..... Tracy (Jane's cousin, once removed <sup>103</sup> ).
136	50	..... William (Jane's fourteen-times-great-grandfather <sup>135</sup> ).
120	42	..... William (Jane's six-times-great-grandfather <sup>119</sup> ).
146	52	..... William (Jane's seventeen-times-great-grandfather <sup>145</sup> ).
124	44	..... William (Jane's eight-times-great-grandfather <sup>123</sup> ).
128	46	..... William (Jane's ten-times-great-grandfather <sup>127</sup> ).
115	40	..... William (Jane's four-times-great-grandfather <sup>114</sup> ).
113	38	..... William (Jane's great-great-great-grandfather <sup>112</sup> ).
118	41	..... William (Jane's five-times-great-grandfather <sup>116</sup> ).
132	48	..... William (The Patriarch) (Jane's twelve-times-great-grandfather <sup>131</sup> ).
93	36	..... William Ford Ralph (Jane's great-grandfather <sup>48</sup> ).
94	33	HUNT, Marian (Jane's great-grandmother <sup>49</sup> ).
107	33	..... Richard Thomas (Jane's great-great-grandfather <sup>95</sup> ).
129	45	HYDE, Katherine (Jane's ten-times-great-grandmother <sup>128</sup> ).
59	21	IRIS, Judith (Jane's cousin's wife <sup>107</sup> ).
28	8	JAMESON, Andrew John (Jane's husband <sup>5</sup> ).
125	43	JESSOP, Anne (Jane's eight-times-great-grandmother <sup>124</sup> ).
133	47	KEIGHLEY, Margaret (Jane's twelve-times-great-grandmother <sup>132</sup> ).
56	19	LABELLE, Bruce (Jane's cousin's husband <sup>108</sup> ).
157	58	LEGH, Agnes De (Jane's twenty-times-great-grandmother <sup>156</sup> ).
137	49	..... Elizabeth (Jane's fourteen-times-great-grandmother <sup>136</sup> ).
121	41	LEIGH, Mary (Jane's six-times-great-grandmother <sup>120</sup> ).
159	59	LEVER, Alyne De (Jane's twenty-one-times-great-grandmother <sup>158</sup> ).
57	20	LEWIS, Graham (Jane's cousin's husband <sup>109</sup> ).
19	13	LISTER, Georgina Audrey (Jane's cousin, once removed <sup>90</sup> ).
40	13	..... Raymond (Jane's cousin's husband <sup>87</sup> ).
12	10	LOGUE, Catherine Alice (Jane's cousin, once removed <sup>92</sup> ).
11	10	..... Helen Josephine (Jane's cousin, once removed <sup>91</sup> ).
10	10	..... Michael A (Jane's cousin, once removed <sup>89</sup> ).
34	10	..... Thomas B (Jane's cousin's husband <sup>85</sup> ).
112	33	MACKAY, Jennet (Jane's great-great-grandmother <sup>100</sup> ).
30	9	MACKENZIE, Margaret (Jane's sister-in-law <sup>22</sup> ).
20	16	MCDONALD, Callum Sean (Jane's cousin, once removed <sup>78</sup> ).
21	16	..... Connor Alan (Jane's cousin, once removed <sup>77</sup> ).
49	16	..... Sean P (Jane's cousin's husband <sup>76</sup> ).
92	32	MELROSE, Jane Ellen Archbold Smailes (Jane's great-grandmother <sup>30</sup> ).
103	32	..... Peter (Jane's great-great-grandfather <sup>74</sup> ).
135	48	NORRIS, Clemence (Jane's thirteen-times-great-grandmother <sup>134</sup> ).
91	32	PARKER, Henry (Jane's great-grandfather <sup>29</sup> ).
101	32	..... Joseph (Jane's great-great-grandfather <sup>72</sup> ).
82	32	..... Lucy Ellen Marguerita (Jane's grandmother <sup>9</sup> ).
66	25	PRICE, Mary (Jane's aunt by marriage <sup>32</sup> ).
151	52	RADCLIFFE, Elizabeth (Jane's eighteen-times-great-grandmother <sup>150</sup> ).
163	61	RADCLIVE, Margeria (Jane's twenty-three-times-great-grandmother <sup>162</sup> ).
98	32	REYNOLDS, Jane (Jane's great-great-grandmother <sup>69</sup> ).
167	63	RIDICHE, Ellen, ? (Jane's twenty-five-times-great-grandmother <sup>166</sup> ).
96	33	ROBSON, Mary Jennet (Jane's great-grandmother <sup>51</sup> ).
111	33	..... William (Jane's great-great-grandfather <sup>99</sup> ).
5	2	ROWSON, David (Jane's niece's husband <sup>67</sup> ).
39	26	SAUNDERS, Gail (Jane's cousin <sup>45</sup> ).

<u>Ref.</u>	<u>Tree</u>	<u>Name (Relationship)</u>
68	26	SAUNDERS, George A (Jane's uncle by marriage <sup>38</sup> ).
41	26	..... Gillian (Jane's cousin <sup>47</sup> ).
99	32	SHAW, Anthony (Jane's great-great-grandfather <sup>70</sup> ).
90	32	..... Elizabeth Ann (Jane's great-grandmother <sup>28</sup> ).
3	1	SLACK, Michael Lee (Jane's son-in-law <sup>26</sup> ).
104	32	SMAILES, Margaret (Jane's great-great-grandmother <sup>75</sup> ).
74	29	SMIBERT, Margaret Helen (Jane's aunt by marriage <sup>56</sup> ).
51	17	SOPHER, Judy (Jane's cousin's wife <sup>101</sup> ).
38	12	SWARBRICK, Margaret M (Jane's cousin's wife <sup>80</sup> ).
86	35	TAYLOR, Alice M (Jane's great-aunt <sup>54</sup> ).
35	24	..... David (Jane's cousin <sup>40</sup> ).
17	12	..... James William (Jane's cousin, once removed <sup>81</sup> ).
85	35	..... Janet Isabel (Jane's great-aunt <sup>53</sup> ).
15	11	..... Jennifer (Jane's cousin, once removed <sup>83</sup> ).
109	33	..... John (Jane's great-great-grandfather <sup>97</sup> ).
37	24	..... John A (Jane's cousin <sup>41</sup> ).
95	33	..... John Benjamin (Jane's great-grandfather <sup>50</sup> ).
87	35	..... John W (Jane's great-uncle <sup>52</sup> ).
42	14	..... Leonard Stewart (Jane's cousin's husband <sup>86</sup> ).
18	12	..... Lynne Margaret (Jane's cousin, once removed <sup>84</sup> ).
84	35	..... Mary Annie (Jane's grandmother <sup>16</sup> ).
88	35	..... Norah (Jane's great-aunt <sup>55</sup> ).
13	11	..... Robert (Jane's cousin, once removed <sup>82</sup> ).
64	24	..... Whitendale (Jane's uncle by marriage <sup>39</sup> ).
147	54	TYLDESLEY, Margaret (Jane's seventeen-times-great-grandmother <sup>146</sup> ).
72	28	WALTON, Hazel (Jane's aunt by marriage <sup>31</sup> ).
106	36	WATSON, Mary Ann (Jane's great-great-grandmother <sup>94</sup> ).
27	7	WATTS, Martin Craig (Jane's husband <sup>6</sup> ).
2	7	..... Rachel Jane (Jane's daughter <sup>7</sup> ).
108	33	WILLIS, Elizabeth (Jane's great-great-grandmother <sup>96</sup> ).
9	4	WILSON, Dawn (Jane's nephew's wife <sup>64</sup> ).
71	32	WOODS, Alan Robert (Jane's uncle <sup>10</sup> ).
6	9	..... Alastair Richard (Jane's nephew <sup>24</sup> ).
48	28	..... Amanda Helen (Jane's cousin <sup>35</sup> ).
69	32	..... Barbara M (Jane's aunt <sup>14</sup> ).
1	3	..... Connor (Jane's great-nephew <sup>66</sup> ).
62	32	..... Elizabeth Helen (Jane's aunt <sup>13</sup> ).
97	32	..... Henry Preston (Jane's great-great-grandfather <sup>68</sup> ).
89	32	..... James (Jane's great-grandfather <sup>27</sup> ).
81	32	..... James Anthony (Jane's grandfather <sup>8</sup> ).
26	22	..... Jane Elizabeth (The subject of this report).
67	32	..... Jean Margaret (Jane's aunt <sup>12</sup> ).
4	9	..... Jennifer Clare (Jane's niece <sup>25</sup> ).
65	32	..... John James Melrose (Jane's uncle <sup>11</sup> ).
47	28	..... Nerys (Jane's cousin <sup>34</sup> ).
46	28	..... Paula (Jane's cousin <sup>33</sup> ).
60	32	..... Peter Anthony (Jane's father <sup>1</sup> ).
31	22	..... Peter John (Jane's brother <sup>4</sup> ).
29	22	..... Richard George (Jane's brother <sup>3</sup> ).
8	9	..... Simon Andrew (Jane's nephew <sup>23</sup> ).

## **Hoshika, Our Family Star**

Amid our branches, strong and wide,  
A little fox-like soul resides.  
With pricked-up ears and knowing eyes,  
She wags her tail, our hearts she ties.

Through every laugh, through every year,  
Her gentle paws have trotted near.  
A guardian bright, so bold, so true—  
Hoshika, we are home with you.

## **A Genealogy Report For**

# **MY STAR IN THE SKY HOSHIKA**





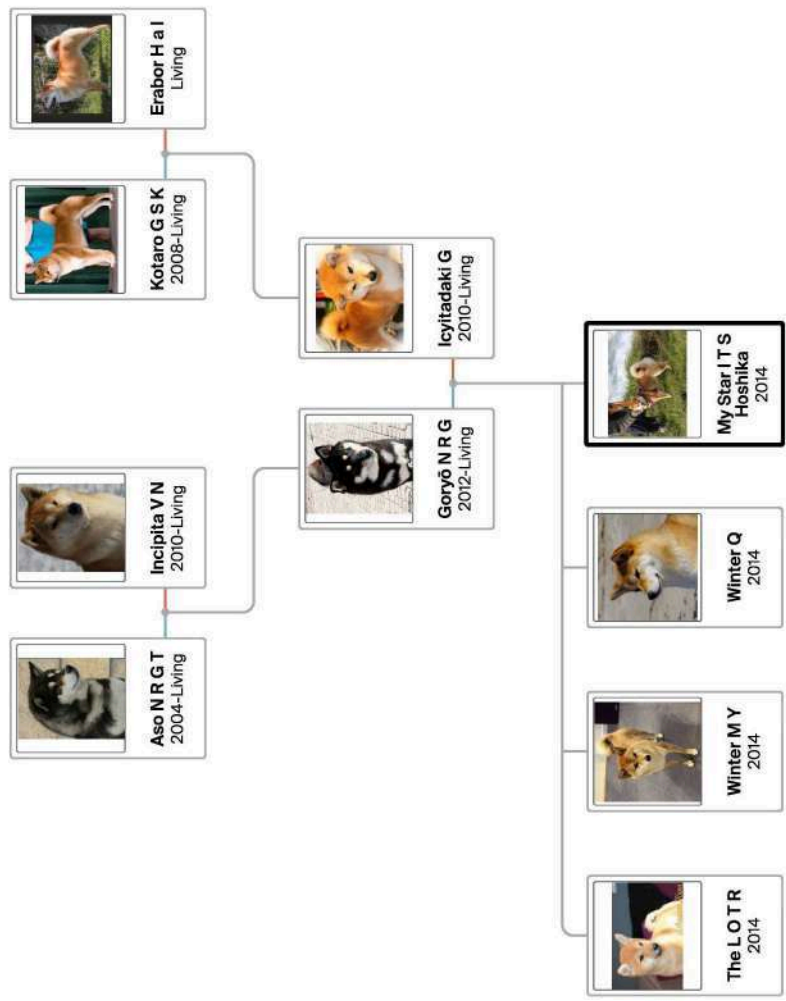



**CONTENTS**

- 1. INTRODUCTION**
- 2. PATERNAL ANCESTRY**
- 3. MATERNAL ANCESTRY**
- 4. DIRECT RELATIONS**
- 5. FAMILY TREE**
- 6. INDEX OF PLACES**
- 7. INDEX OF DATES**
- 8. INDEX OF ANNIVERSARIES**
- 9. RELATIONSHIP PATHS**
- 10. INDEX OF INDIVIDUALS**





**1. INTRODUCTION**

**STATISTICS**

This document reports the details of 10 individuals, of which 4 are male and 6 are female.

There are 3 families reported. 3 of these families are reported as having children, with an average of 2 children per family.

**THE NARRATIVE SECTIONS**

The "Direct Relations" section reports the details of individuals who have a direct family connection to My Star In The Sky Hoshika<sup>1</sup>. The section is broken into sub-sections for each generation, within which the individuals are listed in order of closeness of relationship. The sequence numbers are used throughout the document to cross-reference back to the detailed entry of an individual.

With a narrative section, each generation is shown as a separate subsection, within which the individuals are listed in order of the closeness of their relationship to My Star In The Sky Hoshika<sup>1</sup>.

**FAMILY TREES SECTION**

Each family tree shows the reported children, parents, grandparents and great-grandparents of a family group. In order to reduce redundancy, any family group which is wholly included within another family tree may not be reported separately.

Above each of the great-grandparent boxes (top row), a continuation family tree reference number is shown if the great-grandparent is recorded as a child in the continuation tree. A continuation reference number is also shown to the left of a grandparent or parent box if that individual has siblings reported in the continuation tree; and beneath a child box (bottom row) if that individual has children reported in the continuation tree.

**2. PATERNAL ANCESTRY**

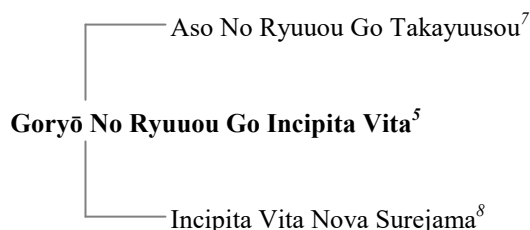

**3. MATERNAL ANCESTRY**

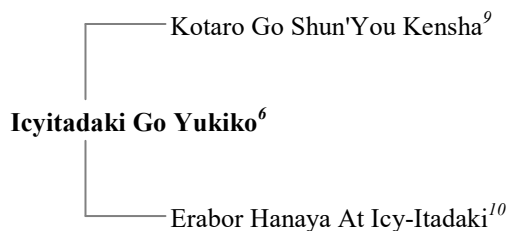

#### **4. DIRECT RELATIONS**

##### **Generation of Peers**

1. MY STAR IN THE SKY HOSHIKA (The subject of this report) was born on 12 September 2014, in Cartagena, Murcia, Spain, to Goryō No Ryuuou Go Incipita Vita<sup>5</sup> and Icyitadaki Go Yukiko<sup>6</sup>, as shown in family tree 1.



2. WINTER QUEEN (Hoshika's sister<sup>4</sup>) was born on 12 September 2014, in Cartagena, Murcia, Spain, to Goryō No Ryuuou Go Incipita Vita<sup>5</sup> and Icyitadaki Go Yukiko<sup>6</sup>, as shown in family tree 1.



3. THE LORD OF THE RINGS (Hoshika's brother<sup>3</sup>) was born on 12 September 2014, in Cartagena, Murcia, Spain, to Goryō No Ryuuou Go Incipita Vita<sup>5</sup> and Icyitadaki Go Yukiko<sup>6</sup>, as shown in family tree 1.



4. WINTER MAGIC YUKIKO (Hoshika's sister<sup>5</sup>) was born on 12 September 2014, in Cartagena, Murcia, Spain, to Goryō No Ryuuou Go Incipita Vita<sup>5</sup> and Icyitadaki Go Yukiko<sup>6</sup>, as shown in family tree 1.



##### **Generation of Parents**

5. GORYŌ NO RYUUOU GO INCIPITA VITA (Hoshika's father<sup>1</sup>, see Paternal Ancestry) was born on 11 September 2012, in Spain, to Aso No Ryuuou Go Takayuusou<sup>7</sup> and Incipita Vita Nova Surejama<sup>8</sup>, as shown within family tree 1.



6. ICYITADAKI GO YUKIKO (Hoshika's mother<sup>2</sup>, see Maternal Ancestry) was born on 2 February 2010, in Hungary, to Kotaro Go Shun'You Kensha<sup>9</sup> and Erabor Hanaya At Icy-Itadaki<sup>10</sup>, as shown within family tree 1.



Goryō No Ryuuou Go Incipita Vita<sup>5</sup> and Icyitadaki Go Yukiko had four puppies:

Winter Queen<sup>2</sup> in 2014

The Lord Of The Rings<sup>3</sup> in 2014

Winter Magic Yukiko<sup>4</sup> in 2014

My Star In The Sky Hoshika<sup>1</sup> in 2014

*This family is shown as family tree 1.*

##### **Generation of Grandparents**

7. ASO NO RYUUOU GO TAKAYUUSOU (Hoshika's grandfather<sup>6</sup>, see Paternal Ancestry) was born on 20 August 2004, in Japan.



8. INCIPITA VITA NOVA SUREJAMA (Hoshika's grandmother<sup>7</sup>, see Paternal Ancestry) was born on 30 October 2010, in Czech Republic.



Aso No Ryuuou Go Takayuusou<sup>7</sup> and Incipita Vita Nova Surejama had one male pup:

Goryō No Ryuuou Go Incipita Vita<sup>5</sup> in 2012

*This family is shown within family tree 1.*

9. KOTARO GO SHUN'YOU KENSHA (Hoshika's grandfather<sup>8</sup>, see Maternal Ancestry) was born on 12 September 2008, in Spain.



10. ERABOR HANAYA AT ICY-ITADAKI (Hoshika's grandmother<sup>9</sup>, see Maternal Ancestry) was born in Hungary.



Erabor resided in Hungary.

Kotaro Go Shun'You Kensha<sup>9</sup> and Erabor Hanaya At Icy-Itadaki had one female pup:

Icyitadaki Go Yukiko<sup>6</sup> in 2010

*This family is shown within family tree 1.*

## 5. FAMILY TREE

### 1. Goryō No Ryyuou Go Incipita Vita and Icyitadaki Go Yukiko

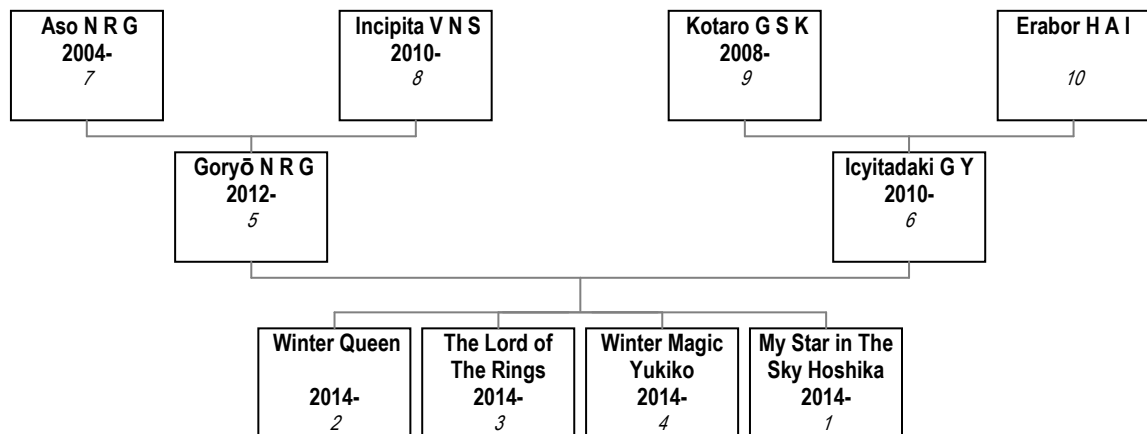

## 6. INDEX OF PLACES

### **CZECH REPUBLIC**

Birth of Incipita Vita Nova Surejama<sup>8</sup> on 30 October 2010.

### **HUNGARY**

Birth of Erabor Hanaya At Icy-Itadaki<sup>10</sup>.

Residence of Erabor Hanaya At Icy-Itadaki<sup>10</sup>.

Birth of Icyitadaki Go Yukiko<sup>6</sup> on 2 February 2010.

### **JAPAN**

Birth of Aso No Ryyuou Go Takayuousou<sup>7</sup> on 20 August 2004.

### **SPAIN**

Birth of Kotaro Go Shun'You Kensha<sup>9</sup> on 12 September 2008.

Birth of Goryō No Ryyuou Go Incipita Vita<sup>5</sup> on 11 September 2012.

### **SPAIN, MURCIA, CARTAGENA**

Birth of Winter Queen<sup>2</sup> on 12 September 2014.

Birth of Winter Magic Yukiko<sup>4</sup> on 12 September 2014.

Birth of The Lord Of The Rings<sup>3</sup> on 12 September 2014.

Birth of My Star In The Sky Hoshika<sup>1</sup> on 12 September 2014.

## 7. INDEX OF DATES

### **2004**

Birth of Aso No Ryuuou Go Takayuousou<sup>7</sup> on 20 August, in Japan.

### **2008**

Birth of Kotaro Go Shun'You Kensha<sup>9</sup> on 12 September, in Spain.

### **2010**

Birth of Icyitadaki Go Yukiko<sup>6</sup> on 2 February, in Hungary.

Birth of Incipita Vita Nova Surejama<sup>8</sup> on 30 October, in Czech Republic.

### **2012**

Birth of Goryō No Ryuuou Go Incipita Vita<sup>5</sup> on 11 September, in Spain.

### **2014**

Birth of The Lord Of The Rings<sup>3</sup> on 12 September, in Cartagena, Murcia, Spain.

Birth of Winter Queen<sup>2</sup> on 12 September, in Cartagena, Murcia, Spain.

Birth of My Star In The Sky Hoshika<sup>1</sup> on 12 September, in Cartagena, Murcia, Spain.

Birth of Winter Magic Yukiko<sup>4</sup> on 12 September, in Cartagena, Murcia, Spain.

## 8. INDEX OF ANNIVERSARIES

### **FEBRUARY**

2. Birth of Icyitadaki Go Yukiko<sup>6</sup> in Hungary, in 2010

### **AUGUST**

20. Birth of Aso No Ryuuou Go Takayuousou<sup>7</sup> in Japan, in 2004

### **SEPTEMBER**

11. Birth of Goryō No Ryuuou Go Incipita Vita<sup>5</sup> in Spain, in 2012

12. Birth of Kotaro Go Shun'You Kensha<sup>9</sup> in Spain, in 2008

Birth of My Star In The Sky Hoshika<sup>1</sup> in Cartagena, Murcia, Spain, in 2014

Birth of Winter Magic Yukiko<sup>4</sup> in Cartagena, Murcia, Spain, in 2014

Birth of Winter Queen<sup>2</sup> in Cartagena, Murcia, Spain, in 2014

Birth of The Lord Of The Rings<sup>3</sup> in Cartagena, Murcia, Spain, in 2014

### **OCTOBER**

30. Birth of Incipita Vita Nova Surejama<sup>8</sup> in Czech Republic, in 2010

## 9. RELATIONSHIP PATHS

This section details the relationship of each connected individual to My Star In The Sky Hoshika.

To facilitate cross-referencing, the relationship reference number in this section is shown with the relationship description within the other sections.

### **IMMEDIATE FAMILY**

1. GORYŌ NO RYUUOU GO INCIPITA VITA<sup>5</sup>. Father.

2. ICYITADAKI GO YUKIKO<sup>6</sup>. Mother.

3. THE LORD OF THE RINGS<sup>3</sup>. Brother.

4. WINTER QUEEN<sup>2</sup>. Sister.

5. WINTER MAGIC YUKIKO<sup>4</sup>. Sister.

### **1 STEP REMOVED**

6. ASO NO RYUUOU GO TAKAYUUSOU<sup>7</sup>. Father's father.

7. INCIPITA VITA NOVA SUREJAMA<sup>8</sup>. Father's mother.

8. KOTARO GO SHUN'YOU KENSHA<sup>9</sup>. Mother's father.

9. ERABOR HANAYA AT ICY-ITADAKI<sup>10</sup>. Mother's mother.

**10. INDEX OF INDIVIDUALS**

<u>Ref.</u>	<u>Tree</u>	<u>Name (Relationship)</u>
7	1	..... Aso No Ryuuou Go Takayuusou (Hoshika’s grandfather <sup>6</sup> ).
10	1	..... Erabor Hanaya At Icy-Itadaki (Hoshika’s grandmother <sup>9</sup> ).
5	1	..... Goryō No Ryuuou Go Incipita Vita (Hoshika’s father <sup>1</sup> ).
6	1	..... Icyitadaki Go Yukiko (Hoshika’s mother <sup>2</sup> ).
8	1	..... Incipita Vita Nova Surejama (Hoshika’s grandmother <sup>7</sup> ).
9	1	..... Kotaro Go Shun’You Kensha (Hoshika’s grandfather <sup>8</sup> ).
3	1	..... The Lord Of The Rings (Hoshika’s brother <sup>3</sup> ).
4	1	..... Winter Magic Yukiko (Hoshika’s sister <sup>5</sup> ).
2	1	..... Winter Queen (Hoshika’s sister <sup>4</sup> ).
1	1	HOSHIKA, My Star In The Sky (The subject of this report).

